

STATE OF NEBRASKA CONTRACT AMENDMENT

State Purchasing Bureau
1526 K Street, Suite 130
Lincoln, Nebraska 68508

Telephone: (402) 471-6500
Fax: (402) 471-2089

PAGE 1 of 1	ORDER DATE 06/03/19
BUSINESS UNIT 9000	BUYER JOSHUA RIEKENBERG (AS)
VENDOR NUMBER: 553151	
VENDOR ADDRESS: VALK MANUFACTURING COMPANY PO BOX 428 NEW KINGSTOWN PA 17072-0428	

CONTRACT NUMBER
15161 OC

THE CONTRACT PERIOD IS:

DECEMBER 31, 2023 THROUGH MARCH 31, 2024

THIS CONTRACT HAS BEEN AMENDED PER THE FOLLOWING INFORMATION:

NO ACTION ON THE PART OF THE CONTRACTOR NEEDS TO BE TAKEN AT THIS TIME. ORDERS FOR THE MATERIALS AND/OR SERVICES WILL BE MADE AS NEEDED BY THE VARIOUS AGENCIES OF THE STATE.

THIS CONTRACT IS NOT AN EXCLUSIVE CONTRACT TO FURNISH THE MATERIALS AND/OR SERVICES SHOWN BELOW, AND DOES NOT PRECLUDE THE PURCHASE OF SIMILAR MATERIALS AND/OR SERVICES FROM OTHER SOURCES.

THE STATE RESERVES THE RIGHT TO EXTEND THE PERIOD OF THIS CONTRACT BEYOND THE TERMINATION DATE WHEN MUTUALLY AGREEABLE TO THE CONTRACTOR AND THE STATE OF NEBRASKA.

15161 OC Valk Manufacturing Company verbiage

Awarded from NASPO Master Agreement No. 29018

Contract to supply and deliver Snow plow Blade cutting Edges to State of Nebraska agencies for the period of December 31, 2023 through March 31, 2024 .

Payment Terms: Net 45

For the File: This RFP and Contract are bid and awarded by the State of Vermont, on behalf of NASPO ValuePoint. All backup bids, etc are retained by the State of Vermont, Buildings and General Services, Office of Purchasing and Contracting. The NASPO ValuePoint/Snowplow Blade cutting Edges Master Agreement became effective June 30, 2015.

Vendor Contact: Dan Cribari
Phone: (717) 766-0711 ext 122
Fax: 717-697-6297
Email: plowsales@valkmfg.com

Amendment Six (6) as attached. (BT 01/09/23)

Line	Description	Estimated Quantity	Unit of Measure	Unit Price
1	SNOWPLOW BLADES & ACCESSORIES	1,000,000.0000	EA	1.0000

DS
RT
1/18/2024

DocuSigned by:
Joshua Riekenberg
1/18/2024
AA890823E56145E BUYER

DocuSigned by:
Amara Block
1/22/2024
4CFF2711162A4A2 MATERIEL ADMINISTRATOR

**PARTICIPATING ADDENDUM
NASPO VALUEPOINT
AMENDMENT Six (6)
(Hereinafter “Amendment”)**

Administered by the State of Vermont (hereinafter “Lead State”)

**MASTER AGREEMENT
Amendment Nine (9)**

**Valk Manufacturing Company.
Master Agreement Number #29018
(Hereinafter “Contractor”)**

and

**State of Nebraska Contract 15161 OC
(Hereinafter “Participating State/Entity”)**

THIS AMENDMENT is by and between the State of Nebraska (“Participating State/Entity”) and Valk Manufacturing Company. (Contractor).

WHEREAS, the Lead State (Vermont) has a Contract with the Contractor identified as Master Agreement Number #29018 to provide Snowplow Blade Cutting Edges for use by State Agencies and other entities. The State has entered into a Participating Addendum/Contract with the Contractor, identified as 15161 OC.

WHEREAS, the terms of the Contract specifically state that the Contract may be amended per agreement by both parties. The State of Nebraska wishes to continue to take advantage of existing contract.

NOW, THEREFORE, it is agreed by the parties to amend the Contract as follows:

Effective December 31, 2023:

1. **CHANGES:** The purpose of this Amendment Six (6) is as follows:

- a. The Contract end date, wherever such reference appears in the Contract, shall be changed from December 31,2023 to March 31, 2024.

**PARTICIPATING ADDENDUM
NASPO VALUEPOINT
AMENDMENT Six (6)
(Hereinafter "Amendment")**

Administered by the State of Vermont (hereinafter "Lead State")

**MASTER AGREEMENT
Amendment Nine (9)**

**Valk Manufacturing Company.
Master Agreement Number #29018
(Hereinafter "Contractor")**

and

**State of Nebraska Contract 15161 OC
(Hereinafter "Participating State/Entity")**

Terms and Conditions inconsistent with, contrary, or in addition to the Terms and Conditions of this Participating Addendum Amendment and the Price Agreement, together with its exhibits, shall not be added to or incorporated into this Participating Addendum Amendment or the Price Agreement and its exhibits, by any subsequent purchase order or otherwise. Any such attempts to add or incorporate such Terms and Conditions are hereby rejected. The Terms and Conditions of this Participating Addendum Amendment, the Price Agreement, and its exhibits, shall prevail and govern in the case of any such inconsistent or additional terms. This Participating Addendum Amendment applies only in the jurisdiction of the Participating State or Participating Entity, which has executed this Participating Addendum Amendment.

IN WITNESS WHEREOF, the parties have executed this Participating Addendum Amendment as of the date of execution by both parties:

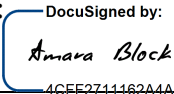
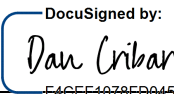
Participating State: Nebraska	Contractor: Valk Manufacturing Company
Signature:  <small>DocuSigned by: 4CFF2711162A4A2...</small>	Signature:  <small>DocuSigned by: F40EF1078FB0452...</small>
Printed Name: Amara Block	Printed Name: Dan Cribari
Title: Chief Procurement Officer	Title: sales Manager, Snow Plow Division
Date: 1/22/2024	Date: 1/16/2024

CONTRACT



Supplier 000010383
Valk Manufacturing Co
PO Box 428
New Kingstown PA 17072-0428
USA

Contract ID 000000000000000000029018	Page 1 of 8
Contract Dates 06/30/2015 to 03/31/2024	Origin CPS
Description: SNOWPLOW BLADE CUTTING EDGES	Contract Maximum \$9,999,990.00
Buyer Name William A Vivian Jr.	Buyer Phone 828-4681
Contract Status Approved	

Phone #: 717-766-0711

Line #	Item ID	Item Desc	UOM	Unit Price	Max Qty	Max Amt
1		SNOWPLOW BLADE CUTTING EDGES. CONTACT CONTRACTOR FOR PRICE QUOTE	EA	0.01000	0.00	0.00

BLADES PER THE ATTACHED LIST

STANDARD CONTRACT FOR SNOWPLOWBLADE CUTTING EDGES

1. Parties. This is a contract for services between the State of Vermont, Office of Purchasing and Contracting (hereafter called "State"), and Valk Manufacturing, with the principal place of business in New Kingstown, PA 07072, (hereafter called "Contractor"). Contractor's form of business organization is Corporation. It is the contractor's responsibility to contact the Vermont Department of Taxes to determine if, by law, the contractor is required to have a Vermont Department of Taxes Business Account Number.

2. Subject Matter. The subject matter of this contract is services generally on the subject of Snowplow Blade Cutting Edges.

3. Contract Term. The period of contractor's performance shall begin on June 30, 2015 and end on June 30, 2017, with option to renew for five (5) one year periods.

If the state exercises the option, it will provide written notice to contractor prior to the end of the term. If exercised, the provision of the option letter shall become part of and be incorporated into the original master price agreement. The total duration of this master price agreement, including the exercise of any options, shall not exceed five years.

4. Prior Approvals. If approval by the Attorney General's Office or the Secretary of Administration is required, (under current law, bulletins, and interpretations), neither this contract nor any amendment to it is binding until it has been approved by either or both such persons.

- Approval by the Attorney General's Office is required.
- Approval by the Secretary of Administration is required.
- Approval by the CIO/Commissioner DII is not required.

5. Amendment. This agreement represents the entire agreement between the parties; No changes, modifications, or amendments in the terms and conditions of this contract shall be effective unless reduced to writing, numbered and signed by the duly authorized representative of the State and Contractor.

6. Cancellation. This contract may be canceled by either party by giving written notice at least thirty (30) days in advance.

7. Attachments. This contract consists of 160 pages including the following attachments which are incorporated herein:

- Attachment A - Master Agreement Terms and Conditions
- Attachment B - Payment Provisions
- Attachment B1-Price Schedule
- Attachment C - "Standard State Provisions for Contracts and Grants" a preprinted form (revision date March 1, 2015).
- Attachment D - Snowplow Blade Cutting Edges Detailed Specifications

8. Order of Precedence. Any ambiguity, conflict or inconsistency in the Contract Documents shall be resolved according to the following order of precedence:

- (1) Standard Contract
- (2) Attachment C (Standard Contract Provisions for Contracts and Grants)
- (3) Attachment A
- (4) Attachment D

State of Vermont
 Buildings and General Services
 Office of Purchasing & Contracting
 109 State St
 Montpelier VT 05609-3001
 USA

CONTRACT



Supplier 0000010383
Valk Manufacturing Co
PO Box 428
New Kingstown PA 17072-0428
USA

Contract ID 0000000000000000000029018	Page 2 of 8
Contract Dates 06/30/2015 to 03/31/2024	Origin CPS
Description: SNOWPLOW BLADE CUTTING EDGES	Contract Maximum \$9,999,990.00
Buyer Name William A Vivian Jr.	Buyer Phone 828-4681
Contract Status Approved	

Phone #: 717-766-0711

Line #	Item ID	Item Desc	UOM	Unit Price	Max Qty	Max Amt
--------	---------	-----------	-----	------------	---------	---------

- (5) Attachment B
- (6) Attachment B1

CONTRACTOR POC:
 Dan Cribari
 Sales Manager, Snow Plow Division
 Valk Manufacturing Company
 plowsales@valkmfg.com
 Phone: (717) 766-0711 ext. 122
 Fax: (717) 697-6297

QUANTITY: THE ANNUAL VALUE AND QUANTITIES ARE ESTIMATED ONLY BASED ON PRIOR USAGE; ACTUAL PURCHASES MAY BE HIGHER OR LOWER DEPENDING ON THE STATE'S NEEDS. THE CONTRACT MAXIMUM IS NOT REFLECTIVE OF ACTUAL USAGE.

DELIVERY: RESPONSIBILITY FOR PRODUCT DELIVERY REMAINS WITH THE CONTRACTOR UNTIL THE PRODUCT IS PROPERLY DELIVERED AND SIGNED FOR IN ACCORDANCE WITH THE OFFICE OF PURCHASING & CONTRACTING TERMS AND CONDITIONS. SHIPMENTS SHALL BE SECURELY AND PROPERLY PACKED, ACCORDING TO ACCEPTED COMMERCIAL PRACTICES, WITHOUT EXTRA CHARGE FOR PACKING CASES OR OTHER CONTAINERS. SUCH CONTAINERS WILL REMAIN THE PROPERTY OF THE STATE UNLESS OTHERWISE STATED. DELIVERED GOODS THAT DO NOT CONFORM TO THE SPECIFICATIONS OR ARE NOT IN GOOD CONDITION UPON RECEIPT SHALL BE REPLACED PROMPTLY BY THE CONTRACTOR.

PRICING: ALL EQUIPMENT PRICING IS TO INCLUDE F.O.B. DELIVERY TO THE ORDERING FACILITY. NO REQUEST FOR EXTRA DELIVERY COST WILL BE HONORED. ALL EQUIPMENT SHALL BE DELIVERED ASSEMBLED, SERVICED, OILED, AND READY FOR IMMEDIATE USE, UNLESS OTHERWISE REQUESTED BY THE PURCHASING AGENCY.

QUALITY: ALL PRODUCTS PROVIDED UNDER THESE AGREEMENTS WILL BE NEW AND UNUSED, UNLESS OTHERWISE STATED. FACTORY SECONDS OR REMANUFACTURED PRODUCTS WILL NOT BE ACCEPTED UNLESS SPECIFICALLY REQUESTED BY THE PURCHASING AGENCY. ALL PRODUCTS PROVIDED BY THE CONTRACTOR MUST MEET ALL FEDERAL, STATE, AND LOCAL STANDARDS FOR QUALITY AND SAFETY REQUIREMENTS. PRODUCTS NOT MEETING THESE STANDARDS WILL BE DEEMED UNACCEPTABLE AND RETURNED TO THE CONTRACTOR FOR CREDIT AT NO CHARGE TO THE STATE.

METHOD OF ORDERING: PURCHASE ORDERS MUST BE USED TO ORDER ITEMS AVAILABLE UNDER THIS CONTRACT. IF VERBAL ORDERS ARE GIVEN A CONFIRMING PURCHASE ORDER MUST BE ISSUED.

INVOICING: ALL INVOICES ARE TO BE RENDERED BY THE CONTRACTOR ON THE VENDOR'S STANDARD BILLHEAD AND FORWARDED DIRECTLY TO THE INSTITUTION OR AGENCY ORDERING MATERIALS OR SERVICES AND SHALL SPECIFY THE ADDRESS TO WHICH PAYMENTS WILL BE SENT.

CANCELLATION: THE STATE SPECIFICALLY RESERVES THE RIGHT TO CANCEL THE CONTRACT, OR ANY PORTION THEREOF, IF, IN THE OPINION OF ITS COMMISSIONER OF BUILDINGS AND GENERAL SERVICES, THE SERVICES OR MATERIALS SUPPLIED BY THE CONTRACTOR ARE NOT SATISFACTORY OR ARE NOT CONSISTENT WITH THE TERMS OF THE CONTRACT

DEFAULT: IN CASE OF DEFAULT OF THE CONTRACTOR, THE STATE MAY PROCURE THE MATERIALS OR SUPPLIES FROM OTHER SOURCES AND HOLD THE CONTRACTOR RESPONSIBLE FOR ANY EXCESS COST OCCASIONED THEREBY, PROVIDED, THAT IF PUBLIC NECESSITY REQUIRES THE USE OF MATERIALS OR SUPPLIES NOT CONFORMING TO THE SPECIFICATIONS THEY MAY BE ACCEPTED AND PAYMENT THEREFORE SHALL BE MADE AT A PROPER REDUCTION IN PRICE.

CONTRACT TERMS: THIS CONTRACT WILL BE SUBJECT TO REVIEW THROUGHOUT ITS TERM. THE STATE WILL CONSIDER CANCELLATION UPON DISCOVERY THAT A VENDOR IS IN VIOLATION OF ANY PORTION OF THE AGREEMENT, INCLUDING AN INABILITY BY THE VENDOR TO PROVIDE THE PRODUCTS, SUPPORT, AND/OR SERVICE OFFERED IN THEIR RESPONSE.

VERMONT STATE COLLEGES: THIS CONTRACT IS ALSO AVAILABLE FOR USE BY THE UNIVERSITY OF VERMONT AND THE VERMONT STATE COLLEGES INC., A SEPARATE CORPORATION, HAVING UNDER ITS JURISDICTION CASTLETON STATE COLLEGE, JOHNSON STATE COLLEGE, LYNDON STATE COLLEGE, COMMUNITY COLLEGE OF VERMONT, AND THE VERMONT TECHNICAL COLLEGE.

TOWNS AND SCHOOLS OF THE STATE OF VERMONT: AT THE BIDDER'S ELECTION POLITICAL SUBDIVISIONS AND INDEPENDENT COLLEGES OF THE STATE MAY PARTICIPATE IN STATE CONTRACTS AT THE SAME PRICES, TERMS AND CONDITIONS. ITEMS FURNISHED TO POLITICAL SUBDIVISIONS AND INDEPENDENT COLLEGES WILL BE BILLED DIRECTLY TO AND PAID FOR BY THE POLITICAL SUBDIVISIONS OR INDEPENDENT COLLEGES AND NEITHER THE STATE NOR ITS COMMISSIONER OF BUILDINGS AND GENERAL SERVICES PERSONALLY OR OFFICIALLY ASSUMES ANY RESPONSIBILITY FOR THESE PAYMENTS.

CONTRACT



Supplier 0000010383
Valk Manufacturing Co
PO Box 428
New Kingstown PA 17072-0428
USA

Contract ID 0000000000000000000029018	Page 3 of 8
Contract Dates 06/30/2015 to 03/31/2024	Origin CPS
Description: SNOWPLOW BLADE CUTTING EDGES	Contract Maximum \$9,999,990.00
Buyer Name William A Vivian Jr.	Buyer Phone 828-4681
Contract Status Approved	

Phone #: 717-766-0711

Line #	Item ID	Item Desc	UOM	Unit Price	Max Qty	Max Amt
--------	---------	-----------	-----	------------	---------	---------

AGENCIES & DEPARTMENTS ARE REQUESTED TO ADVISE THE PURCHASING AGENT AT ONCE OF THE FAILURE ON THE PART OF THE CONTRACTOR TO FULFILL ANY OF THE TERMS OR CONDITIONS OF THIS CONTRACT.

PLEASE REFER TO THE ASSIGNED CONTRACT NUMBER/PURCHASE ORDER # ON ALL CORRESPONDENCE, DELIVERY DOCUMENTS AND INVOICES.

 APRIL 7, 2017
 AMENDMENT #01 - TO EXTEND CONTRACT FOR A ONE YEAR PERIOD AT THE SAME PRICES, TERMS AND CONDITIONS.

 JUNE 7, 2018
 AMENDMENT #02 - TO EXTEND CONTRACT FOR A ONE YEAR PERIOD AT THE SAME PRICES, TERMS AND CONDITIONS WITH THE FOLLOWING EXCEPTIONS:

1). PRICING: DUE TO TARIFFS ON IMPORTED STEEL CURRENTLY IN EFFECT, PLOW BLADE PRICING IS HEREBY REMOVED FROM THE ATTACHED PRODUCT LIST. ORDERING ENTITIES ARE TO REQUEST A QUOTE FROM CONTRACTOR FOR PRICING IN EFFECT AT TIME OF ORDER.

ATTACHMENT C: STANDARD STATE PROVISIONS FOR CONTRACTS AND GRANTS REVISED DECEMBER 15, 2017 IS INCORPORATED INTO THE CONTRACT.

CONTRACTOR CERTIFIES UNDER THE PAINS AND PENALTIES OF PERJURY THAT, AS OF THE DATE THIS CONTRACT AMENDMENT IS SIGNED, CONTRACTOR IS IN GOOD STANDING WITH RESPECT TO, OR IN FULL COMPLIANCE WITH A PLAN TO PAY ANY AND ALL TAXES DUE THE STATE OF VERMONT.

CERTIFICATION REGARDING SUSPENSION OR DEBARMENT. CONTRACTOR CERTIFIES UNDER THE PAINS AND PENALTIES OF PERJURY THAT, AS OF THIS DATE THIS CONTRACT AMENDMENT IS SIGNED, NEITHER PARTY NO PARTY'S PRINCIPALS (OFFICERS, DIRECTORS, OWNERS, OR PARTNERS) ARE PRESENTLY DEBARRED, SUSPENDED, PROPOSED FOR DEBARMENT, DECLARED INELIGIBLE OR EXCLUDED FROM PARTICIPATION IN FEDERAL PROGRAMS, OR PROGRAMS SUPPORTED IN WHOLE OR IN PART BY FEDERAL FUNDS.

PARTY FURTHER CERTIFIES UNDER PAINS AND PENALTIES OF PERJURY THAT, AS OF THE DATE THIS AGREEMENT IS SIGNED, PARTY IS NOT PRESENTLY DEBARRED, SUSPENDED, NOR NAMED ON THE STATE'S DEBARMENT LIST AT: [HTTP://BGS.VERMONT.GOV/PURCHASING/DEBARMENT](http://BGS.VERMONT.GOV/PURCHASING/DEBARMENT).

CHILD SUPPORT (APPLICABLE TO NATURAL PERSONS ONLY; NOT APPLICABLE TO CORPORATIONS, PARTNERSHIPS OR LLCs): CONTRACTOR IS UNDER NO OBLIGATION TO PAY CHILD SUPPORT OR IS IN GOOD STANDING WITH RESPECT TO OR IN FULL COMPLIANCE WITH A PLAN TO PAY ANY AND ALL CHILD SUPPORT PAYABLE UNDER A SUPPORT ORDER AS OF THE DATE OF THIS AMENDMENT.

 AMENDMENT#3 (MAY 2019). THIS CHANGE ORDER EXERCISES THE THIRD OF THE FIVE ONE-YEAR OPTIONS TO RENEW, AND EXTENDS THE CONTRACT FOR ONE ADDITIONAL YEAR TO 06/30/2020, AT THE SAME PRICING, TERMS, AND CONDITIONS.

STATE OF VERMONT ATTACHMENT C: STANDARD STATE CONTRACT PROVISIONS DATED DECEMBER 15, 2017 IS ATTACHED AND INCORPORATED AS PART OF THIS ORDER.

CONTRACTOR CERTIFIES UNDER THE PAINS AND PENALTIES OF PERJURY THAT AS OF THE DATE THIS AMENDMENT IS SIGNED, CONTRACT IS IN GOOD STANDING TO OR IN FULL COMPLIANCE WITH A PLAN TO PAY ANY AND ALL TAXES DUE THE STATE OF VERMONT.

CERTIFICATION REGARDING SUSPENSION OR DISBARMENT. CONTRACTOR CERTIFIES UNDER THE PAINS AND PENALTIES OF PERJURY THAT, AS OF THIS DATE THIS CONTRACT AMENDMENT IS SIGNED, NEITHER PARTY NO PARTY'S PRINCIPALS (OFFICERS, DIRECTORS, OWNERS, OR PARTNERS) ARE PRESENTLY DEBARRED, SUSPENDED, PROPOSED FOR DEBARMENT, DECLARED INELIGIBLE OR EXCLUDED FROM PARTICIPATION IN FEDERAL PROGRAMS, OR PROGRAMS SUPPORTED IN WHOLE OR IN PART BY FEDERAL FUNDS.

State of Vermont

Buildings and General Services
Office of Purchasing & Contracting
109 State St
Montpelier VT 05609-3001
USA

CONTRACT



Supplier 0000010383
Valk Manufacturing Co
PO Box 428
New Kingstown PA 17072-0428
USA

Contract ID 000000000000000000029018	Page 4 of 8
Contract Dates 06/30/2015 to 03/31/2024	Origin CPS
Description: SNOWPLOW BLADE CUTTING EDGES	Contract Maximum \$9,999,990.00
Buyer Name William A Vivian Jr.	Buyer Phone 828-4681
Contract Status Approved	

Phone #: 717-766-0711

Line #	Item ID	Item Desc	UOM	Unit Price	Max Qty	Max Amt
--------	---------	-----------	-----	------------	---------	---------

CHILD SUPPORT (APPLICABLE TO NATURAL PERSONS ONLY; NOT APPLICABLE TO CORPORATIONS, PARTNERSHIPS OR LLCs):

CONTRACTOR IS UNDER NO OBLIGATION TO PAY CHILD SUPPORT OR IS IN GOOD STANDING WITH RESPECT TO OR IN FULL COMPLIANCE WITH A PLAN TO PAY ANY AND ALL CHILD SUPPORT PAYABLE UNDER A SUPPORT ORDER AS OF THE DATE OF THIS AMENDMENT.

PARTY FURTHER CERTIFIES UNDER PAINS AND PENALTIES OF PERJURY THAT, AS OF THE DATE THIS AGREEMENT IS SIGNED, PARTY IS NOT PRESENTLY DEBARRED, SUSPENDED, NOR NAMED ON THE STATE'S DEBARMENT LIST AT: [HTTP://BGS.VERMONT.GOV/PURCHASING/DEBARMENT](http://BGS.VERMONT.GOV/PURCHASING/DEBARMENT).

STATE OF VERMONT
CONTRACT AMENDMENT #4

It is hereby agreed by and between the State of Vermont, Office of Purchasing and Contracting (the "State") and Valk Manufacturing Company Inc. , with a principal place of business in New Kingstown, PA (the "Contractor") that the contract between them originally dated as of June 30, 2015, Contract # 29018, as amended to date, (the "Contract") is hereby amended as follows:

II. Contract Term. The Contract end date, wherever such reference appears in the Contract, shall be changed from June 30, 2020 to June 30, 2021. The Contract Term may be renewed for one additional one-year period at the discretion of the State.

Taxes Due to the State. Contractor certifies under the pains and penalties of perjury that, as of the date this contract amendment is signed, the Contractor is in good standing with respect to, or in full compliance with a plan to pay, any and all taxes due the State of Vermont.

Child Support (Applicable to natural persons only; not applicable to corporations, partnerships or LLCs). Contractor is under no obligation to pay child support or is in good standing with respect to or in full compliance with a plan to pay any and all child support payable under a support order as of the date of this amendment.

Certification Regarding Suspension or Debarment. Contractor certifies under the pains and penalties of perjury that, as of the date this contract amendment is signed, neither Contractor nor Contractor's principals (officers, directors, owners, or partners) are presently debarred, suspended, proposed for debarment, declared ineligible or excluded from participation in federal programs, or programs supported in whole or in part by federal funds.

Contractor further certifies under pains and penalties of perjury that, as of the date this contract amendment is signed, Contractor is not presently debarred, suspended, nor named on the State's debarment list at: <http://bgs.vermont.gov/purchasing-contracting/debarment>

This document consists of 5 pages. Except as modified by this Amendment No. 4, all provisions of the Contract remain in full force and effect.

STATE OF VERMONT CONTACT:
BILL VIVIAN
PURCHASING AGENT
802-828-4681
FAX 802-828-2222
BILL.VIVIAN@Vermont.gov

STATE OF VERMONT June 2021
CONTRACT AMENDMENT 5

It is hereby agreed by and between the State of Vermont, Office of Purchasing and Contracting (the "State") and Valk Manufacturing Co, with a principal place of business in New Kingstown, PA (the "Contractor") that the

State of Vermont

Buildings and General Services
Office of Purchasing & Contracting
109 State St
Montpelier VT 05609-3001
USA

CONTRACT



Supplier 0000010383
Valk Manufacturing Co
PO Box 428
New Kingstown PA 17072-0428
USA

Contract ID 0000000000000000000029018	Page 5 of 8
Contract Dates 06/30/2015 to 03/31/2024	Origin CPS
Description: SNOWPLOW BLADE CUTTING EDGES	Contract Maximum \$9,999,990.00
Buyer Name William A Vivian Jr.	Buyer Phone 828-4681
Contract Status Approved	

Phone #: 717-766-0711

Line #	Item ID	Item Desc	UOM	Unit Price	Max Qty	Max Amt
--------	---------	-----------	-----	------------	---------	---------

contract between them originally dated as of June 30, 2015, Contract # 29018, as amended to date, (the "Contract") is hereby amended as follows:

I. Contract Term. The Contract end date, wherever such reference appears in the Contract, shall be changed from June 30, 2021 to June 20, 2022.

Taxes Due to the State. Contractor certifies under the pains and penalties of perjury that, as of the date this contract amendment is signed, the Contractor is in good standing with respect to, or in full compliance with a plan to pay, any and all taxes due the State of Vermont.

Child Support (Applicable to natural persons only; not applicable to corporations, partnerships or LLCs). Contractor is under no obligation to pay child support or is in good standing with respect to or in full compliance with a plan to pay any and all child support payable under a support order as of the date of this amendment.

Certification Regarding Suspension or Debarment. Contractor certifies under the pains and penalties of perjury that, as of the date this contract amendment is signed, neither Contractor nor Contractor's principals (officers, directors, owners, or partners) are presently debarred, suspended, proposed for debarment, declared ineligible or excluded from participation in federal programs, or programs supported in whole or in part by federal funds.

Contractor further certifies under pains and penalties of perjury that, as of the date this contract amendment is signed, Contractor is not presently debarred, suspended, nor named on the State's debarment list at: <http://bgs.vermont.gov/purchasing-contracting/debarment>

Sole Source Contract for Services. This Contract results from a "sole source" procurement under State of Vermont Administrative Bulletin 3.5 process and Contractor hereby certifies that it is and will remain in compliance with the campaign contribution restrictions under 17 V.S.A. § 2950.

SOV Cybersecurity Standard 19-01. All products and service provided to or for the use of the State under this Contract shall be in compliance with State of Vermont Cybersecurity Standard 19-01, which Contractor acknowledges has been provided to it, and is available on-line at the following URL:<https://digitalservices.vermont.gov/cybersecurity/cybersecurity-standards-and-directives>

This document consists of 6 pages. Except as modified by this Amendment No. 5, all provisions of the Contract remain in full force and effect.

STATE OF VERMONT July 2021
CONTRACT AMENDMENT 6

It is hereby agreed by and between the State of Vermont, Office of Purchasing and Contracting (the "State") and Valk Manufacturing Co, with a principal place of business in New Kingstown, PA (the "Contractor") that the contract between them originally dated as of June 30, 2015, Contract # 29018, as amended to date, (the "Contract") is hereby amended as follows:

I. Contract Term. The Contract end date, wherever such reference appears in the Contract, shall be changed from June 20, 2022 to June 30, 2022.

Taxes Due to the State. Contractor certifies under the pains and penalties of perjury that, as of the date this contract amendment is signed, the Contractor is in good standing with respect to, or in full compliance with a plan to pay, any and all taxes due the State of Vermont.

Child Support (Applicable to natural persons only; not applicable to corporations, partnerships or LLCs). Contractor is under no obligation to pay child support or is in good standing with respect to or in full compliance with a plan to pay any and all child support payable under a support order as of the date of this amendment.

Certification Regarding Suspension or Debarment. Contractor certifies under the pains and penalties of perjury that, as of the date this contract amendment is signed, neither Contractor nor Contractor's principals

CONTRACT**State of Vermont**

Buildings and General Services
Office of Purchasing & Contracting
109 State St
Montpelier VT 05609-3001
USA



Supplier 0000010383
Valk Manufacturing Co
PO Box 428
New Kingstown PA 17072-0428
USA

Contract ID 000000000000000000029018	Page 8 of 8
Contract Dates 06/30/2015 to 03/31/2024	Origin CPS
Description: SNOWPLOW BLADE CUTTING EDGES	Contract Maximum \$9,999,990.00
Buyer Name William A Vivian Jr.	Buyer Phone 828-4681
Contract Status Approved	

Phone #: 717-766-0711

Line #	Item ID	Item Desc	UOM	Unit Price	Max Qty	Max Amt
--------	---------	-----------	-----	------------	---------	---------

WE THE UNDERSIGNED PARTIES AGREE TO BE BOUND BY THIS CONTRACT

By the STATE of VERMONT

Date: _____ DocuSigned by: 12/21/2023
Signature: Jennifer M. V. Fitch
Name: Jennifer M.V. Fitch

Title: Commissioner - Buildings and General Services
Email: _____

By the CONTRACTOR

Date: 12/20/23
Signature: Dan C. Cribari
Name: Dan C. Cribari

Title: Sales Manager, Snow Plow Division
Email: plowsales@valkmfg.com

STATE OF NEBRASKA CONTRACT AMENDMENT

State Purchasing Bureau
1526 K Street, Suite 130
Lincoln, Nebraska 68508

Telephone: (402) 471-6500
Fax: (402) 471-2089

CONTRACT NUMBER
15161 OC

PAGE 1 of 1	ORDER DATE 07/13/23
BUSINESS UNIT 9000	BUYER JOSHUA RIEKENBERG (AS)
VENDOR NUMBER: 553151	
VENDOR ADDRESS: VALK MANUFACTURING COMPANY PO BOX 428 NEW KINGSTOWN PA 17072-0428	

THE CONTRACT PERIOD IS:

JUNE 30, 2023 THROUGH DECEMBER 31, 2023

THIS CONTRACT HAS BEEN AMENDED PER THE FOLLOWING INFORMATION:

NO ACTION ON THE PART OF THE CONTRACTOR NEEDS TO BE TAKEN AT THIS TIME. ORDERS FOR THE MATERIALS AND/OR SERVICES WILL BE MADE AS NEEDED BY THE VARIOUS AGENCIES OF THE STATE.

THIS CONTRACT IS NOT AN EXCLUSIVE CONTRACT TO FURNISH THE MATERIALS AND/OR SERVICES SHOWN BELOW, AND DOES NOT PRECLUDE THE PURCHASE OF SIMILAR MATERIALS AND/OR SERVICES FROM OTHER SOURCES.

THE STATE RESERVES THE RIGHT TO EXTEND THE PERIOD OF THIS CONTRACT BEYOND THE TERMINATION DATE WHEN MUTUALLY AGREEABLE TO THE CONTRACTOR AND THE STATE OF NEBRASKA.

15161 OC Valk Manufacturing Company verbiage
Awarded from NASPO Master Agreement No. 29018
Contract to supply and deliver Snow plow Blade cutting Edges to State of Nebraska agencies for the period of June 30, 2023 through December 31, 2023.

Payment Terms: Net 45

For the File: This RFP and Contract are bid and awarded by the State of Vermont, on behalf of NASPO ValuePoint. All backup bids, etc are retained by the State of Vermont, Buildings and General Services, Office of Purchasing and Contracting. The NASPO ValuePoint/Snowplow Blade cutting Edges Master Agreement became effective June 30, 2015.

Vendor Contact: Dan Cribari
Phone: (717) 766-0711 ext 122
Fax: 717-697-6297
plowsales@valkmfg.com

Amendment Five (5) as attached. (AM 07/13/23)

Line	Description	Estimated Quantity	Unit of Measure	Unit Price
1	SNOWPLOW BLADES & ACCESSORIES	1,000,000.0000	\$	1.0000

DS
RT
8/24/2023

DocuSigned by:
Joshua Riekenberg
8/24/2023
AA890823E56145E... BUYER

DocuSigned by:
Amara Block
8/24/2023
4CFF2711162A4A2... MATERIAL ADMINISTRATOR

**PARTICIPATING ADDENDUM
NASPO VALUEPOINT
AMENDMENT FIVE (5)
(Hereinafter “Amendment”)**

Administered by the State of Vermont (hereinafter “Lead State”)

**MASTER AGREEMENT
Amendment Eight (8)**

**Valk Manufacturing Company.
Master Agreement Number #29018
(Hereinafter “Contractor”)**

and

**State of Nebraska Contract 15161 OC
(Hereinafter “Participating State/Entity”)**

THIS AMENDMENT is by and between the State of Nebraska (“Participating State/Entity”) and Valk Manufacturing Company. (Contractor).

WHEREAS, the Lead State (Vermont) has a Contract with the Contractor identified as Master Agreement Number #29018 to provide Snowplow Blade Cutting Edges for use by State Agencies and other entities. The State has entered into a Participating Addendum/Contract with the Contractor, identified as 15161 OC.

WHEREAS, the terms of the Contract specifically state that the Contract may be amended per agreement by both parties. The State of Nebraska wishes to continue to take advantage of existing contract.

NOW, THEREFORE, it is agreed by the parties to amend the Contract as follows:

Effective July 1, 2023:

1. **CHANGES:** The purpose of this Amendment Five (5) is as follows:

- a. The Contract end date, wherever such reference appears in the Contract, shall be changed from June 30, 2023, to December 31, 2023.

**PARTICIPATING ADDENDUM
 NASPO VALUEPOINT
 AMENDMENT FIVE (5)
 (Hereinafter "Amendment")**

Administered by the State of Vermont (hereinafter "Lead State")

**MASTER AGREEMENT
 Amendment Eight (8)**

**Valk Manufacturing Company.
 Master Agreement Number #29018
 (Hereinafter "Contractor")**

and

**State of Nebraska Contract 15161 OC
 (Hereinafter "Participating State/Entity")**

Terms and Conditions inconsistent with, contrary, or in addition to the Terms and Conditions of this Participating Addendum Amendment and the Price Agreement, together with its exhibits, shall not be added to or incorporated into this Participating Addendum Amendment or the Price Agreement and its exhibits, by any subsequent purchase order or otherwise. Any such attempts to add or incorporate such Terms and Conditions are hereby rejected. The Terms and Conditions of this Participating Addendum Amendment, the Price Agreement, and its exhibits, shall prevail and govern in the case of any such inconsistent or additional terms. This Participating Addendum Amendment applies only in the jurisdiction of the Participating State or Participating Entity, which has executed this Participating Addendum Amendment.

IN WITNESS WHEREOF, the parties have executed this Participating Addendum Amendment as of the date of execution by both parties:

Participating State: Nebraska	Contractor: Valk Manufacturing Company
Signature:  <small>DocuSigned by: Amara Block 4CFF2711162A4A2...</small>	Signature:  <small>DocuSigned by: Dan Cribari F4CEF1078FD0452...</small>
Printed Name: Amara Block	Printed Name: Dan Cribari
Title: Chief Procurement Officer	Title: Sales Manager, Snow Plow Division
Date: 8/24/2023	Date: 7/13/2023

State of Vermont

Buildings and General Services
Office of Purchasing & Contracting
109 State St
Montpelier VT 05609-3001
USA

CONTRACT



Supplier 0000010383
Valk Manufacturing Co
PO Box 428
New Kingstown PA 17072-0428
USA

Contract ID 0000000000000000000029018	Page 1 of 7	
Contract Dates 06/30/2015 to 12/31/2023	Origin CPS	
Description: SNOWPLOW BLADE CUTTING EDGES	Contract Maximum \$9,999,990.00	
Buyer Name William A Vivian Jr.	Buyer Phone 828-4681	Contract Status Approved

Phone #: 717-766-0711

Line #	Item ID	Item Desc	UOM	Unit Price	Max Qty	Max Amt
1		SNOWPLOW BLADE CUTTING EDGES. CONTACT CONTRACTOR FOR PRICE QUOTE	EA	0.01000	0.00	0.00

BLADES PER THE ATTACHED LIST

STANDARD CONTRACT FOR SNOWPLOWBLADE CUTTING EDGES

1. Parties. This is a contract for services between the State of Vermont, Office of Purchasing and Contracting (hereafter called "State"), and Valk Manufacturing, with the principal place of business in New Kingstown, PA 07072, (hereafter called "Contractor"). Contractor's form of business organization is Corporation. It is the contractor's responsibility to contact the Vermont Department of Taxes to determine if, by law, the contractor is required to have a Vermont Department of Taxes Business Account Number.

2. Subject Matter. The subject matter of this contract is services generally on the subject of Snowplow Blade Cutting Edges.

3. Contract Term. The period of contractor's performance shall begin on June 30, 2015 and end on June 30, 2017, with option to renew for five (5) one year periods.

If the state exercises the option, it will provide written notice to contractor prior to the end of the term. If exercised, the provision of the option letter shall become part of and be incorporated into the original master price agreement. The total duration of this master price agreement, including the exercise of any options, shall not exceed five years.

4. Prior Approvals. If approval by the Attorney General's Office or the Secretary of Administration is required, (under current law, bulletins, and interpretations), neither this contract nor any amendment to it is binding until it has been approved by either or both such persons.

- Approval by the Attorney General's Office is required.
- Approval by the Secretary of Administration is required.
- Approval by the CIO/Commissioner DII is not required.

5. Amendment. This agreement represents the entire agreement between the parties; No changes, modifications, or amendments in the terms and conditions of this contract shall be effective unless reduced to writing, numbered and signed by the duly authorized representative of the State and Contractor.

6. Cancellation. This contract may be canceled by either party by giving written notice at least thirty (30) days in advance.

7. Attachments. This contract consists of 160 pages including the following attachments which are incorporated herein:

- Attachment A - Master Agreement Terms and Conditions
- Attachment B - Payment Provisions
- Attachment B1-Price Schedule
- Attachment C - "Standard State Provisions for Contracts and Grants" a preprinted form (revision date March 1, 2015).
- Attachment D - Snowplow Blade Cutting Edges Detailed Specifications

8. Order of Precedence. Any ambiguity, conflict or inconsistency in the Contract Documents shall be resolved according to the following order of precedence:

- (1) Standard Contract
- (2) Attachment C (Standard Contract Provisions for Contracts and Grants)
- (3) Attachment A
- (4) Attachment D

State of Vermont

Buildings and General Services
Office of Purchasing & Contracting
109 State St
Montpelier VT 05609-3001
USA

CONTRACT



Supplier 0000010383
Valk Manufacturing Co
PO Box 428
New Kingstown PA 17072-0428
USA

Contract ID 0000000000000000000029018	Page 2 of 7
Contract Dates 06/30/2015 to 12/31/2023	Origin CPS
Description: SNOWPLOW BLADE CUTTING EDGES	Contract Maximum \$9,999,990.00
Buyer Name William A Vivian Jr.	Buyer Phone 828-4681
Contract Status Approved	

Phone #: 717-766-0711

Line #	Item ID	Item Desc	UOM	Unit Price	Max Qty	Max Amt
--------	---------	-----------	-----	------------	---------	---------

- (5) Attachment B
- (6) Attachment B1

CONTRACTOR POC:

Dan Cribari
Sales Manager, Snow Plow Division
Valk Manufacturing Company
plowsales@valkmfg.com
Phone: (717) 766-0711 ext. 122
Fax: (717) 697-6297

QUANTITY: THE ANNUAL VALUE AND QUANTITIES ARE ESTIMATED ONLY BASED ON PRIOR USAGE; ACTUAL PURCHASES MAY BE HIGHER OR LOWER DEPENDING ON THE STATE'S NEEDS. THE CONTRACT MAXIMUM IS NOT REFLECTIVE OF ACTUAL USAGE.

DELIVERY: RESPONSIBILITY FOR PRODUCT DELIVERY REMAINS WITH THE CONTRACTOR UNTIL THE PRODUCT IS PROPERLY DELIVERED AND SIGNED FOR IN ACCORDANCE WITH THE OFFICE OF PURCHASING & CONTRACTING TERMS AND CONDITIONS. SHIPMENTS SHALL BE SECURELY AND PROPERLY PACKED, ACCORDING TO ACCEPTED COMMERCIAL PRACTICES, WITHOUT EXTRA CHARGE FOR PACKING CASES OR OTHER CONTAINERS. SUCH CONTAINERS WILL REMAIN THE PROPERTY OF THE STATE UNLESS OTHERWISE STATED. DELIVERED GOODS THAT DO NOT CONFORM TO THE SPECIFICATIONS OR ARE NOT IN GOOD CONDITION UPON RECEIPT SHALL BE REPLACED PROMPTLY BY THE CONTRACTOR.

PRICING: ALL EQUIPMENT PRICING IS TO INCLUDE F.O.B. DELIVERY TO THE ORDERING FACILITY. NO REQUEST FOR EXTRA DELIVERY COST WILL BE HONORED. ALL EQUIPMENT SHALL BE DELIVERED ASSEMBLED, SERVICED, OILED, AND READY FOR IMMEDIATE USE, UNLESS OTHERWISE REQUESTED BY THE PURCHASING AGENCY.

QUALITY: ALL PRODUCTS PROVIDED UNDER THESE AGREEMENTS WILL BE NEW AND UNUSED, UNLESS OTHERWISE STATED. FACTORY SECONDS OR REMANUFACTURED PRODUCTS WILL NOT BE ACCEPTED UNLESS SPECIFICALLY REQUESTED BY THE PURCHASING AGENCY. ALL PRODUCTS PROVIDED BY THE CONTRACTOR MUST MEET ALL FEDERAL, STATE, AND LOCAL STANDARDS FOR QUALITY AND SAFETY REQUIREMENTS. PRODUCTS NOT MEETING THESE STANDARDS WILL BE DEEMED UNACCEPTABLE AND RETURNED TO THE CONTRACTOR FOR CREDIT AT NO CHARGE TO THE STATE.

METHOD OF ORDERING: PURCHASE ORDERS MUST BE USED TO ORDER ITEMS AVAILABLE UNDER THIS CONTRACT. IF VERBAL ORDERS ARE GIVEN A CONFIRMING PURCHASE ORDER MUST BE ISSUED.

INVOICING: ALL INVOICES ARE TO BE RENDERED BY THE CONTRACTOR ON THE VENDOR'S STANDARD BILLHEAD AND FORWARDED DIRECTLY TO THE INSTITUTION OR AGENCY ORDERING MATERIALS OR SERVICES AND SHALL SPECIFY THE ADDRESS TO WHICH PAYMENTS WILL BE SENT.

CANCELLATION: THE STATE SPECIFICALLY RESERVES THE RIGHT TO CANCEL THE CONTRACT, OR ANY PORTION THEREOF, IF, IN THE OPINION OF ITS COMMISSIONER OF BUILDINGS AND GENERAL SERVICES, THE SERVICES OR MATERIALS SUPPLIED BY THE CONTRACTOR ARE NOT SATISFACTORY OR ARE NOT CONSISTENT WITH THE TERMS OF THE CONTRACT

DEFAULT: IN CASE OF DEFAULT OF THE CONTRACTOR, THE STATE MAY PROCURE THE MATERIALS OR SUPPLIES FROM OTHER SOURCES AND HOLD THE CONTRACTOR RESPONSIBLE FOR ANY EXCESS COST OCCASIONED THEREBY, PROVIDED, THAT IF PUBLIC NECESSITY REQUIRES THE USE OF MATERIALS OR SUPPLIES NOT CONFORMING TO THE SPECIFICATIONS THEY MAY BE ACCEPTED AND PAYMENT THEREFORE SHALL BE MADE AT A PROPER REDUCTION IN PRICE.

CONTRACT TERMS: THIS CONTRACT WILL BE SUBJECT TO REVIEW THROUGHOUT ITS TERM. THE STATE WILL CONSIDER CANCELLATION UPON DISCOVERY THAT A VENDOR IS IN VIOLATION OF ANY PORTION OF THE AGREEMENT, INCLUDING AN INABILITY BY THE VENDOR TO PROVIDE THE PRODUCTS, SUPPORT, AND/OR SERVICE OFFERED IN THEIR RESPONSE.

VERMONT STATE COLLEGES: THIS CONTRACT IS ALSO AVAILABLE FOR USE BY THE UNIVERSITY OF VERMONT AND THE VERMONT STATE COLLEGES INC., A SEPARATE CORPORATION, HAVING UNDER ITS JURISDICTION CASTLETON STATE COLLEGE, JOHNSON STATE COLLEGE, LYNDON STATE COLLEGE, COMMUNITY COLLEGE OF VERMONT, AND THE VERMONT TECHNICAL COLLEGE.

TOWNS AND SCHOOLS OF THE STATE OF VERMONT: AT THE BIDDER'S ELECTION POLITICAL SUBDIVISIONS AND INDEPENDENT COLLEGES OF THE STATE MAY PARTICIPATE IN STATE CONTRACTS AT THE SAME PRICES, TERMS AND CONDITIONS. ITEMS FURNISHED TO POLITICAL SUBDIVISIONS AND INDEPENDENT COLLEGES WILL BE BILLED DIRECTLY TO AND PAID FOR BY THE POLITICAL SUBDIVISIONS OR INDEPENDENT COLLEGES AND NEITHER THE STATE NOR ITS COMMISSIONER OF BUILDINGS AND GENERAL SERVICES PERSONALLY OR OFFICIALLY ASSUMES ANY RESPONSIBILITY FOR THESE PAYMENTS.

State of Vermont

Buildings and General Services
Office of Purchasing & Contracting
109 State St
Montpelier VT 05609-3001
USA

CONTRACT



Supplier 0000010383
Valk Manufacturing Co
PO Box 428
New Kingstown PA 17072-0428
USA

Contract ID 0000000000000000000029018	Page 3 of 7
Contract Dates 06/30/2015 to 12/31/2023	Origin CPS
Description: SNOWPLOW BLADE CUTTING EDGES	Contract Maximum \$9,999,990.00
Buyer Name William A Vivian Jr.	Buyer Phone 828-4681
Contract Status Approved	

Phone #: 717-766-0711

Line #	Item ID	Item Desc	UOM	Unit Price	Max Qty	Max Amt
--------	---------	-----------	-----	------------	---------	---------

AGENCIES & DEPARTMENTS ARE REQUESTED TO ADVISE THE PURCHASING AGENT AT ONCE OF THE FAILURE ON THE PART OF THE CONTRACTOR TO FULFILL ANY OF THE TERMS OR CONDITIONS OF THIS CONTRACT.

PLEASE REFER TO THE ASSIGNED CONTRACT NUMBER/PURCHASE ORDER # ON ALL CORRESPONDENCE, DELIVERY DOCUMENTS AND INVOICES.

APRIL 7, 2017
AMENDMENT #01 - TO EXTEND CONTRACT FOR A ONE YEAR PERIOD AT THE SAME PRICES, TERMS AND CONDITIONS.

JUNE 7, 2018
AMENDMENT #02 - TO EXTEND CONTRACT FOR A ONE YEAR PERIOD AT THE SAME PRICES, TERMS AND CONDITIONS WITH THE FOLLOWING EXCEPTIONS:

1). PRICING: DUE TO TARIFFS ON IMPORTED STEEL CURRENTLY IN EFFECT, PLOW BLADE PRICING IS HEREBY REMOVED FROM THE ATTACHED PRODUCT LIST. ORDERING ENTITIES ARE TO REQUEST A QUOTE FROM CONTRACTOR FOR PRICING IN EFFECT AT TIME OF ORDER.

ATTACHMENT C: STANDARD STATE PROVISIONS FOR CONTRACTS AND GRANTS REVISED DECEMBER 15, 2017 IS INCORPORATED INTO THE CONTRACT.

CONTRACTOR CERTIFIES UNDER THE PAINS AND PENALTIES OF PERJURY THAT, AS OF THE DATE THIS CONTRACT AMENDMENT IS SIGNED, CONTRACTOR IS IN GOOD STANDING WITH RESPECT TO, OR IN FULL COMPLIANCE WITH A PLAN TO PAY ANY AND ALL TAXES DUE THE STATE OF VERMONT.

CERTIFICATION REGARDING SUSPENSION OR DEBARMENT. CONTRACTOR CERTIFIES UNDER THE PAINS AND PENALTIES OF PERJURY THAT, AS OF THIS DATE THIS CONTRACT AMENDMENT IS SIGNED, NEITHER PARTY NO PARTY'S PRINCIPALS (OFFICERS, DIRECTORS, OWNERS, OR PARTNERS) ARE PRESENTLY DEBARRED, SUSPENDED, PROPOSED FOR DEBARMENT, DECLARED INELIGIBLE OR EXCLUDED FROM PARTICIPATION IN FEDERAL PROGRAMS, OR PROGRAMS SUPPORTED IN WHOLE OR IN PART BY FEDERAL FUNDS.

PARTY FURTHER CERTIFIES UNDER PAINS AND PENALTIES OF PERJURY THAT, AS OF THE DATE THIS AGREEMENT IS SIGNED, PARTY IS NOT PRESENTLY DEBARRED, SUSPENDED, NOR NAMED ON THE STATE'S DEBARMENT LIST AT: [HTTP://BGS.VERMONT.GOV/PURCHASING/DEBARMENT](http://BGS.VERMONT.GOV/PURCHASING/DEBARMENT).

CHILD SUPPORT (APPLICABLE TO NATURAL PERSONS ONLY; NOT APPLICABLE TO CORPORATIONS, PARTNERSHIPS OR LLCs): CONTRACTOR IS UNDER NO OBLIGATION TO PAY CHILD SUPPORT OR IS IN GOOD STANDING WITH RESPECT TO OR IN FULL COMPLIANCE WITH A PLAN TO PAY ANY AND ALL CHILD SUPPORT PAYABLE UNDER A SUPPORT ORDER AS OF THE DATE OF THIS AMENDMENT.

AMENDMENT#3 (MAY 2019). THIS CHANGE ORDER EXERCISES THE THIRD OF THE FIVE ONE-YEAR OPTIONS TO RENEW, AND EXTENDS THE CONTRACT FOR ONE ADDITIONAL YEAR TO 06/30/2020, AT THE SAME PRICING, TERMS, AND CONDITIONS.

STATE OF VERMONT ATTACHMENT C: STANDARD STATE CONTRACT PROVISIONS DATED DECEMBER 15, 2017 IS ATTACHED AND INCORPORATED AS PART OF THIS ORDER.

CONTRACTOR CERTIFIES UNDER THE PAINS AND PENALTIES OF PERJURY THAT AS OF THE DATE THIS AMENDMENT IS SIGNED, CONTRACT IS IN GOOD STANDING TO OR IN FULL COMPLIANCE WITH A PLAN TO PAY ANY AND ALL TAXES DUE THE STATE OF VERMONT.

CERTIFICATION REGARDING SUSPENSION OR DISBARMENT. CONTRACTOR CERTIFIES UNDER THE PAINS AND PENALTIES OF PERJURY THAT, AS OF THIS DATE THIS CONTRACT AMENDMENT IS SIGNED, NEITHER PARTY NO PARTY'S PRINCIPALS (OFFICERS, DIRECTORS, OWNERS, OR PARTNERS) ARE PRESENTLY DEBARRED, SUSPENDED, PROPOSED FOR DEBARMENT, DECLARED INELIGIBLE OR EXCLUDED FROM PARTICIPATION IN FEDERAL PROGRAMS, OR PROGRAMS SUPPORTED IN WHOLE OR IN PART BY FEDERAL FUNDS.

State of Vermont

Buildings and General Services
Office of Purchasing & Contracting
109 State St
Montpelier VT 05609-3001
USA

CONTRACT



Supplier 0000010383
Valk Manufacturing Co
PO Box 428
New Kingstown PA 17072-0428
USA

Contract ID 000000000000000000029018	Page 4 of 7
Contract Dates 06/30/2015 to 12/31/2023	Origin CPS
Description: SNOWPLOW BLADE CUTTING EDGES	Contract Maximum \$9,999,990.00
Buyer Name William A Vivian Jr.	Buyer Phone 828-4681
Contract Status Approved	

Phone #: 717-766-0711

Line #	Item ID	Item Desc	UOM	Unit Price	Max Qty	Max Amt
--------	---------	-----------	-----	------------	---------	---------

CHILD SUPPORT (APPLICABLE TO NATURAL PERSONS ONLY; NOT APPLICABLE TO CORPORATIONS, PARTNERSHIPS OR LLCs):

CONTRACTOR IS UNDER NO OBLIGATION TO PAY CHILD SUPPORT OR IS IN GOOD STANDING WITH RESPECT TO OR IN FULL COMPLIANCE WITH A PLAN TO PAY ANY AND ALL CHILD SUPPORT PAYABLE UNDER A SUPPORT ORDER AS OF THE DATE OF THIS AMENDMENT.

PARTY FURTHER CERTIFIES UNDER PAINS AND PENALTIES OF PERJURY THAT, AS OF THE DATE THIS AGREEMENT IS SIGNED, PARTY IS NOT PRESENTLY DEBARRED, SUSPENDED, NOR NAMED ON THE STATE'S DEBARMENT LIST AT: [HTTP://BGS.VERMONT.GOV/PURCHASING/DEBARMENT](http://BGS.VERMONT.GOV/PURCHASING/DEBARMENT).

STATE OF VERMONT
CONTRACT AMENDMENT #4

It is hereby agreed by and between the State of Vermont, Office of Purchasing and Contracting (the "State") and Valk Manufacturing Company Inc. , with a principal place of business in New Kingstown, PA (the "Contractor") that the contract between them originally dated as of June 30, 2015, Contract # 29018, as amended to date, (the "Contract") is hereby amended as follows:

II. Contract Term. The Contract end date, wherever such reference appears in the Contract, shall be changed from June 30, 2020 to June 30, 2021. The Contract Term may be renewed for one additional one-year period at the discretion of the State.

Taxes Due to the State. Contractor certifies under the pains and penalties of perjury that, as of the date this contract amendment is signed, the Contractor is in good standing with respect to, or in full compliance with a plan to pay, any and all taxes due the State of Vermont.

Child Support (Applicable to natural persons only; not applicable to corporations, partnerships or LLCs). Contractor is under no obligation to pay child support or is in good standing with respect to or in full compliance with a plan to pay any and all child support payable under a support order as of the date of this amendment.

Certification Regarding Suspension or Debarment. Contractor certifies under the pains and penalties of perjury that, as of the date this contract amendment is signed, neither Contractor nor Contractor's principals (officers, directors, owners, or partners) are presently debarred, suspended, proposed for debarment, declared ineligible or excluded from participation in federal programs, or programs supported in whole or in part by federal funds.

Contractor further certifies under pains and penalties of perjury that, as of the date this contract amendment is signed, Contractor is not presently debarred, suspended, nor named on the State's debarment list at: <http://bgs.vermont.gov/purchasing-contracting/debarment>

This document consists of 5 pages. Except as modified by this Amendment No. 4, all provisions of the Contract remain in full force and effect.

STATE OF VERMONT CONTACT:
BILL VIVIAN
PURCHASING AGENT
802-828-4681
FAX 802-828-2222
BILL.VIVIAN@Vermont.gov

STATE OF VERMONT June 2021
CONTRACT AMENDMENT 5

It is hereby agreed by and between the State of Vermont, Office of Purchasing and Contracting (the "State") and Valk Manufacturing Co, with a principal place of business in New Kingstown, PA (the "Contractor") that the

State of Vermont

Buildings and General Services
Office of Purchasing & Contracting
109 State St
Montpelier VT 05609-3001
USA

CONTRACT



Supplier 0000010383
Valk Manufacturing Co
PO Box 428
New Kingstown PA 17072-0428
USA

Contract ID 0000000000000000000029018	Page 5 of 7
Contract Dates 06/30/2015 to 12/31/2023	Origin CPS
Description: SNOWPLOW BLADE CUTTING EDGES	Contract Maximum \$9,999,990.00
Buyer Name William A Vivian Jr.	Buyer Phone 828-4681
Contract Status Approved	

Phone #: 717-766-0711

Line #	Item ID	Item Desc	UOM	Unit Price	Max Qty	Max Amt
--------	---------	-----------	-----	------------	---------	---------

contract between them originally dated as of June 30, 2015, Contract # 29018, as amended to date, (the "Contract") is hereby amended as follows:

I. Contract Term. The Contract end date, wherever such reference appears in the Contract, shall be changed from June 30, 2021 to June 20, 2022.

Taxes Due to the State. Contractor certifies under the pains and penalties of perjury that, as of the date this contract amendment is signed, the Contractor is in good standing with respect to, or in full compliance with a plan to pay, any and all taxes due the State of Vermont.

Child Support (Applicable to natural persons only; not applicable to corporations, partnerships or LLCs). Contractor is under no obligation to pay child support or is in good standing with respect to or in full compliance with a plan to pay any and all child support payable under a support order as of the date of this amendment.

Certification Regarding Suspension or Debarment. Contractor certifies under the pains and penalties of perjury that, as of the date this contract amendment is signed, neither Contractor nor Contractor's principals (officers, directors, owners, or partners) are presently debarred, suspended, proposed for debarment, declared ineligible or excluded from participation in federal programs, or programs supported in whole or in part by federal funds.

Contractor further certifies under pains and penalties of perjury that, as of the date this contract amendment is signed, Contractor is not presently debarred, suspended, nor named on the State's debarment list at: <http://bgs.vermont.gov/purchasing-contracting/debarment>

Sole Source Contract for Services. This Contract results from a "sole source" procurement under State of Vermont Administrative Bulletin 3.5 process and Contractor hereby certifies that it is and will remain in compliance with the campaign contribution restrictions under 17 V.S.A. § 2950.

SOV Cybersecurity Standard 19-01. All products and service provided to or for the use of the State under this Contract shall be in compliance with State of Vermont Cybersecurity Standard 19-01, which Contractor acknowledges has been provided to it, and is available on-line at the following URL:<https://digitalservices.vermont.gov/cybersecurity/cybersecurity-standards-and-directives>

This document consists of 6 pages. Except as modified by this Amendment No. 5, all provisions of the Contract remain in full force and effect.

STATE OF VERMONT July 2021
CONTRACT AMENDMENT 6

It is hereby agreed by and between the State of Vermont, Office of Purchasing and Contracting (the "State") and Valk Manufacturing Co, with a principal place of business in New Kingstown, PA (the "Contractor") that the contract between them originally dated as of June 30, 2015, Contract # 29018, as amended to date, (the "Contract") is hereby amended as follows:

I. Contract Term. The Contract end date, wherever such reference appears in the Contract, shall be changed from June 20, 2022 to June 30, 2022.

Taxes Due to the State. Contractor certifies under the pains and penalties of perjury that, as of the date this contract amendment is signed, the Contractor is in good standing with respect to, or in full compliance with a plan to pay, any and all taxes due the State of Vermont.

Child Support (Applicable to natural persons only; not applicable to corporations, partnerships or LLCs). Contractor is under no obligation to pay child support or is in good standing with respect to or in full compliance with a plan to pay any and all child support payable under a support order as of the date of this amendment.

Certification Regarding Suspension or Debarment. Contractor certifies under the pains and penalties of perjury that, as of the date this contract amendment is signed, neither Contractor nor Contractor's principals

State of Vermont

Buildings and General Services
Office of Purchasing & Contracting
109 State St
Montpelier VT 05609-3001
USA

CONTRACT



Supplier 0000010383
Valk Manufacturing Co
PO Box 428
New Kingstown PA 17072-0428
USA

Table with contract details: Contract ID (0000000000000000000029018), Contract Dates (06/30/2015 to 12/31/2023), Description (SNOWPLOW BLADE CUTTING EDGES), Buyer Name (William A Vivian Jr.), Buyer Phone (828-4681), Contract Status (Approved), Origin (CPS), Contract Maximum (\$9,999,990.00), Page (6 of 7)

Phone #: 717-766-0711

Table header with columns: Line #, Item ID, Item Desc, UOM, Unit Price, Max Qty, Max Amt

(officers, directors, owners, or partners) are presently debarred, suspended, proposed for debarment, declared ineligible or excluded from participation in federal programs, or programs supported in whole or in part by federal funds.

Contractor further certifies under pains and penalties of perjury that, as of the date this contract amendment is signed, Contractor is not presently debarred, suspended, nor named on the State's debarment list at: http://bgs.vermont.gov/purchasing-contracting/debarment

Sole Source Contract for Services. This Contract results from a "sole source" procurement under State of Vermont Administrative Bulletin 3.5 process and Contractor hereby certifies that it is and will remain in compliance with the campaign contribution restrictions under 17 V.S.A. § 2950.

SOV Cybersecurity Standard 19-01. All products and service provided to or for the use of the State under this Contract shall be in compliance with State of Vermont Cybersecurity Standard 19-01, which Contractor acknowledges has been provided to it, and is available on-line at the following URL:https://digitalservices.vermont.gov/cybersecurity/cybersecurity-standards-and-directives

This document consists of 7 pages. Except as modified by this Amendment No. 6, all provisions of the Contract remain in full force and effect.

CONTRACT AMENDMENT #7
May 2022

It is hereby agreed by and between the State of Vermont, Office of Purchasing and Contracting (the "State") and Valk Manufacturing Co, with a principal place of business in New Kingstown, PA (the "Contractor") that the contract between them originally dated as of June 30, 2015, Contract # 29018, as amended to date, (the "Contract") is hereby amended as follows:

I. Contract Term. The Contract end date, wherever such reference appears in the Contract, shall be changed from June 30, 2022 to June 30, 2023.

Taxes Due to the State. Contractor certifies under the pains and penalties of perjury that, as of the date this contract amendment is signed, the Contractor is in good standing with respect to, or in full compliance with a plan to pay, any and all taxes due the State of Vermont.

Child Support (Applicable to natural persons only; not applicable to corporations, partnerships or LLCs). Contractor is under no obligation to pay child support or is in good standing with respect to or in full compliance with a plan to pay any and all child support payable under a support order as of the date of this amendment.

Certification Regarding Suspension or Debarment. Contractor certifies under the pains and penalties of perjury that, as of the date this contract amendment is signed, neither Contractor nor Contractor's principals (officers, directors, owners, or partners) are presently debarred, suspended, proposed for debarment, declared ineligible or excluded from participation in federal programs, or programs supported in whole or in part by federal funds.

Contractor further certifies under pains and penalties of perjury that, as of the date this contract amendment is signed, Contractor is not presently debarred, suspended, nor named on the State's debarment list at: http://bgs.vermont.gov/purchasing-contracting/debarment

This document consists of 7 pages. Except as modified by this Amendment No. 7, all provisions of the Contract remain in full force and effect.

CONTRACT AMENDMENT #8
March 2023

It is hereby agreed by and between the State of Vermont, Office of Purchasing and Contracting (the "State") and Valk Manufacturing Co, with a principal place of business in New Kingstown, PA (the "Contractor") that the contract between them originally dated as of June 30, 2015, Contract # 29018, as amended to date, (the "Contract") is hereby amended as follows:

State of Vermont

Buildings and General Services
Office of Purchasing & Contracting
109 State St
Montpelier VT 05609-3001
USA

CONTRACT

Supplier 0000010383
Valk Manufacturing Co
PO Box 428
New Kingstown PA 17072-0428
USA

Contract ID 000000000000000000029018	Page 7 of 7
Contract Dates 06/30/2015 to 12/31/2023	Origin CPS
Description: SNOWPLOW BLADE CUTTING EDGES	Contract Maximum \$9,999,990.00
Buyer Name William A Vivian Jr.	Buyer Phone 828-4681
Contract Status Approved	

Phone #: 717-766-0711

Line #	Item ID	Item Desc	UOM	Unit Price	Max Qty	Max Amt
--------	---------	-----------	-----	------------	---------	---------

I. Contract Term. The Contract end date, wherever such reference appears in the Contract, shall be changed from June 30, 2023 to December 31, 2023.

Taxes Due to the State. Contractor certifies under the pains and penalties of perjury that, as of the date this contract amendment is signed, the Contractor is in good standing with respect to, or in full compliance with a plan to pay, any and all taxes due the State of Vermont.

Child Support (Applicable to natural persons only; not applicable to corporations, partnerships or LLCs). Contractor is under no obligation to pay child support or is in good standing with respect to or in full compliance with a plan to pay any and all child support payable under a support order as of the date of this amendment.

Certification Regarding Suspension or Debarment. Contractor certifies under the pains and penalties of perjury that, as of the date this contract amendment is signed, neither Contractor nor Contractor's principals (officers, directors, owners, or partners) are presently debarred, suspended, proposed for debarment, declared ineligible or excluded from participation in federal programs, or programs supported in whole or in part by federal funds.

Contractor further certifies under pains and penalties of perjury that, as of the date this contract amendment is signed, Contractor is not presently debarred, suspended, nor named on the State's debarment list at: <http://bgs.vermont.gov/purchasing-contracting/debarment>

This document consists of 7 pages. Except as modified by this Amendment No. 8, all provisions of the Contract remain in full for

WE THE UNDERSIGNED PARTIES AGREE TO BE BOUND BY THIS CONTRACT

By the STATE of VERMONT

Date: 3/21/2023
Signature: Jennifer M. V. Fitch, BGS Commissioner
Name: Jennifer M. V. Fitch

Title: Commissioner - Buildings and General Services
Email: _____

By the CONTRACTOR

Date: 3/17/23
Signature: Dan C. Cribari
Name: Dan C. Cribari

Title: Sales Manager, Snow Plow Division
Email: plowsales@valkmfg.com

STATE OF NEBRASKA CONTRACT AWARD

State Purchasing Bureau
1526 K Street, Suite 130
Lincoln, Nebraska 68508

Telephone: (402) 471-6500
Fax: (402) 471-2089

CONTRACT NUMBER
15161 OC

PAGE 1 of 1	ORDER DATE 07/09/22
BUSINESS UNIT 9000	BUYER CHRISTIE KELLY (AS)
VENDOR NUMBER: 553151	
VENDOR ADDRESS: VALK MANUFACTURING COMPANY PO BOX 428 NEW KINGSTOWN PA 17072-0428	

AN AWARD HAS BEEN MADE TO THE CONTRACTOR NAMED ABOVE FOR THE FURNISHING OF MATERIALS AND/OR SERVICES AS LISTED BELOW FOR THE PERIOD:

JUNE 30, 2022 THROUGH JUNE 30, 2023

NO ACTION ON THE PART OF THE CONTRACTOR NEEDS TO BE TAKEN AT THIS TIME. ORDERS FOR THE MATERIALS AND/OR SERVICES WILL BE MADE AS NEEDED BY THE VARIOUS AGENCIES OF THE STATE.

THIS CONTRACT IS NOT AN EXCLUSIVE CONTRACT TO FURNISH THE MATERIALS AND/OR SERVICES SHOWN BELOW, AND DOES NOT PRECLUDE THE PURCHASE OF SIMILAR MATERIALS AND/OR SERVICES FROM OTHER SOURCES.

THE STATE RESERVES THE RIGHT TO EXTEND THE PERIOD OF THIS CONTRACT BEYOND THE TERMINATION DATE WHEN MUTUALLY AGREEABLE TO THE CONTRACTOR AND THE STATE OF NEBRASKA.

15161 OC Valk Manufacturing Company verbiage

Awarded from NASPO Master Agreement No. 29018

Contract to supply and deliver Snow plow Blade cutting Edges to State of Nebraska agencies for the period of June 30, 2022 through June 30, 2023.

Payment Terms: Net 45

For the File: This RFP and Contract are bid and awarded by the State of Vermont, on behalf of NASPO ValuePoint. All backup bids, etc are retained by the State of Vermont, Buildings and General Services, Office of Purchasing and Contracting. The NASPO ValuePoint/Snowplow Blade cutting Edges Master Agreement became effective June 30, 2015.

Vendor Contact: Dan Cribari
Phone: (717) 766-0711 ext 122
Fax: 717-697-6297
plowsales@valkmfg.com

This is the first extension the contract as established by Amendment Seven of the Master Agreement 29018. (MH 7/21/22)

Line	Description	Estimated Quantity	Unit of Measure	Unit Price
1	SNOWPLOW BLADES & ACCESSORIES	1,000,000.0000	\$	1.0000

DS
C

7/26/2022

DocuSigned by:
Brenda Sensibaugh 7/26/2022
F8D079AE588F419... BUYER

DocuSigned by:
Amara Block 7/27/2022
4CFF2711102442... MATERIEL ADMINISTRATOR

**PARTICIPATING ADDENDUM
NASPO VALUEPOINT
AMENDMENT FOUR (4)**
(Hereinafter “Amendment”)

Administered by the State of Vermont (hereinafter “Lead State”)

**MASTER AGREEMENT
Amendment Seven (7)**

**Valk Manufacturing Company.
Master Agreement Number #29018**
(Hereinafter “Contractor”)

and

State of Nebraska Contract 15161 OC
(Hereinafter “Participating State/Entity”)

THIS AMENDMENT is by and between the State of Nebraska (“Participating State/Entity”) and Valk Manufacturing Company. (Contractor).

WHEREAS, the Lead State (Vermont) has a Contract with the Contractor identified as Master Agreement Number #29018 to provide Snowplow Blade Cutting Edges for use by State Agencies and other entities. The State has entered into a Participating Addendum/Contract with the Contractor, identified as 15161 OC.

WHEREAS, the terms of the Contract specifically state that the Contract may be amended per agreement by both parties. The State of Nebraska wishes to continue to take advantage of existing contract.

NOW, THEREFORE, it is agreed by the parties to amend the Contract as follows:

Effective June 30, 2022:

1. **CHANGES:** The purpose of this Amendment Four (4) is as follows:
 - a. The Contract end date, wherever such reference appears in the Contract, shall be changed from June 30, 2022, to June 30, 2023.

**PARTICIPATING ADDENDUM
 NASPO VALUEPOINT
 AMENDMENT FOUR (4)
 (Hereinafter "Amendment")**

Administered by the State of Vermont (hereinafter "Lead State")

**MASTER AGREEMENT
 Amendment One (1)**

**Valk Manufacturing Company.
 Master Agreement Number #29018
 (Hereinafter "Contractor")**

and

**State of Nebraska Contract 15161 OC
 (Hereinafter "Participating State/Entity")**

Terms and Conditions inconsistent with, contrary, or in addition to the Terms and Conditions of this Participating Addendum Amendment and the Price Agreement, together with its exhibits, shall not be added to or incorporated into this Participating Addendum Amendment or the Price Agreement and its exhibits, by any subsequent purchase order or otherwise. Any such attempts to add or incorporate such Terms and Conditions are hereby rejected. The Terms and Conditions of this Participating Addendum Amendment, the Price Agreement, and its exhibits, shall prevail and govern in the case of any such inconsistent or additional terms. This Participating Addendum Amendment applies only in the jurisdiction of the Participating State or Participating Entity, which has executed this Participating Addendum Amendment.

IN WITNESS WHEREOF, the parties have executed this Participating Addendum Amendment as of the date of execution by both parties:

Participating State: Nebraska	Contractor: Valk Manufacturing Company
Signature: <small>DocuSigned by:</small> <i>Amara Block</i>	Signature: <small>DocuSigned by:</small> <i>Dan Cribari</i>
<small>F:\CFE\27111\152\142</small> Printed Name: Amara Block	<small>F:\CFE\1078\ED\152</small> Printed Name: 7/21/2022
Title: Chief Procurement Officer	Title: Sales Manager, Snow Plow Division
Date: 7/27/2022	Date: 7/21/2022

STATE OF NEBRASKA CONTRACT AWARD

State Purchasing Bureau
1526 K Street, Suite 130
Lincoln, Nebraska 68508

Telephone: (402) 471-6500
Fax: (402) 471-2089

CONTRACT NUMBER
15161 OC

PAGE 1 of 1	ORDER DATE 06/28/21
BUSINESS UNIT 9000	BUYER CHRISTIE KELLY (AS)
VENDOR NUMBER: 553151	
VENDOR ADDRESS: VALK MANUFACTURING COMPANY PO BOX 428 NEW KINGSTOWN PA 17072-0428	

AN AWARD HAS BEEN MADE TO THE CONTRACTOR NAMED ABOVE FOR THE FURNISHING OF MATERIALS AND/OR SERVICES AS LISTED BELOW FOR THE PERIOD:

JULY 01, 2021 THROUGH JUNE 30, 2022

NO ACTION ON THE PART OF THE CONTRACTOR NEEDS TO BE TAKEN AT THIS TIME. ORDERS FOR THE MATERIALS AND/OR SERVICES WILL BE MADE AS NEEDED BY THE VARIOUS AGENCIES OF THE STATE.

THIS CONTRACT IS NOT AN EXCLUSIVE CONTRACT TO FURNISH THE MATERIALS AND/OR SERVICES SHOWN BELOW, AND DOES NOT PRECLUDE THE PURCHASE OF SIMILAR MATERIALS AND/OR SERVICES FROM OTHER SOURCES.

THE STATE RESERVES THE RIGHT TO EXTEND THE PERIOD OF THIS CONTRACT BEYOND THE TERMINATION DATE WHEN MUTUALLY AGREEABLE TO THE CONTRACTOR AND THE STATE OF NEBRASKA.

15161 OC Valk Manufacturing Company verbiage

Awarded from NASPO Master Agreement No. 29018

Contract to supply and deliver Snow plow Blade cutting Edges to State of Nebraska agencies for the period of July 01, 2021 through June 30, 2022.

Payment Terms: Net 45

For the File: This RFP and Contract are bid and awarded by the State of Vermont, on behalf of NASPO ValuePoint. All backup bids, etc are retained by the State of Vermont, Buildings and General Services, Office of Purchasing and Contracting. The NASPO ValuePoint/Snowplow Blade cutting Edges Master Agreement became effective June 30, 2015.

Vendor Contact: Dan Cribari
Phone: (717) 766-0711 ext 122
Fax: 717-697-6297
plowsales@valkmfg.com

This is the third renewal of the contract as established by Amendment Three of the Master Agreement 29018. (MH 6/28/21)

Line	Description	Estimated Quantity	Unit of Measure	Unit Price
1	SNOWPLOW BLADES & ACCESSORIES	1,000,000.0000	EA	1.0000

DS
7/12/2021
DocuSigned by: *Brenda Sensibaugh* 7/12/2021
F8D079A...
DocuSigned by: *Amara Block* 7/27/2021
4CFF2711162A42...
BUYER
MATERIEL ADMINISTRATOR

PARTICIPATING ADDENDUM
NASPO VALUEPOINT
AMENDMENT THREE (3)
(Hereinafter "Amendment")

Administered by the State of Vermont (hereinafter "Lead State")

MASTER AGREEMENT
Amendment Three

Valk Manufacturing Company
Master Agreement No: 29018
(Hereinafter "Contractor")

and

State of Nebraska Contract 15161 OC
(Hereinafter "Participating State/Entity")

Page 1 of 2

THIS AMENDMENT is by and between the State of Nebraska ("Participating State/Entity") and Valk Manufacturing Company (Contractor).

WHEREAS, the Lead State (Vermont) has a Contract with the Contractor identified Snowplow Cutting Edges Contract Number #29018 to provide Snowplow Cutting Edges for use by State Agencies and other entities. The State has entered into a Participating Addendum with the Contractor, identified as 15161 OC.

WHEREAS, the terms of the Contract specifically state that the Contract may be amended per agreement by both parties. The State of Nebraska wishes to continue to take advantage of existing contract.

NOW, THEREFORE, it is agreed by the parties to amend the Contract as follows:

Effective July 1, 2021:

1. CHANGES: The purpose of this Amendment Three (3) is as follows:

- a. Contract term is extended from July 1, 2021 through June 30, 2022.

PARTICIPATING ADDENDUM
 NASPO VALUEPOINT
 AMENDMENT THREE (3)
 (Hereinafter "Amendment")

Administered by the State of Vermont (hereinafter "Lead State")

MASTER AGREEMENT
 Amendment Three

Valk Manufacturing Company
 Master Agreement No: 29018
 (Hereinafter "Contractor")

and

State of Nebraska Contract 15161 OC
 (Hereinafter "Participating State/Entity")

Page 2 of 2

Terms and Conditions inconsistent with, contrary, or in addition to the Terms and Conditions of this Participating Addendum Amendment and the Price Agreement, together with its exhibits, shall not be added to or incorporated into this Participating Addendum Amendment or the Price Agreement and its exhibits, by any subsequent purchase order or otherwise. Any such attempts to add or incorporate such Terms and Conditions are hereby rejected. The Terms and Conditions of this Participating Addendum Amendment, the Price Agreement and its exhibits, shall prevail and govern in the case of any such inconsistent or additional terms. This Participating Addendum Amendment applies only in the jurisdiction of the Participating State or Participating Entity, which has executed this Participating Addendum Amendment.

IN WITNESS WHEREOF, the parties have executed this Participating Addendum Amendment as of the date of execution by both parties:

Participating State: Nebraska	Contractor: VALK MANUFACTURING COMPANY
Signature: <small>DocuSigned by:</small> <i>Amara Block</i>	Signature: <small>DocuSigned by:</small> <i>Dan Cribari</i>
<small>40F5211163AFA2</small> Printed Name: Amara Block	<small>F4CEFF078FD0452...</small> Printed Name: Dan Cribari
Title: General Counsel, Acting Chief Procurement Officer	Title: Sales Manager, Snow Plow Division
Date: 7/27/2021	Date: 7/11/2021

State of Vermont

Buildings and General Services
Office of Purchasing & Contracting
109 State St
Montpelier VT 05609-3001
USA

CONTRACT



Supplier 0000010383
Valk Manufacturing Co
PO Box 428
New Kingstown PA 17072-0428
USA

Contract ID 0000000000000000000029018	Page 1 of 6
Contract Dates 06/30/2015 to 06/30/2022	Origin CPS
Description: SNOWPLOW BLADE CUTTING EDGES	Contract Maximum \$9,999,990.00
Buyer Name William A Vivian Jr.	Buyer Phone 828-4681
Contract Status Approved	

Phone #: 717-766-0711

Line #	Item ID	Item Desc	UOM	Unit Price	Max Qty	Max Amt
1		SNOWPLOW BLADE CUTTING EDGES. CONTACT CONTRACTOR FOR PRICE QUOTE	EA	0.01000	0.00	0.00

BLADES PER THE ATTACHED LIST

STANDARD CONTRACT FOR SNOWPLOWBLADE CUTTING EDGES

1. Parties. This is a contract for services between the State of Vermont, Office of Purchasing and Contracting (hereafter called "State"), and Valk Manufacturing, with the principal place of business in New Kingstown, PA 07072, (hereafter called "Contractor"). Contractor's form of business organization is Corporation. It is the contractor's responsibility to contact the Vermont Department of Taxes to determine if, by law, the contractor is required to have a Vermont Department of Taxes Business Account Number.

2. Subject Matter. The subject matter of this contract is services generally on the subject of Snowplow Blade Cutting Edges.

3. Contract Term. The period of contractor's performance shall begin on June 30, 2015 and end on June 30, 2017, with option to renew for five (5) one year periods.

If the state exercises the option, it will provide written notice to contractor prior to the end of the term. If exercised, the provision of the option letter shall become part of and be incorporated into the original master price agreement. The total duration of this master price agreement, including the exercise of any options, shall not exceed five years.

4. Prior Approvals. If approval by the Attorney General's Office or the Secretary of Administration is required, (under current law, bulletins, and interpretations), neither this contract nor any amendment to it is binding until it has been approved by either or both such persons.

- Approval by the Attorney General's Office is required.
- Approval by the Secretary of Administration is required.
- Approval by the CIO/Commissioner DII is not required.

5. Amendment. This agreement represents the entire agreement between the parties; No changes, modifications, or amendments in the terms and conditions of this contract shall be effective unless reduced to writing, numbered and signed by the duly authorized representative of the State and Contractor.

6. Cancellation. This contract may be canceled by either party by giving written notice at least thirty (30) days in advance.

7. Attachments. This contract consists of 160 pages including the following attachments which are incorporated herein:

- Attachment A - Master Agreement Terms and Conditions
- Attachment B - Payment Provisions
- Attachment B1-Price Schedule
- Attachment C - "Standard State Provisions for Contracts and Grants" a preprinted form (revision date March 1, 2015).
- Attachment D - Snowplow Blade Cutting Edges Detailed Specifications

8. Order of Precedence. Any ambiguity, conflict or inconsistency in the Contract Documents shall be resolved according to the following order of precedence:

- (1) Standard Contract
- (2) Attachment C (Standard Contract Provisions for Contracts and Grants)
- (3) Attachment A
- (4) Attachment D

State of Vermont

Buildings and General Services
Office of Purchasing & Contracting
109 State St
Montpelier VT 05609-3001
USA

CONTRACT



Supplier 0000010383
Valk Manufacturing Co
PO Box 428
New Kingstown PA 17072-0428
USA

Contract ID 0000000000000000000029018	Page 2 of 6
Contract Dates 06/30/2015 to 06/30/2022	Origin CPS
Description: SNOWPLOW BLADE CUTTING EDGES	Contract Maximum \$9,999,990.00
Buyer Name William A Vivian Jr.	Buyer Phone 828-4681
Contract Status Approved	

Phone #: 717-766-0711

Line #	Item ID	Item Desc	UOM	Unit Price	Max Qty	Max Amt
--------	---------	-----------	-----	------------	---------	---------

- (5) Attachment B
- (6) Attachment B1

CONTRACTOR POC:

Dan Cribari
Sales Manager, Snow Plow Division
Valk Manufacturing Company
plowsales@valkmfg.com
Phone: (717) 766-0711 ext. 122
Fax: (717) 697-6297

QUANTITY: THE ANNUAL VALUE AND QUANTITIES ARE ESTIMATED ONLY BASED ON PRIOR USAGE; ACTUAL PURCHASES MAY BE HIGHER OR LOWER DEPENDING ON THE STATE'S NEEDS. THE CONTRACT MAXIMUM IS NOT REFLECTIVE OF ACTUAL USAGE.

DELIVERY: RESPONSIBILITY FOR PRODUCT DELIVERY REMAINS WITH THE CONTRACTOR UNTIL THE PRODUCT IS PROPERLY DELIVERED AND SIGNED FOR IN ACCORDANCE WITH THE OFFICE OF PURCHASING & CONTRACTING TERMS AND CONDITIONS. SHIPMENTS SHALL BE SECURELY AND PROPERLY PACKED, ACCORDING TO ACCEPTED COMMERCIAL PRACTICES, WITHOUT EXTRA CHARGE FOR PACKING CASES OR OTHER CONTAINERS. SUCH CONTAINERS WILL REMAIN THE PROPERTY OF THE STATE UNLESS OTHERWISE STATED. DELIVERED GOODS THAT DO NOT CONFORM TO THE SPECIFICATIONS OR ARE NOT IN GOOD CONDITION UPON RECEIPT SHALL BE REPLACED PROMPTLY BY THE CONTRACTOR.

PRICING: ALL EQUIPMENT PRICING IS TO INCLUDE F.O.B. DELIVERY TO THE ORDERING FACILITY. NO REQUEST FOR EXTRA DELIVERY COST WILL BE HONORED. ALL EQUIPMENT SHALL BE DELIVERED ASSEMBLED, SERVICED, OILED, AND READY FOR IMMEDIATE USE, UNLESS OTHERWISE REQUESTED BY THE PURCHASING AGENCY.

QUALITY: ALL PRODUCTS PROVIDED UNDER THESE AGREEMENTS WILL BE NEW AND UNUSED, UNLESS OTHERWISE STATED. FACTORY SECONDS OR REMANUFACTURED PRODUCTS WILL NOT BE ACCEPTED UNLESS SPECIFICALLY REQUESTED BY THE PURCHASING AGENCY. ALL PRODUCTS PROVIDED BY THE CONTRACTOR MUST MEET ALL FEDERAL, STATE, AND LOCAL STANDARDS FOR QUALITY AND SAFETY REQUIREMENTS. PRODUCTS NOT MEETING THESE STANDARDS WILL BE DEEMED UNACCEPTABLE AND RETURNED TO THE CONTRACTOR FOR CREDIT AT NO CHARGE TO THE STATE.

METHOD OF ORDERING: PURCHASE ORDERS MUST BE USED TO ORDER ITEMS AVAILABLE UNDER THIS CONTRACT. IF VERBAL ORDERS ARE GIVEN A CONFIRMING PURCHASE ORDER MUST BE ISSUED.

INVOICING: ALL INVOICES ARE TO BE RENDERED BY THE CONTRACTOR ON THE VENDOR'S STANDARD BILLHEAD AND FORWARDED DIRECTLY TO THE INSTITUTION OR AGENCY ORDERING MATERIALS OR SERVICES AND SHALL SPECIFY THE ADDRESS TO WHICH PAYMENTS WILL BE SENT.

CANCELLATION: THE STATE SPECIFICALLY RESERVES THE RIGHT TO CANCEL THE CONTRACT, OR ANY PORTION THEREOF, IF, IN THE OPINION OF ITS COMMISSIONER OF BUILDINGS AND GENERAL SERVICES, THE SERVICES OR MATERIALS SUPPLIED BY THE CONTRACTOR ARE NOT SATISFACTORY OR ARE NOT CONSISTENT WITH THE TERMS OF THE CONTRACT

DEFAULT: IN CASE OF DEFAULT OF THE CONTRACTOR, THE STATE MAY PROCURE THE MATERIALS OR SUPPLIES FROM OTHER SOURCES AND HOLD THE CONTRACTOR RESPONSIBLE FOR ANY EXCESS COST OCCASIONED THEREBY, PROVIDED, THAT IF PUBLIC NECESSITY REQUIRES THE USE OF MATERIALS OR SUPPLIES NOT CONFORMING TO THE SPECIFICATIONS THEY MAY BE ACCEPTED AND PAYMENT THEREFORE SHALL BE MADE AT A PROPER REDUCTION IN PRICE.

CONTRACT TERMS: THIS CONTRACT WILL BE SUBJECT TO REVIEW THROUGHOUT ITS TERM. THE STATE WILL CONSIDER CANCELLATION UPON DISCOVERY THAT A VENDOR IS IN VIOLATION OF ANY PORTION OF THE AGREEMENT, INCLUDING AN INABILITY BY THE VENDOR TO PROVIDE THE PRODUCTS, SUPPORT, AND/OR SERVICE OFFERED IN THEIR RESPONSE.

VERMONT STATE COLLEGES: THIS CONTRACT IS ALSO AVAILABLE FOR USE BY THE UNIVERSITY OF VERMONT AND THE VERMONT STATE COLLEGES INC., A SEPARATE CORPORATION, HAVING UNDER ITS JURISDICTION CASTLETON STATE COLLEGE, JOHNSON STATE COLLEGE, LYNDON STATE COLLEGE, COMMUNITY COLLEGE OF VERMONT, AND THE VERMONT TECHNICAL COLLEGE.

TOWNS AND SCHOOLS OF THE STATE OF VERMONT: AT THE BIDDER'S ELECTION POLITICAL SUBDIVISIONS AND INDEPENDENT COLLEGES OF THE STATE MAY PARTICIPATE IN STATE CONTRACTS AT THE SAME PRICES, TERMS AND CONDITIONS. ITEMS FURNISHED TO POLITICAL SUBDIVISIONS AND INDEPENDENT COLLEGES WILL BE BILLED DIRECTLY TO AND PAID FOR BY THE POLITICAL SUBDIVISIONS OR INDEPENDENT COLLEGES AND NEITHER THE STATE NOR ITS COMMISSIONER OF BUILDINGS AND GENERAL SERVICES PERSONALLY OR OFFICIALLY ASSUMES ANY RESPONSIBILITY FOR THESE PAYMENTS.

State of Vermont

Buildings and General Services
Office of Purchasing & Contracting
109 State St
Montpelier VT 05609-3001
USA

CONTRACT



Supplier 0000010383
Valk Manufacturing Co
PO Box 428
New Kingstown PA 17072-0428
USA

Contract ID 0000000000000000000029018	Page 3 of 6
Contract Dates 06/30/2015 to 06/30/2022	Origin CPS
Description: SNOWPLOW BLADE CUTTING EDGES	Contract Maximum \$9,999,990.00
Buyer Name William A Vivian Jr.	Buyer Phone 828-4681
Contract Status Approved	

Phone #: 717-766-0711

Line #	Item ID	Item Desc	UOM	Unit Price	Max Qty	Max Amt
--------	---------	-----------	-----	------------	---------	---------

AGENCIES & DEPARTMENTS ARE REQUESTED TO ADVISE THE PURCHASING AGENT AT ONCE OF THE FAILURE ON THE PART OF THE CONTRACTOR TO FULFILL ANY OF THE TERMS OR CONDITIONS OF THIS CONTRACT.

PLEASE REFER TO THE ASSIGNED CONTRACT NUMBER/PURCHASE ORDER # ON ALL CORRESPONDENCE, DELIVERY DOCUMENTS AND INVOICES.

APRIL 7, 2017
AMENDMENT #01 - TO EXTEND CONTRACT FOR A ONE YEAR PERIOD AT THE SAME PRICES, TERMS AND CONDITIONS.

JUNE 7, 2018
AMENDMENT #02 - TO EXTEND CONTRACT FOR A ONE YEAR PERIOD AT THE SAME PRICES, TERMS AND CONDITIONS WITH THE FOLLOWING EXCEPTIONS:

1). PRICING: DUE TO TARIFFS ON IMPORTED STEEL CURRENTLY IN EFFECT, PLOW BLADE PRICING IS HEREBY REMOVED FROM THE ATTACHED PRODUCT LIST. ORDERING ENTITIES ARE TO REQUEST A QUOTE FROM CONTRACTOR FOR PRICING IN EFFECT AT TIME OF ORDER.

ATTACHMENT C: STANDARD STATE PROVISIONS FOR CONTRACTS AND GRANTS REVISED DECEMBER 15, 2017 IS INCORPORATED INTO THE CONTRACT.

CONTRACTOR CERTIFIES UNDER THE PAINS AND PENALTIES OF PERJURY THAT, AS OF THE DATE THIS CONTRACT AMENDMENT IS SIGNED, CONTRACTOR IS IN GOOD STANDING WITH RESPECT TO, OR IN FULL COMPLIANCE WITH A PLAN TO PAY ANY AND ALL TAXES DUE THE STATE OF VERMONT.

CERTIFICATION REGARDING SUSPENSION OR DEBARMENT. CONTRACTOR CERTIFIES UNDER THE PAINS AND PENALTIES OF PERJURY THAT, AS OF THIS DATE THIS CONTRACT AMENDMENT IS SIGNED, NEITHER PARTY NO PARTY'S PRINCIPALS (OFFICERS, DIRECTORS, OWNERS, OR PARTNERS) ARE PRESENTLY DEBARRED, SUSPENDED, PROPOSED FOR DEBARMENT, DECLARED INELIGIBLE OR EXCLUDED FROM PARTICIPATION IN FEDERAL PROGRAMS, OR PROGRAMS SUPPORTED IN WHOLE OR IN PART BY FEDERAL FUNDS.

PARTY FURTHER CERTIFIES UNDER PAINS AND PENALTIES OF PERJURY THAT, AS OF THE DATE THIS AGREEMENT IS SIGNED, PARTY IS NOT PRESENTLY DEBARRED, SUSPENDED, NOR NAMED ON THE STATE'S DEBARMENT LIST AT: [HTTP://BGS.VERMONT.GOV/PURCHASING/DEBARMENT](http://BGS.VERMONT.GOV/PURCHASING/DEBARMENT).

CHILD SUPPORT (APPLICABLE TO NATURAL PERSONS ONLY; NOT APPLICABLE TO CORPORATIONS, PARTNERSHIPS OR LLCs): CONTRACTOR IS UNDER NO OBLIGATION TO PAY CHILD SUPPORT OR IS IN GOOD STANDING WITH RESPECT TO OR IN FULL COMPLIANCE WITH A PLAN TO PAY ANY AND ALL CHILD SUPPORT PAYABLE UNDER A SUPPORT ORDER AS OF THE DATE OF THIS AMENDMENT.

AMENDMENT#3 (MAY 2019). THIS CHANGE ORDER EXERCISES THE THIRD OF THE FIVE ONE-YEAR OPTIONS TO RENEW, AND EXTENDS THE CONTRACT FOR ONE ADDITIONAL YEAR TO 06/30/2020, AT THE SAME PRICING, TERMS, AND CONDITIONS.

STATE OF VERMONT ATTACHMENT C: STANDARD STATE CONTRACT PROVISIONS DATED DECEMBER 15, 2017 IS ATTACHED AND INCORPORATED AS PART OF THIS ORDER.

CONTRACTOR CERTIFIES UNDER THE PAINS AND PENALTIES OF PERJURY THAT AS OF THE DATE THIS AMENDMENT IS SIGNED, CONTRACT IS IN GOOD STANDING TO OR IN FULL COMPLIANCE WITH A PLAN TO PAY ANY AND ALL TAXES DUE THE STATE OF VERMONT.

CERTIFICATION REGARDING SUSPENSION OR DISBARMENT. CONTRACTOR CERTIFIES UNDER THE PAINS AND PENALTIES OF PERJURY THAT, AS OF THIS DATE THIS CONTRACT AMENDMENT IS SIGNED, NEITHER PARTY NO PARTY'S PRINCIPALS (OFFICERS, DIRECTORS, OWNERS, OR PARTNERS) ARE PRESENTLY DEBARRED, SUSPENDED, PROPOSED FOR DEBARMENT, DECLARED INELIGIBLE OR EXCLUDED FROM PARTICIPATION IN FEDERAL PROGRAMS, OR PROGRAMS SUPPORTED IN WHOLE OR IN PART BY FEDERAL FUNDS.

State of Vermont

Buildings and General Services
Office of Purchasing & Contracting
109 State St
Montpelier VT 05609-3001
USA

CONTRACT



Supplier 0000010383
Valk Manufacturing Co
PO Box 428
New Kingstown PA 17072-0428
USA

Contract ID 000000000000000000029018	Page 4 of 6
Contract Dates 06/30/2015 to 06/30/2022	Origin CPS
Description: SNOWPLOW BLADE CUTTING EDGES	Contract Maximum \$9,999,990.00
Buyer Name William A Vivian Jr.	Buyer Phone 828-4681
Contract Status Approved	

Phone #: 717-766-0711

Line #	Item ID	Item Desc	UOM	Unit Price	Max Qty	Max Amt
--------	---------	-----------	-----	------------	---------	---------

CHILD SUPPORT (APPLICABLE TO NATURAL PERSONS ONLY; NOT APPLICABLE TO CORPORATIONS, PARTNERSHIPS OR LLCs):

CONTRACTOR IS UNDER NO OBLIGATION TO PAY CHILD SUPPORT OR IS IN GOOD STANDING WITH RESPECT TO OR IN FULL COMPLIANCE WITH A PLAN TO PAY ANY AND ALL CHILD SUPPORT PAYABLE UNDER A SUPPORT ORDER AS OF THE DATE OF THIS AMENDMENT.

PARTY FURTHER CERTIFIES UNDER PAINS AND PENALTIES OF PERJURY THAT, AS OF THE DATE THIS AGREEMENT IS SIGNED, PARTY IS NOT PRESENTLY DEBARRED, SUSPENDED, NOR NAMED ON THE STATE'S DEBARMENT LIST AT: [HTTP://BGS.VERMONT.GOV/PURCHASING/DEBARMENT](http://BGS.VERMONT.GOV/PURCHASING/DEBARMENT).

STATE OF VERMONT
CONTRACT AMENDMENT #4

It is hereby agreed by and between the State of Vermont, Office of Purchasing and Contracting (the "State") and Valk Manufacturing Company Inc. , with a principal place of business in New Kingstown, PA (the "Contractor") that the contract between them originally dated as of June 30, 2015, Contract # 29018, as amended to date, (the "Contract") is hereby amended as follows:

II. Contract Term. The Contract end date, wherever such reference appears in the Contract, shall be changed from June 30, 2020 to June 30, 2021. The Contract Term may be renewed for one additional one-year period at the discretion of the State.

Taxes Due to the State. Contractor certifies under the pains and penalties of perjury that, as of the date this contract amendment is signed, the Contractor is in good standing with respect to, or in full compliance with a plan to pay, any and all taxes due the State of Vermont.

Child Support (Applicable to natural persons only; not applicable to corporations, partnerships or LLCs). Contractor is under no obligation to pay child support or is in good standing with respect to or in full compliance with a plan to pay any and all child support payable under a support order as of the date of this amendment.

Certification Regarding Suspension or Debarment. Contractor certifies under the pains and penalties of perjury that, as of the date this contract amendment is signed, neither Contractor nor Contractor's principals (officers, directors, owners, or partners) are presently debarred, suspended, proposed for debarment, declared ineligible or excluded from participation in federal programs, or programs supported in whole or in part by federal funds.

Contractor further certifies under pains and penalties of perjury that, as of the date this contract amendment is signed, Contractor is not presently debarred, suspended, nor named on the State's debarment list at: <http://bgs.vermont.gov/purchasing-contracting/debarment>

This document consists of 5 pages. Except as modified by this Amendment No. 4, all provisions of the Contract remain in full force and effect.

STATE OF VERMONT CONTACT:
BILL VIVIAN
PURCHASING AGENT
802-828-4681
FAX 802-828-2222
BILL.VIVIAN@Vermont.gov

STATE OF VERMONT June 2021
CONTRACT AMENDMENT 5

It is hereby agreed by and between the State of Vermont, Office of Purchasing and Contracting (the "State") and Valk Manufacturing Co, with a principal place of business in New Kingstown, PA (the "Contractor") that the

State of Vermont

Buildings and General Services
Office of Purchasing & Contracting
109 State St
Montpelier VT 05609-3001
USA

CONTRACT



Supplier 0000010383
Valk Manufacturing Co
PO Box 428
New Kingstown PA 17072-0428
USA

Contract ID 0000000000000000000029018	Page 5 of 6
Contract Dates 06/30/2015 to 06/30/2022	Origin CPS
Description: SNOWPLOW BLADE CUTTING EDGES	Contract Maximum \$9,999,990.00
Buyer Name William A Vivian Jr.	Buyer Phone 828-4681
Contract Status Approved	

Phone #: 717-766-0711

Line #	Item ID	Item Desc	UOM	Unit Price	Max Qty	Max Amt
--------	---------	-----------	-----	------------	---------	---------

contract between them originally dated as of June 30, 2015, Contract # 29018, as amended to date, (the "Contract") is hereby amended as follows:

I. Contract Term. The Contract end date, wherever such reference appears in the Contract, shall be changed from June 30, 2021 to June 20, 2022.

Taxes Due to the State. Contractor certifies under the pains and penalties of perjury that, as of the date this contract amendment is signed, the Contractor is in good standing with respect to, or in full compliance with a plan to pay, any and all taxes due the State of Vermont.

Child Support (Applicable to natural persons only; not applicable to corporations, partnerships or LLCs). Contractor is under no obligation to pay child support or is in good standing with respect to or in full compliance with a plan to pay any and all child support payable under a support order as of the date of this amendment.

Certification Regarding Suspension or Debarment. Contractor certifies under the pains and penalties of perjury that, as of the date this contract amendment is signed, neither Contractor nor Contractor's principals (officers, directors, owners, or partners) are presently debarred, suspended, proposed for debarment, declared ineligible or excluded from participation in federal programs, or programs supported in whole or in part by federal funds.

Contractor further certifies under pains and penalties of perjury that, as of the date this contract amendment is signed, Contractor is not presently debarred, suspended, nor named on the State's debarment list at: <http://bgs.vermont.gov/purchasing-contracting/debarment>

Sole Source Contract for Services. This Contract results from a "sole source" procurement under State of Vermont Administrative Bulletin 3.5 process and Contractor hereby certifies that it is and will remain in compliance with the campaign contribution restrictions under 17 V.S.A. § 2950.

SOV Cybersecurity Standard 19-01. All products and service provided to or for the use of the State under this Contract shall be in compliance with State of Vermont Cybersecurity Standard 19-01, which Contractor acknowledges has been provided to it, and is available on-line at the following URL:<https://digitalservices.vermont.gov/cybersecurity/cybersecurity-standards-and-directives>

This document consists of 6 pages. Except as modified by this Amendment No. 5, all provisions of the Contract remain in full force and effect.

STATE OF VERMONT July 2021
CONTRACT AMENDMENT 6

It is hereby agreed by and between the State of Vermont, Office of Purchasing and Contracting (the "State") and Valk Manufacturing Co, with a principal place of business in New Kingstown, PA (the "Contractor") that the contract between them originally dated as of June 30, 2015, Contract # 29018, as amended to date, (the "Contract") is hereby amended as follows:

I. Contract Term. The Contract end date, wherever such reference appears in the Contract, shall be changed from June 20, 2022 to June 30, 2022.

Taxes Due to the State. Contractor certifies under the pains and penalties of perjury that, as of the date this contract amendment is signed, the Contractor is in good standing with respect to, or in full compliance with a plan to pay, any and all taxes due the State of Vermont.

Child Support (Applicable to natural persons only; not applicable to corporations, partnerships or LLCs). Contractor is under no obligation to pay child support or is in good standing with respect to or in full compliance with a plan to pay any and all child support payable under a support order as of the date of this amendment.

Certification Regarding Suspension or Debarment. Contractor certifies under the pains and penalties of perjury that, as of the date this contract amendment is signed, neither Contractor nor Contractor's principals

State of Vermont

Buildings and General Services
Office of Purchasing & Contracting
109 State St
Montpelier VT 05609-3001
USA

CONTRACT



Supplier 0000010383
Valk Manufacturing Co
PO Box 428
New Kingstown PA 17072-0428
USA

Contract ID 0000000000000000000029018	Page 6 of 6
Contract Dates 06/30/2015 to 06/30/2022	Origin CPS
Description SNOWPLOW BLADE CUTTING EDGES	Contract Maximum \$9,999,990.00
Buyer Name William A Vivian Jr.	Buyer Phone 828-4681
	Contract Status Approved

Phone #: 717-766-0711

Line #	ItemID	ItemDesc	UOM	Unit Price	Max Qty	Max Amt
--------	--------	----------	-----	------------	---------	---------

(officers, directors, owners, or partners) are presently debarred, suspended, proposed for debarment, declared ineligible or excluded from participation in federal programs, or programs supported in whole or in part by federal funds.

Contractor further certifies under pains and penalties of perjury that, as of the date this contract amendment is signed, Contractor is not presently debarred, suspended, nor named on the State's debarment list at: <http://bgs.vermont.gov/purchasing-contracting/debarment>

Sole Source Contract for Services. This Contract results from a "sole source" procurement under State of Vermont Administrative Bulletin 3.5 process and Contractor hereby certifies that it is and will remain in compliance with the campaign contribution restrictions under 17 V.S.A. § 2950.

SOV Cybersecurity Standard 19-01. All products and service provided to or for the use of the State under this Contract shall be in compliance with State of Vermont Cybersecurity Standard 19-01, which Contractor acknowledges has been provided to it, and is available on-line at the following

URL: <https://digitalservices.vermont.gov/cybersecurity/cybersecurity-standards-and-directives>

This document consists of 7 pages. Except as modified by this Amendment No. 6, all provisions of the Contract remain in full force and effect.

WE THE UNDERSIGNED PARTIES AGREE TO BE BOUND BY THIS CONTRACT

By the STATE of VERMONT

By the CONTRACTOR

Date: E-SIGNED by Jennifer Fitch
on 2021-07-27 02:24:44 GMT

Date: 7/26/21

Signature: _____

Signature: Dan C. Cribari

Name: Jennifer Fitch

Name: Dan C. Cribari

Commissioner - Buildings and General Services

Title: _____

Title: Sales Manager, Snow Plow Division

Email: _____

Email: plowsales@valkmfg.com

STATE OF NEBRASKA CONTRACT AWARD

State Purchasing Bureau
1526 K Street, Suite 130
Lincoln, Nebraska 68508

Telephone: (402) 471-6500
Fax: (402) 471-2089

CONTRACT NUMBER
15161 OC

PAGE 1 of 1	ORDER DATE 06/30/20
BUSINESS UNIT 9000	BUYER CHRISTIE KELLY (AS)
VENDOR NUMBER: 553151	
VENDOR ADDRESS: VALK MANUFACTURING COMPANY PO BOX 428 NEW KINGSTOWN PA 17072-0428	

AN AWARD HAS BEEN MADE TO THE CONTRACTOR NAMED ABOVE FOR THE FURNISHING OF MATERIALS AND/OR SERVICES AS LISTED BELOW FOR THE PERIOD:

JULY 01, 2020 THROUGH JUNE 30, 2021

NO ACTION ON THE PART OF THE CONTRACTOR NEEDS TO BE TAKEN AT THIS TIME. ORDERS FOR THE MATERIALS AND/OR SERVICES WILL BE MADE AS NEEDED BY THE VARIOUS AGENCIES OF THE STATE.

THIS CONTRACT IS NOT AN EXCLUSIVE CONTRACT TO FURNISH THE MATERIALS AND/OR SERVICES SHOWN BELOW, AND DOES NOT PRECLUDE THE PURCHASE OF SIMILAR MATERIALS AND/OR SERVICES FROM OTHER SOURCES.

THE STATE RESERVES THE RIGHT TO EXTEND THE PERIOD OF THIS CONTRACT BEYOND THE TERMINATION DATE WHEN MUTUALLY AGREEABLE TO THE CONTRACTOR AND THE STATE OF NEBRASKA.

15161 OC Valk Manufacturing Company verbiage

Awarded from NASPO Master Agreement No. 29018

Contract to supply and deliver Snow plow Blade cutting Edges to State of Nebraska agencies for the period of July 01, 2020 through June 30, 2021, with the option to renew for one (1) additional one (1) year period per the terms, conditions and specification of the "Request for Proposal".

Payment Terms: Net 45

For the File: This RFP and Contract are bid and awarded by the State of Vermont, on behalf of NASPO ValuePoint. All backup bids, etc are retained by the State of Vermont, Buildings and General Services, Office of Purchasing and Contracting. The NASPO ValuePoint/Snowplow Blade cutting Edges Master Agreement became effective June 30, 2015.

Vendor Contact: Dan Cribari
Phone: (717) 766-0711 ext 122
Fax: 717-697-6297
plowsales@valkmfg.com

This is the second renewal of the contract as established by Amendment Three of the Master Agreement 29010. (mh 06/30/20)

Line	Description	Estimated Quantity	Unit of Measure	Unit Price
1	SNOWPLOW BLADES & ACCESSORIES	1,000,000.0000	\$	1.0000

Christie Kelly by BMS

[Signature]
BUYER
7/7/2020
MATERIEL ADMINISTRATOR

**PARTICIPATING ADDENDUM
 NASPO VALUEPOINT
 SNOWPLOW BLADE CUTTING EDGES
 Administered by the State of Vermont (hereinafter "Lead State")**

MASTER AGREEMENT
 Amendment 15161 OC

Valk Manufacturing Company
 Master Agreement No: 29018
 (hereinafter "Contractor")

And

State of Nebraska, Contract 15161 OC
 (hereinafter "Participating State/Entity")

Page 1 of 2

THIS AMENDMENT TWO is by and between the State of Nebraska (Participating State), and Valk Manufacturing Company (Contractor).

WHEREAS, the Lead State (Vermont) has a Contract with the Contractor identified as Snowplow Blade Cutting Edges #29018 to provide public Snowplow Blade Cutting Edges for use by state agencies and other entities. The State has entered into a Participating Addendum with the Contract identified as 15161 OC.

WHEREAS, the terms of the Contract specifically state that the contract may be extension per agreement by both parties. The State of Nebraska wishes to continue to take advantage of the existing contract.

NOW, THEREFORE, it is agreed by the parties to amend the Contract as follows:

Effective July 1, 2020:

1. **CHANGES:** The purpose of this Amendment Two is as follows:
 - a. Contract term is extended from July 1, 2020 through June 30, 2021

Terms and conditions inconsistent with, contrary or in addition to the terms and conditions of this Addendum and the Price Agreement, together with its exhibits, shall not be added to or incorporated into this Addendum or the Price Agreement and its exhibits, by any subsequent purchase order or otherwise, and any such attempts to add or incorporate such terms and conditions are hereby rejected. The terms and conditions of this Addendum and the Price Agreement and its exhibits shall prevail and govern in the case of any such inconsistent or additional terms. This Addendum applies only in the jurisdiction of the Participating State or Participating Entity, which has executed this Addendum.

IN WITNESS WHEREOF, the parties have executed this Addendum as of the date of execution by both parties below.

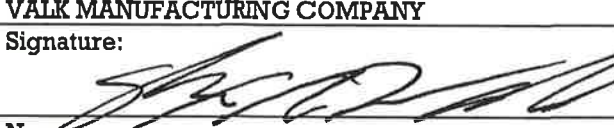
Participating State: STATE OF NEBRASKA	Contractor: VALK MANUFACTURING COMPANY
Signature: 	Signature: 
Name: Doug Carlson	Name: Max Woodward
Title: Materiel Administrator	Title: Vice President
Date: 7/7/2020	Date: 6/30/20

STATE OF NEBRASKA CONTRACT AWARD

State Purchasing Bureau
1526 K Street, Suite 130
Lincoln, Nebraska 68508

Telephone: (402) 471-6500
Fax: (402) 471-2089

CONTRACT NUMBER
15161 OC

PAGE 1 of 1	ORDER DATE 07/01/19
BUSINESS UNIT 9000	BUYER RENE BOTTS (AS)
VENDOR NUMBER: 553151	
VENDOR ADDRESS: VALK MANUFACTURING COMPANY PO BOX 428 NEW KINGSTOWN PA 17072-0428	

AN AWARD HAS BEEN MADE TO THE CONTRACTOR NAMED ABOVE FOR THE FURNISHING OF MATERIALS AND/OR SERVICES AS LISTED BELOW FOR THE PERIOD:

JULY 01, 2019 THROUGH JUNE 30, 2020

NO ACTION ON THE PART OF THE CONTRACTOR NEEDS TO BE TAKEN AT THIS TIME. ORDERS FOR THE MATERIALS AND/OR SERVICES WILL BE MADE AS NEEDED BY THE VARIOUS AGENCIES OF THE STATE.

THIS CONTRACT IS NOT AN EXCLUSIVE CONTRACT TO FURNISH THE MATERIALS AND/OR SERVICES SHOWN BELOW, AND DOES NOT PRECLUDE THE PURCHASE OF SIMILAR MATERIALS AND/OR SERVICES FROM OTHER SOURCES.

THE STATE RESERVES THE RIGHT TO EXTEND THE PERIOD OF THIS CONTRACT BEYOND THE TERMINATION DATE WHEN MUTUALLY AGREEABLE TO THE CONTRACTOR AND THE STATE OF NEBRASKA.

15161 OC Valk Manufacturing Company verbiage

Awarded from NASPO Master Agreement No. 29018

Contract to supply and deliver Snow plow Blade cutting Edges to State of Nebraska agencies for the period of July 01, 2019 through June 30, 2020, with the option to renew for two (2) additional one (1) year periods per the terms, conditions and specification of the "Request for Proposal".

Payment Terms: Net 45

For the File: This RFP and Contract are bid and awarded by the State of Vermont, on behalf of NASPO ValuePoint. All backup bids, etc are retained by the State of Vermont, Buildings and General Services, Office of Purchasing and Contracting. The NASPO ValuePoint/Snowplow Blade cutting Edges Master Agreement became effective June 30, 2015.

Vendor Contact: Dan Cribari
Phone: (717) 766-0711 ext 122
Fax: 717-697-6297
plowsales@valkmfg.com

(bs 06/20/19)

This is the first renewal of the contract as established by Amendment Three of the Master Agreement 29010. (ms 07/01/19)

Line	Description	Estimated Quantity	Unit of Measure	Unit Price
1	SNOWPLOW BLADES & ACCESSORIES	1,000,000.0000	\$	1.0000

7-1-19
BY: *[Signature]* 7/1/2019
BUYER
[Signature] 7/2/19
MATERIEL ADMINISTRATOR

**PARTICIPATING ADDENDUM
NASPO VALUEPOINT
SNOWPLOW BLADE CUTTING EDGES
Administered by the State of Vermont (hereinafter "Lead State")**

**MASTER AGREEMENT
Amendment One**

Valk Manufacturing Company
Master Agreement No: 29018
(hereinafter "Contractor")

And

State of Nebraska, Contract 15161 OC
(hereinafter "Participating State/Entity")

Page 1 of 2

THIS AMENDMENT ONE is by and between the State of Nebraska (Participating State), and Valk Manufacturing Company (Contractor).

WHEREAS, the Lead State (Vermont) has a Contract with the Contractor identified as Snowplow Blade Cutting Edges #29018 to provide public Snowplow Blade Cutting Edges for use by state agencies and other entities. The State has entered into a Participating Addendum with the Contract identified as 15161 OC.

WHEREAS, the terms of the Contract specifically state that the contract may be extension per agreement by both parties. The State of Nebraska wishes to continue to take advantage of the existing contract.



NOW, THEREFORE, it is agreed by the parties to amend the Contract as follows:

Effective July 1, 2019:

1. **CHANGES:** The purpose of this Amendment One is as follows:
 - a. Contract term is extended from July 1, 2019 through June 30, 2020.

Terms and conditions inconsistent with, contrary or in addition to the terms and conditions of this Addendum and the Price Agreement, together with its exhibits, shall not be added to or incorporated into this Addendum or the Price Agreement and its exhibits, by any subsequent purchase order or otherwise, and any such attempts to add or incorporate such terms and conditions are hereby rejected. The terms and conditions of this Addendum and the Price Agreement and its exhibits shall prevail and govern in the case of any such inconsistent or additional terms. This Addendum applies only in the jurisdiction of the Participating State or Participating Entity, which has executed this Addendum.

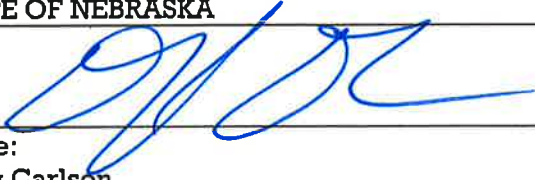
IN WITNESS WHEREOF, the parties have executed this Addendum as of the date of execution by both parties below.

Participating State: STATE OF NEBRASKA	Contractor: VALK MANUFACTURING COMPANY
By: 	By: 
Name: Doug Carlson	Name: <i>Max Hoodward</i>
Title: Materiel Administrator	Title: <i>Vice President</i>
Date: <i>7/2/19</i>	Date: <i>6/27/19</i>

STATE OF NEBRASKA CONTRACT AWARD

State Purchasing Bureau
1526 K Street, Suite 130
Lincoln, Nebraska 68508

Telephone: (402) 471-6500
Fax: (402) 471-2089

CONTRACT NUMBER
15161 OC

PAGE 1 of 1	ORDER DATE 06/20/19
BUSINESS UNIT 9000	BUYER RENE BOTTS (AS)
VENDOR NUMBER: 553151	
VENDOR ADDRESS: VALK MANUFACTURING COMPANY PO BOX 428 NEW KINGSTOWN PA 17072-0428	

AN AWARD HAS BEEN MADE TO THE CONTRACTOR NAMED ABOVE FOR THE FURNISHING OF MATERIALS AND/OR SERVICES AS LISTED BELOW FOR THE PERIOD:

JUNE 10, 2019 THROUGH JUNE 30, 2019

NO ACTION ON THE PART OF THE CONTRACTOR NEEDS TO BE TAKEN AT THIS TIME. ORDERS FOR THE MATERIALS AND/OR SERVICES WILL BE MADE AS NEEDED BY THE VARIOUS AGENCIES OF THE STATE.

THIS CONTRACT IS NOT AN EXCLUSIVE CONTRACT TO FURNISH THE MATERIALS AND/OR SERVICES SHOWN BELOW, AND DOES NOT PRECLUDE THE PURCHASE OF SIMILAR MATERIALS AND/OR SERVICES FROM OTHER SOURCES.

THE STATE RESERVES THE RIGHT TO EXTEND THE PERIOD OF THIS CONTRACT BEYOND THE TERMINATION DATE WHEN MUTUALLY AGREEABLE TO THE CONTRACTOR AND THE STATE OF NEBRASKA.

15161 OC Valk Manufacturing Company verbiage

Awarded from NASPO Master Agreement No. 29018

Contract to supply and deliver Snow plow Blade cutting Edges to State of Nebraska agencies for the period of June 10, 2019 through June 30, 2019, with the option to renew for three (3) additional one (1) year periods per the terms, conditions and specification of the "Request for Proposal".

Payment Terms: Net 45

For the File: This RFP and Contract are bid and awarded by the State of Vermont, on behalf of NASPO ValuePoint. All backup bids, etc are retained by the State of Vermont, Buildings and General Services, Office of Purchasing and Contracting. The NASPO ValuePoint/Snowplow Blade cutting Edges Master Agreement became effective June 30, 2015.

Vendor Contact: Dan Cribari
Phone: (717) 766-0711 ext 122
Fax: 717-697-6297
plowsales@valkmfg.com

(bs 06/20/19)

Line	Description	Estimated Quantity	Unit of Measure	Unit Price
1	SNOWPLOW BLADES & ACCESSORIES	1,000,000.0000	\$	1.0000

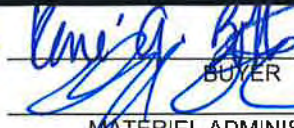
6-21-19

 BUYER
 June 21, 2019
 6/25/19
 MATERIEL ADMINISTRATOR

15161 OC, Valk Manufacturing Company

Snowplow Blade Cutting Edges

Contract Summary

This is a Statewide Contract in participation with NASPO ValuePoint for the purchase of **Snowplow Blade Cutting Edges**.

State of Nebraska Contract Manager

René A. Botts, Buyer III

rene.botts@nebraska.gov

Phone: (402)471-0971

Important Valk Manufacturing Company Contacts:

Obtain quotes and submit Purchase Orders:

Dan Cribari

plowsales@valkmfg.com

Phone: (717) 766-0711 ext 122

Delivery Issues:

Dan Cribari

Technical Information:

Dan Cribari

Invoicing:

Danny Snyder

ds@valkmfg.com

Phone: (717) 766-0771 ext 145

4. Lease Agreements: "Reserved"

5. Primary Contacts: The primary contact individuals for this Participating Addendum are as follows (or their named successors):

Contractor

Name	Dan Cribari, Sales Manager, Snow Plow Division, Valk Manufacturing Company
Address	PO Box 428, New Kingstown, PA 17072-0428
Telephone	717-766-0711 ext 122
Fax	717-697-6297
E-mail	plowsales@valkmfg.com

Participating Entity

Name	René A. Botts, State of Nebraska
Address	1526 K ST, Suite 130
Telephone	402-471-0971
Fax	402-471-2089
E-mail	Rene.botts@nebraska.gov

6. Subcontractors: All [contractor] dealers and resellers authorized in the State of Nebraska, as shown on the dedicated [contractor] (cooperative contract) website, are approved to provide sales and service support to participants in the NASPO ValuePoint Master Agreement. The [contractors] dealer's participation will be in accordance with the terms and conditions set forth in the aforementioned Master Agreement.

7. Orders: Any Order placed by a Participating Entity or Purchasing Entity for a Product and/or Service available from this Master Agreement shall be deemed to be a sale under (and governed by the prices and other terms and conditions) of the Master Agreement unless the parties to the Order agree in writing that another contract or agreement applies to such Order.

IN WITNESS WHEREOF, the parties have executed this Addendum as of the date of execution by both parties below.

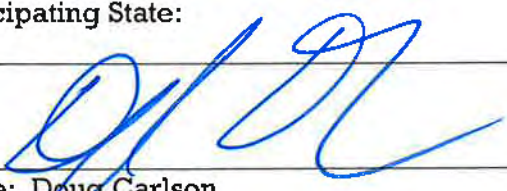
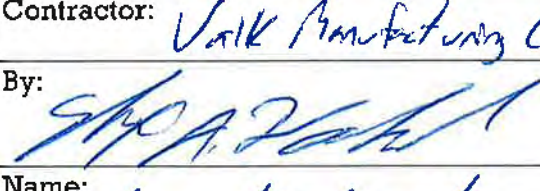
Participating State:	Contractor: <i>Valk Manufacturing Company</i>
By: 	By: 
Name: Doug Carlson	Name: <i>Max Woodward</i>
Title: Materiel Administrator	Title: <i>Vice President</i>
Date: <i>6/25/19</i>	Date: <i>6/17/19</i>

For questions on executing a participating addendum, please contact:

NASPO ValuePoint

Cooperative Development Coordinator	Tim Hay
Telephone	503-428-5705
E-mail	thay@naspovaluepoint.org

[Please email fully executed PDF copy of this document to PA@naspovaluepoint.org to support documentation of participation and posting in appropriate data bases]

PARTICIPATING ADDENDUM
NASPO VALUEPOINT
SNOWPLOW BLADE CUTTING EDGES
Administered by the State of Vermont (hereinafter "Lead State")

MASTER AGREEMENT
Valk Manufacturing Company
Master Agreement No: 29018
(hereinafter "Contractor")

And

State of Nebraska, Contract 15161 OC
(hereinafter "Participating State/Entity")

1. **Scope:** This addendum covers the Snowplow Blade Cutting Edges led by the State of Vermont for use by state agencies and other entities located in the Participating **State/Entity** authorized by that state's statutes to utilize **state/entity** contracts with the prior approval of the state's chief procurement official.

2. **Participation:** Use of specific NASPO ValuePoint cooperative contracts by agencies, political subdivisions and other entities (including cooperatives) authorized by an individual state's statutes to use **state/entity** contracts are subject to the prior approval of the respective State Chief Procurement Official. Issues of interpretation and eligibility for participation are solely within the authority of the State Chief Procurement Official.

3. **Participating State Modifications or Additions to Master Agreement:**

(These modifications or additions apply only to actions and relationships within the Participating Entity.)

IMPORTANT NOTICE: Pursuant to Neb. Rev. Stat. § 84-602.04, State contracts in effect as of January 1, 2014, and contracts entered into thereafter, must be posted to a public website. The resulting contract, the ITB, and the successful Bidder's bid or response will be posted to a public website managed by DAS, which can be found at:

<https://statecontracts.nebraska.gov/>

Contractor may request that proprietary information be excluded from the posting. The Contractor must identify the proprietary information, mark the proprietary information according to state law, and submit the proprietary information in a separate container or envelope marked conspicuously in black ink with the words "PROPRIETARY INFORMATION". The Contractor must submit a detailed written document showing that the release of the proprietary information would give a business advantage to named business competitor(s) and explain how the named business competitor(s) will gain an actual business advantage by disclosure of information. The mere assertion that information is proprietary or that a speculative business advantage might be gained is not sufficient. (See Attorney General Opinion No. 92068, April 27, 1992) **THE CONTRACTOR MAY NOT ASSERT THAT THE ENTIRE /PARTICIPATING ADDENDUM IS PROPRIETARY. COSTS WILL NOT BE CONSIDERED PROPRIETARY AND ARE A PUBLIC RECORD IN THE STATE OF NEBRASKA.** The State will then determine, in its discretion, if the interests served by nondisclosure outweighs any public purpose served by disclosure. (See Neb. Rev. Stat. § 84-712.05(3)). The Contractor will be notified of the agency's decision. Absent a State determination that information is proprietary, the State will consider all information a public record subject to release regardless of any assertion that the information is proprietary.

If the agency determines it is required to release proprietary information, the Contractor will be informed. It will be the Contractor's responsibility to defend the Contractor's asserted interest in non-disclosure.

To facilitate such public postings, with the exception of proprietary information, the State of Nebraska reserves a royalty-free, nonexclusive, and irrevocable right to copy, reproduce, publish, post to a website, and authorize others to use the documents, or otherwise use the Participating Addendum or other documents received with regard to the Participating Addendum. Contractor specifically waives any copyright or other protection the Participating Addendum or other documents may have. This reservation and waiver is a prerequisite for entering into this Participating Addendum.

Contractor agrees not to sue, file a claim, or make a demand of any kind, and will indemnify and hold harmless the State and its employees, volunteers, agents, and its elected and appointed officials from and against any and all claims, liens, demands, damages, liability, actions, causes of action, losses, judgments, costs, and expenses of every nature, including investigation costs and expenses, settlement costs, and attorney fees and expenses, sustained or asserted against the State, arising out of, resulting from, or attributable to the posting of the Participating Addendum or documents.

I. GENERAL

A. CONTRACT PERIOD: June 10, 2019 through June 30, 2019

B. NEGOTIATIONS

Supplier is expected to read the Terms and Conditions and either accept or provide alternative language for each clause using "Track Changes". The Supplier should also provide an explanation of why the Supplier provided alternate language using "Comments". The State reserves the right to negotiate proposed alternative language. If the State and Supplier fail to agree on the final Terms and Conditions, the State reserves the right to withdraw the offer.

The Supplier should submit any license, user agreement, service level agreement, or similar documents that the Supplier wants incorporated in the Participating Addendum. The Supplier must submit a copy of these documents in an editable Word format. The State will not consider incorporation of any document not submitted prior to signing the Participating Addendum. These documents shall be subject to negotiation and will be incorporated as addendums if agreed to by the Parties.

If a conflict or ambiguity arises after the documents are negotiated and agreed to, the documents shall be interpreted as follows:

- If only one (1) Party's document has a particular clause then that clause shall control;
- If both Party's documents have a similar clause, but the clauses do not conflict, the clauses shall be read together;
- If both Party's documents have a similar clause, but the clauses conflict, the State's clause shall control.

C. DOCUMENTS/ORDER OF PRECEDENCE

The Participating Addendum shall incorporate the following documents:

1. Participating Addendum
2. Master Agreement
3. Amendments/Addendums.
4. The Solicitation
5. Contractor's Response to the Solicitation

These documents constitute the entirety of the Participating Addendum.

By incorporation of the Master Agreement in the Participating Addendum, the Master Agreement shall be read as being entered into by the State of Nebraska and interpreted consistent with Nebraska state law. These documents constitute the entirety of the Participating Addendum.

Unless otherwise specifically stated in a future Participating Addendum amendment, in case of any conflict between the incorporated documents, the documents shall govern in the following order of preference with number one (1) receiving preference over all other documents and with each lower numbered document having preference over any higher numbered document: 1) Amendment to the executed Participating Addendum or Master Agreement with the most recent dated amendment having the highest priority, 2) executed Participating Addendum and any attached Addenda, 3) executed Master Agreement and any Addendum, 4) Statement of Work, 5) the Solicitation, and 6) Contractor's Response to the Solicitation.

Any ambiguity or conflict in the Participating Addendum discovered after execution, not otherwise addressed herein, shall be resolved in accordance with the rules of Participating Addendum Interpretation as established in the State of Nebraska.

D. GOVERNING LAW

Notwithstanding any other provision of this Participating Addendum, or any amendment or addendum(s) entered into contemporaneously or at a later time, the parties understand and agree that, (1) the State of Nebraska is a sovereign state and its authority to contract is therefore subject to limitation by the State's Constitution, statutes, common law, and regulation; (2) this contract will be interpreted and enforced under the laws of the State of Nebraska; (3) any action to enforce the provisions of this agreement must be brought in the State of Nebraska per state law; (4) the person signing this contract on behalf of the State of Nebraska does not have the authority to waive the State's sovereign immunity, statutes, common law, or regulations; (5) the indemnity, limitation of liability, remedy, and other similar provisions of the final contract, if any, are entered into subject to the State's Constitution, statutes, common law, regulations, and sovereign immunity; and, (6) all terms and conditions of the final contract, including but not limited to the clauses concerning third-party use, licenses, warranties, limitations of liability, governing law and venue, usage verification, indemnity, liability, remedy or other similar provisions of the final contract are entered into specifically subject to the State's Constitution, statutes, common law, regulations, and sovereign immunity.

The Parties must comply with all applicable local, state and federal laws, ordinances, rules, orders, and regulations.

E. AMENDMENT

This Participating Addendum may be amended in writing, within scope, upon the agreement of both parties.

F. CHANGE ORDERS OR SUBSTITUTIONS

The State and the Contractor, upon the written agreement, may make changes to the contract within the general scope of the ITB. Changes may involve specifications, the quantity of work, or such other items as the State may find necessary or desirable. Corrections of any deliverable, service, or work required pursuant to the contract shall not be deemed a change. The Contractor may not claim forfeiture of the contract by reasons of such changes.

The State or Contractor may prepare a written description of the work required due to the change and the Contractor shall prepare an itemized cost sheet for the change. Changes in work and the amount of compensation to be paid to the Contractor shall be determined in accordance with applicable unit prices if any, a pro-rated value, or through negotiations. The State shall not incur a price increase for changes that should have been included in the Contractor's bid, were foreseeable, or result from difficulties with or failure of the Contractor's bid or performance.

No change shall be implemented by the Contractor until approved by the State, and the Contract is amended to reflect the change and associated costs, if any. If there is a dispute regarding the cost, but both parties agree that immediate implementation is necessary, the change may be implemented, and cost negotiations may continue with both Parties retaining all remedies under the contract and law.

In the event any product is discontinued or replaced upon mutual consent during the contract period, the State reserves the right to amend this contract to include the alternate product at the same price.

*****Supplier will not substitute any item that has been awarded without prior written approval of SPB*****

G. NOTICE OF POTENTIAL CONTRACTOR BREACH

If Contractor breaches the Participating Addendum or anticipates breaching the Participating Addendum, the Contractor shall immediately give written notice to the State. The notice shall explain the breach or potential breach, a proposed cure, and may include a request for a waiver of the breach if so desired. The State may, in its discretion, temporarily or permanently waive the breach. By granting a waiver, the State does not forfeit any rights or remedies to which the State is entitled by law or equity, or pursuant to the provisions of the Participating Addendum. Failure to give immediate notice, however, may be grounds for denial of any request for a waiver of a breach.

H. BREACH

Either Party may terminate the Participating Addendum, in whole or in part, if the other Party breaches its duty to perform its obligations under the contract in a timely and proper manner. Termination requires written notice of default and a thirty (30) calendar day (or longer at the non-breaching Party's discretion considering the gravity and nature of the default) cure period. Said notice shall be delivered by Certified Mail, Return Receipt Requested, or in person with proof of delivery. Allowing time to cure a failure or breach of contract does not waive the right to immediately terminate the contract for the same or different contract breach which may occur at a different time.

In case of breach by the Contractor, the State may, without unreasonable delay, make a good faith effort to make a reasonable purchase or contract to purchased goods in substitution of those due from the contractor. The State may recover from the Contractor as damages the difference between the costs of covering the breach. Notwithstanding any clause to the contrary, the State may also recover the contract price together with any incidental or consequential damages defined in UCC Section 2-715, but less expenses saved in consequence of Contractor's breach.

The State's failure to make payment shall not be a breach, and the Contractor shall retain all available statutory remedies. (See Indemnity - Self-Insurance and Payment)

I. NON-WAIVER OF BREACH

The acceptance of late performance with or without objection or reservation by a Party shall not waive any rights of the Party nor constitute a waiver of the requirement of timely performance of any obligations remaining to be performed.

J. SEVERABILITY

If any term or condition of the contract is declared by a court of competent jurisdiction to be illegal or in conflict with any law, the validity of the remaining terms and conditions shall not be affected, and the rights and obligations of the parties shall be construed and enforced as if the contract did not contain the provision held to be invalid or illegal.

K. INDEMNIFICATION

1. GENERAL

The Contractor agrees to defend, indemnify, and hold harmless the State and its employees, volunteers, agents, and its elected and appointed officials ("the indemnified parties") from and against any and all claims, liens, demands, damages, liability, actions, causes of action, losses, judgments, costs, and expenses of every nature, including investigation costs and expenses, settlement costs, and attorney fees and expenses ("the claims"), sustained or asserted against the State for personal injury, death, or property loss or damage, arising out of, resulting from, or attributable to the willful misconduct, negligence, error, or omission of the Contractor, its employees, Subcontractors, consultants, representatives, and agents, resulting from this contract, except to the extent such Contractor liability is attenuated by any action of the State which directly and proximately contributed to the claims.

2. SELF-INSURANCE (Statutory)

The State is self-insured for any loss and purchases excess insurance coverage pursuant to Neb. Rev. Stat. § 81-8,239.01 (Reissue 2008). If there is a presumed loss under the provisions of this agreement, Contractor may file a claim with the Office of Risk Management pursuant to Neb. Rev. Stat. §81-8,829 through 81-8,306 for review by the State Claims Board. The State retains all rights and immunities under the State Miscellaneous (Section 81-8,294), Tort (Section 81-8,209), and Contract Claim Acts (Section 81-8,302), as outlined in Neb. Rev. Stat. § 81-8,209 et seq. and under any other provisions of law and accepts liability under this agreement to the extent provided by law.

3. ATTORNEY GENERAL'S AUTHORITY

The Parties acknowledge that Attorney General for the State is required by statute to represent the legal interests of the State, and that any provision of this indemnity clause is subject to the statutory authority of the Attorney General.

L. ATTORNEY'S FEES

In the event of any litigation, appeal, or other legal action to enforce any provision of the contract, the Parties agree to pay all expenses of such action, as permitted by law and if order by the court, including attorney's fees and costs, if the other party prevails.

M. CONTRACTING WITH OTHER POLITICAL SUB-DIVISIONS OF THE STATE OR ANOTHER STATE

The Contractor may, but shall not be required to, allow agencies, as defined in Neb. Rev. Stat. § 81-145, to use this Participating Addendum. The terms and conditions, including price, of the Participating Addendum may not be amended. The State shall not be contractually obligated or liable for any Participating Addendum entered into pursuant to this clause.

The Contractor may, but shall not be required to, allow other states, agencies or divisions of other states, or political subdivisions of other states to use this Participating Addendum. The terms and conditions, including price, of this Participating Addendum shall apply to any such Participating Addendum, but may be amended upon mutual consent of the Parties. The State of Nebraska shall not be contractually or otherwise obligated or liable under any Participating

Addendum entered into pursuant to this clause. The State shall be notified if a Participating Addendum is executed based upon this Participating Addendum.

N. EARLY TERMINATION

The contract may be terminated as follows:

1. The State and the Contractor, by mutual written agreement, may terminate the contract at any time.
2. The State, at its sole discretion, may terminate the contract for any reason upon thirty (30) calendar day's written notice to the Contractor. Such termination shall not relieve the Contractor of warranty or other service obligations incurred under the terms of the contract. In the event of termination the Contractor shall be entitled to payment, determined on a pro rata basis, for products or services satisfactorily performed or provided.
3. The State may terminate the contract immediately for the following reasons:
 - a. if directed to do so by statute;
 - b. Contractor has made an assignment for the benefit of creditors, has admitted in writing its inability to pay debts as they mature, or has ceased operating in the normal course of business;
 - c. a trustee or receiver of the Contractor or of any substantial part of the Contractor's assets has been appointed by a court;
 - d. fraud, misappropriation, embezzlement, malfeasance, misfeasance, or illegal conduct pertaining to performance under the contract by its Contractor, its employees, officers, directors, or shareholders;
 - e. an involuntary proceeding has been commenced by any party against the Contractor under any one of the chapters of Title 11 of the United States Code and (i) the proceeding has been pending for at least sixty (60) calendar days; or (ii) the Contractor has consented, either expressly or by operation of law, to the entry of an order for relief; or (iii) the Contractor has been decreed or adjudged a debtor;
 - f. a voluntary petition has been filed by the Contractor under any of the chapters of Title 11 of the United States Code;
 - g. Contractor intentionally discloses confidential information;
 - h. Contractor has or announces it will discontinue support of the deliverable; and,
 - i. In the event funding is no longer available.

O. PARTICIPATING ADDENDUM CLOSEOUT

Upon termination of the Participating Addendum for any reason the Contractor shall within thirty (30) days, unless stated otherwise herein:

1. Transfer all completed or partially completed deliverables to the State;
2. Transfer ownership and title to all completed or partially completed deliverables to the State;
3. Return to the State all information and data, unless the Contractor is permitted to keep the information or data by Participating Addendum or rule of law. Contractor may retain one copy of any information or data as required to comply with applicable work product documentation standards or as are automatically retained in the course of Contractor's routine back up procedures;
4. Cooperate with any successor contractor, person or entity in the assumption of any or all of the obligations of this Participating Addendum;
5. Cooperate with any successor contractor, person or entity with the transfer of information or data related to this Participating Addendum;
6. Return or vacate any state owned real or personal property.

Nothing in this Section should be construed to require the Contractor to surrender intellectual property, real or person property, or information or data owned by the Contractor for which the State has no legal claim.

II. CONTRACTOR DUTIES

A. INDEPENDENT CONTRACTOR / OBLIGATIONS

It is agreed that the Contractor is an independent contractor and that nothing contained herein is intended or should be construed as creating or establishing a relationship of employment, agency, or a partnership.

The Contractor is solely responsible for fulfilling the Participating Addendum. The Contractor or the Contractor's representative shall be the sole point of contact regarding all contractual matters.

The Contractor shall secure, at its own expense, all personnel required to perform the services under the Participating Addendum. The personnel the Contractor uses to fulfill the Participating Addendum shall have no contractual or other legal relationship with the State; they shall not be considered employees of the State and shall not be entitled to any compensation, rights or benefits from the State, including but not limited to, tenure rights, medical and hospital care, sick and vacation leave, severance pay, or retirement benefits.

By-name personnel commitments made in the Contractor's bid shall not be changed without the prior written approval of the State. Replacement of these personnel, if approved by the State, shall be with personnel of equal or greater ability and qualifications.

The Contractor warrants that all persons assigned to the project shall be employees of the Contractor or a Subcontractor, and shall be fully qualified to perform the work required herein. Personnel employed by the Contractor or a subcontractor to fulfill the terms of the Participating Addendum shall remain under the sole direction and control of the Contractor or the subcontractor respectively.

With respect to its employees, the Contractor agrees to be solely responsible for the following:

1. Any and all pay, benefits, and employment taxes and/or other payroll withholding;
2. Any and all vehicles used by the Contractor's employees, including all insurance required by state law;
3. Damages incurred by Contractor's employees within the scope of their duties under the Participating Addendum;
4. Maintaining Workers' Compensation and health insurance that complies with state and federal law and submitting any reports on such insurance to the extent required by governing law;
5. Determining the hours to be worked and the duties to be performed by the Contractor's employees; and,
6. All claims on behalf of any person arising out of employment or alleged employment (including without limit claims of discrimination alleged against the Contractor, its officers, agents, or subcontractors or subcontractor's employees).

If the Contractor intends to utilize any subcontractor, the Subcontractor's level of effort, tasks, and time allocation must be clearly defined in the Contractor's bid. The Contractor shall agree that it will not utilize any Subcontractors not specifically included in its bid in the performance of the Participating Addendum without the prior written authorization of the State.

The State reserves the right to require the Contractor to reassign or remove from the project any Contractor or Subcontractor employee.

Contractor shall insure that the terms and conditions contained in any Participating Addendum with a sub-contractor does not conflict with the terms and conditions of this Participating Addendum.

The Contractor shall include a similar provision, for the protection of the State, in the Participating Addendum with any Subcontractor engaged to perform work on this Participating Addendum.

B. SECRETARY OF STATE/TAX COMMISSIONER REGISTRATION REQUIREMENTS (Statutory)

All Suppliers must be authorized to transact business in the State and comply with all Nebraska Secretary of State Registration requirements. The Supplier who is the recipient of an Intent to Award will be required to certify that it has complied and produce a true and correct copy of its current (within ninety (90) calendar days of the intent to award) Certificate or Letter of Good Standing, or in the case of a sole proprietorship, provide written documentation of sole proprietorship and the United States Citizenship Attestation Form, available on the DAS website at: <http://das.nebraska.gov/materiel/purchasing.html>. This must be accomplished prior to execution of the Participating Addendum.

C. EMPLOYEE WORK ELIGIBILITY STATUS

The Contractor is required and hereby agrees to use a federal immigration verification system to determine the work eligibility status of employees physically performing work within the State. A federal immigration verification system means the electronic verification of the work authorization program authorized by the Illegal Immigration Reform and Immigrant Responsibility Act of 1996, 8 U.S.C. 1324a, known as the E-Verify Program, or an equivalent federal program designated by the United States Department of Homeland Security or other federal agency authorized to verify the work eligibility status of an employee.

If the Contractor is an individual or sole proprietorship, the following applies:

1. The Contractor must complete the United States Citizenship Attestation Form, available on the DAS website at <http://das.nebraska.gov/materiel/purchasing.html>

The completed United States Attestation Form should be submitted with the ITB response.

2. If the Contractor indicates on such attestation form that he or she is a qualified alien, the Contractor agrees to provide the U.S. Citizenship and Immigration Services documentation required to verify the Contractor's lawful presence in the United States using the Systematic Alien Verification for Entitlements (SAVE) Program.
3. The Contractor understands and agrees that lawful presence in the United States is required and the Contractor may be disqualified or the Participating Addendum terminated if such lawful presence cannot be verified as required by Neb. Rev. Stat. § 4-108.

D. COMPLIANCE WITH CIVIL RIGHTS LAWS AND EQUAL OPPORTUNITY EMPLOYMENT / NONDISCRIMINATION (Statutory)

The Contractor shall comply with all applicable local, state, and federal statutes and regulations regarding civil rights laws and equal opportunity employment. The Nebraska Fair Employment Practice Act prohibits Contractors of the State, and their Subcontractors, from discriminating against any employee or applicant for employment, with respect to hire, tenure, terms, conditions, compensation, or privileges of employment because of race, color, religion, sex, disability, marital status, or national origin (Neb. Rev. Stat. §§ 48-1101 through 48-1125). The Contractor guarantees compliance with the Nebraska Fair Employment Practice Act, and breach of this provision shall be regarded as a material breach of Participating Addendum. The Contractor shall insert a similar provision in all Subcontracts for goods or services to be covered by any Participating Addendum resulting from this ITB.

E. PERMITS, REGULATIONS, LAWS

The Participating Addendum price shall include the cost of all royalties, licenses, permits, and approvals, whether arising from patents, trademarks, copyrights or otherwise, that are in any way involved in the Participating Addendum. The Contractor shall obtain and pay for all royalties, licenses, and permits, and approvals necessary for the performance of the Participating Addendum. The Contractor must guarantee that it has the full legal right to the materials, supplies, equipment, software, and other items used to execute this Participating Addendum.

F. OWNERSHIP OF INFORMATION AND DATA / DELIVERABLES

The State shall have the unlimited right to publish, duplicate, use, and disclose all information and data developed or obtained by the Contractor on behalf of the State pursuant to this Participating Addendum.

The State shall own and hold exclusive title to any deliverable developed as a result of this Participating Addendum. Contractor shall have no ownership interest or title, and shall not patent, license, or copyright, duplicate, transfer, sell, or exchange, the design, specifications, concept, or deliverable.

G. NOTICE OF POTENTIAL CONTRACTOR BREACH

If Contractor breaches the contract or anticipates breaching the contract the Contractor shall immediately give written notice to the State. The notice shall explain the breach or potential breach, and may include a request for a waiver of the breach if so desired. The State may, at its discretion, temporarily or permanently waive the breach. By granting a temporary waiver, the State does not forfeit any rights or remedies to which the State is entitled by law or equity, or pursuant to the provisions of the contract. Failure to give immediate notice, however, may be grounds for denial of any request for a waiver of a breach.

H. ANTITRUST

The Contractor hereby assigns to the State any and all claims for overcharges as to goods and/or services provided in connection with this contract resulting from antitrust violations which arise under antitrust laws of the United States and the antitrust laws of the State.

I. CONFLICT OF INTEREST

By submitting a bid, Contractor certifies that there does not now exist a relationship between the Contractor and any person or entity which is or gives the appearance of a conflict of interest related to this ITB or project.

The Contractor certifies that it shall not take any action or acquire any interest, either directly or indirectly, which will conflict in any manner or degree with the delivery of its goods hereunder or which creates an actual or an appearance of conflict of interest.

The Contractor certifies that it will not employ any individual known by Contractor to have a conflict of interest.

The Parties shall not knowingly, for a period of two years after execution of the contract, recruit or employ any employee or agent of the other Party who has worked on the ITB or project, or who had any influence on decisions affecting the ITB or project.

J. ADVERTISING

The Contractor agrees not to refer to the contract award in advertising in such a manner as to state or imply that the company or its goods are endorsed or preferred by the State. Any publicity releases pertaining to the project shall not be issued without prior written approval from the State.

K. DRUG POLICY

Contractor certifies it maintains a drug free work place environment to ensure worker safety and workplace integrity. Contractor agrees to provide a copy of its drug free workplace policy at any time upon request by the State.

III. PAYMENT

A. PROHIBITION AGAINST ADVANCE PAYMENT

Neb. Rev. Stat. §§ 73-501 through 73-509 states, "... payments shall not be made until contractual deliverable(s) are received and accepted by the State.

B. TAXES

The State is not required to pay taxes and assumes no such liability as a result of this solicitation. The Contractor may request a copy of the Nebraska Department of Revenue, Nebraska Resale or Exempt Sale Certificate for Sales Tax Exemption, Form 13 for their records. Any property tax payable on the Contractor's equipment which may be installed in a state-owned facility is the responsibility of the Contractor.

C. INVOICES

Invoices for payments must be submitted by the Contractor to the agency requesting the services with sufficient detail to support payment. The terms and conditions included in the Contractor's invoice shall be deemed to be solely for the convenience of the parties. No terms or conditions of any such invoice shall be binding upon the State, and no action by the State, including without limitation the payment of any such invoice in whole or in part, shall be construed as binding or estopping the State with respect to any such term or condition, unless the invoice term or condition has been previously agreed to by the State as an amendment to the contract.

D. INSPECTION AND APPROVAL

Final inspection and approval of all work required under the contract shall be performed by the designated State officials.

If a simple inspection of the goods would reveal nonconformity, notice of nonconformity should be provided to the vendor as soon as reasonably practical, but not to exceed thirty (30) days from receipt of goods. This includes visual inspection of product to ensure packaging is not damaged, dented or compromised.

E. PAYMENT (Statutory)

State will render payment to Contractor when the terms and conditions of the contract and specifications have been satisfactorily completed on the part of the Contractor as solely determined by the State. (Neb. Rev. Stat. Section § 73-506(1)). The State may require the Contractor to accept payment by electronic means such as ACH deposit. In no event shall the State be responsible or liable to pay for any services provided by the Contractor prior to the Effective Date of the contract, and the Contractor hereby waives any claim or cause of action for any such services.

F. LATE PAYMENT (Statutory)

The Contractor may charge the responsible agency interest for late payment in compliance with the State of Nebraska Prompt Payment Act (See Neb. Rev. Stat. §§ 81-2401 through 81-2408).

G. SUBJECT TO FUNDING / FUNDING OUT CLAUSE FOR LOSS OF APPROPRIATIONS (Statutory)

The State's obligation to pay amounts due on the Contract for a fiscal years following the current fiscal year is contingent upon legislative appropriation of funds. Should said funds not be appropriated, the State may terminate the contract with respect to those payments for the fiscal year(s) for which such funds are not appropriated. The State will give the Contractor written notice thirty (30) calendar days prior to the effective date of termination. All obligations of the State to make payments after the termination date will cease. The Contractor shall be entitled to receive just and equitable compensation for any authorized work which has been satisfactorily completed as of the termination date. In no event shall the Contractor be paid for a loss of anticipated profit.

H. REPORTS

The Contractor shall also provide to the State of Nebraska primary contact person quarterly utilization reports containing at a minimum the following information pertaining to State of Nebraska Utilization:

- i. Purchase order number;
- ii. Description;
- iii. Quantity; and
- iv. Price.

These reports will be provided in Excel format and sent via email on a quarterly basis as follows:

Period End	Report Due
December 31	January 31
March 31	April 30
June 30	July 31
September 30	October 31

I. ADMINISTRATIVE FEE /REBATE

The Contractor agrees to provide a quarterly administrative fee in the form of a check. The fee will be payable to the State for an amount equal to on-quarter of one percent (0.25% or 0.0025) of the net sales (net of any returns, credits, or adjustments) under this Addendum for the period. The Contractor's WSCA-NASPO/NASPO ValuePoint pricing to the State shall not be adjusted to offset for the equivalent fee amount. Payments shall be made in accordance with following schedule:

Period Ending	Fee Due
December 31	January 31
March 31	April 30
June 30	July 31
September 30	October 31

The Contractor agrees to provide a quarterly utilization report, reflecting new sales to the State during the associated fee period. The report shall be in the format developed by the Lead State and as agreed to by the Contractor. The report will be provided in secure electronic format and/or submitted electronically to the State contact listed in the Addendum

ADMINISTRATIVE FEE/REBATE REMITTANCE LOCATION

All Administrative Fees/Rebates will be sent to the following address:

State Purchasing Bureau
c/o Central Finance, Administrative Services
1526 K Street, Suite 150
Lincoln, NE 68508

VALK MANUFACTURING							
STATE	VERMONT		ESTIMATED	TOTAL	Recycled	Post Consumer	
Item #	DESCRIPTION		QUANTITY		Content	Content	
BLADES							
1	6" top punched 44" carbide blade, 6 hole QUOTING: MFR: Valk Manufacturing Company DELIVERY ARO: 60-120 /DAYS	#	4074	\$143.15	\$583,193.10	90%	
2	6" top punched 44" carbide blade, 5 hole QUOTING: MFR: Valk Manufacturing Company DELIVERY ARO: 60-120 /DAYS	#	1866	\$143.15	\$267,117.90	90%	
3	6" top punched 28" carbide blade, 3 hole QUOTING: MFR: Valk Manufacturing Company DELIVERY ARO: 60-120 /DAYS	#	1300	\$91.09	\$118,417.00	90%	
4	6" top punched 72" carbide blade, 9 hole QUOTING: MFR: Valk Manufacturing Company DELIVERY ARO: 60-120 /DAYS	#	10	\$234.24	\$2,342.40	90%	
6" top punched 20" carbide blade, 3 hole, right or left							
5	Right hand blade QUOTING: MFR: Valk Manufacturing Company DELIVERY ARO: 60-120 /DAYS	#	68	\$65.07	\$4,424.76	90%	
6	Left hand blade QUOTING: MFR: Valk Manufacturing Company DELIVERY ARO: 60-120 /DAYS	#	20	\$65.07	\$1,301.40	90%	
6" top punched 36" carbide blade, 5 hole, right or left							
7	Right hand blade QUOTING: MFR: Valk Manufacturing Company DELIVERY ARO: 60-120 /DAYS	#	68	\$117.12	\$7,964.16	90%	
8	Left hand blade QUOTING: MFR: Valk Manufacturing Company DELIVERY ARO: 60-120 /DAYS	#	20	\$117.12	\$2,342.40	90%	
9	6" top punched 48" carbide grader blade, 6 hole QUOTING: MFR: Valk Manufacturing Company DELIVERY ARO: 60-120 /DAYS	#	15	\$156.16	\$2,342.40	90%	
10	6" top punched 36" carbide blade, 5 holes (12") QUOTING: MFR: Valk Manufacturing Company DELIVERY ARO: 60-120 /DAYS	#	67	\$117.12	\$7,847.04	90%	
11	6" top punched 48" carbide blade, 6 holes (12") QUOTING: MFR: Valk Manufacturing Company DELIVERY ARO: 60-120 /DAYS	#	140	\$156.16	\$21,862.40	90%	
12	6" top punched 84" carbide JD grader blade, 15 hole QUOTING: MFR: Valk Manufacturing Company DELIVERY ARO: 60-120 /DAYS	#	10	\$294.28	\$2,942.80	90%	
13	8" top punched 60" hardened steel blade, 8 hole QUOTING: MFR: # Valk Manufacturing Company DELIVERY ARO: 30-60 /DAYS	#	90	\$99.40	\$8,946.00	90%	
14	8" top punched 72" hardened steel blade, 9 hole QUOTING: MFR: Valk Manufacturing Company DELIVERY ARO: 30-60 /DAYS	#	110	\$119.28	\$13,120.80	90%	
15	8" top punched 60" harden steel blade, 7 hole (12") QUOTING: MFR: Valk Manufacturing Company DELIVERY ARO: 30-60 /DAYS	#	10	\$99.40	\$994.00	90%	
16	8" top punched 72" hardened steel blade, 8 hole (12") QUOTING: MFR: Valk Manufacturing Company DELIVERY ARO: 30-60 /DAYS	#	10	\$119.28	\$1,192.80	90%	
17	8" top punched 84" hardened steel blade, 15 hole QUOTING: MFR: Valk Manufacturing Company DELIVERY ARO: 30-60 /DAYS	#	10	\$139.16	\$1,391.60	90%	
18	8" center punched 11' regular steel blade, 17 hole QUOTING: MFR: Valk Manufacturing Company DELIVERY ARO: 30-60 /DAYS	#	44	\$119.00	\$5,236.00	90%	
19	6" top punched 11' regular steel blade, 17 hole QUOTING: MFR: Valk Manufacturing Company DELIVERY ARO: 30-60 /DAYS	#	170	\$86.50	\$14,705.00	90%	
20	17 hole, 8" TP, 11' plow blade QUOTING: MFR: Valk Manufacturing Company DELIVERY ARO: 30-60 /DAYS	#	80	\$119.00	\$9,520.00	90%	
21	14 hole, 6" TP, 12' plow blade QUOTING: MFR: Valk Manufacturing Company DELIVERY ARO: 30-60 /DAYS	#	10	\$94.40	\$944.00	90%	
22	6" top punched 11' regular steel blade, 13 hole (12") QUOTING: MFR: Valk Manufacturing Company DELIVERY ARO: 30-60 /DAYS	#	10	\$86.50	\$865.00	90%	
23	6" top punched 10' regular steel blade, 12 holes (12") QUOTING: MFR: Valk Manufacturing Company DELIVERY ARO: 30-60 /DAYS	#	10	\$78.70	\$787.00	90%	
24	6" top punched 9' regular steel blade, 11 holes (12") QUOTING: MFR: Valk Manufacturing Company DELIVERY ARO: 30-60 /DAYS	#	10	\$70.80	\$708.00	90%	
25	Wing blade, 15 hole, 6" TP RSWB-15 QUOTING: MFR: Valk Manufacturing Company DELIVERY ARO: 30-60 /DAYS	#	10	\$94.40	\$944.00	90%	
26	8" center punched 9' regular steel blade, 14 hole QUOTING: MFR: Valk Manufacturing Company DELIVERY ARO: 30-60 /DAYS	#	49	\$97.80	\$4,792.20	90%	
27	6" top punched 9' regular steel blade, 14 hole QUOTING: MFR: Valk Manufacturing Company DELIVERY ARO: 30-60 /DAYS	#	60	\$70.80	\$4,248.00	90%	
28	8" top punched 9' regular steel blade, 14 hole QUOTING: MFR: Valk Manufacturing Company	#	10	\$97.80	\$978.00	90%	

	DELIVERY ARO: 30-60 /DAYS					
29	15 hole, 6" TP 10' wing blade	30	\$78.70	\$2,361.00	90%	
	QUOTING: MFR: Valk Manufacturing Company #					
	DELIVERY ARO: 30-60 /DAYS					
30	72" Grader blade section, 6"	10	\$50.00	\$500.00	90%	
	QUOTING: MFR: Valk Manufacturing Company #					
	DELIVERY ARO: 30-60 /DAYS					
31	72" Grader blade section, 8"	10	\$73.00	\$730.00	90%	
	QUOTING: MFR: Valk Manufacturing Company #					
	DELIVERY ARO: 30-60 /DAYS					

32	72" Serrated grader blade section, 6" QUOTING: MFR: Valk Manufacturing Company DELIVERY ARO: 30-60 /DAYS	#	10	\$64.00	\$640.00	90%
33	8" center punched 12' regular steel blade, 18 hole QUOTING: MFR: Valk Manufacturing Company DELIVERY ARO: 30-60 /DAYS	#	10	\$130.00	\$1,300.00	90%
34	11' Cat 120 grader wing, 6" TP QUOTING: MFR: Valk Manufacturing Company DELIVERY ARO: 30-60 /DAYS	#	8	\$86.00	\$688.00	90%
35	John Deere 544E bucket cutting edge QUOTING: MFR: Valk Manufacturing Company DELIVERY ARO: 30-60 /DAYS	#	10	\$377.17	\$3,771.70	90%
36	John Deere 544G & H bucket cutting edge set QUOTING: MFR: Valk Manufacturing Company DELIVERY ARO: 30-60 /DAYS	#	23	\$423.08	\$9,730.84	90%
37	End section only - each QUOTING: MFR: Valk Manufacturing Company DELIVERY ARO: 30-60 /DAYS	#	20	\$80.00	\$1,600.00	90%
38	John Deere 310 & 410 bucket cutting edge QUOTING: MFR: Valk Manufacturing Company DELIVERY ARO: 30-60 /DAYS	#	7	\$293.49	\$2,054.43	90%
39	Craig snow bucket edge QUOTING: MFR: Valk Manufacturing Company DELIVERY ARO: 30-60 /DAYS	#	2	\$474.83	\$949.66	90%
40	7-1/2' Fisher plow blade 6" TP (1/2x6x90) QUOTING: MFR: Valk Manufacturing Company DELIVERY ARO: 30-60 DAYS	#	10	\$56.00	\$560.00	90%
41	6" top punch 8' regular steel blade, 8 hole Fisher Plow QUOTING: MFR: Valk Manufacturing Company DELIVERY ARO: 30-60 DAYS	#	8	\$64.00	\$512.00	90%
42	120" Viking runway plow section 8" CP QUOTING: MFR: Valk Manufacturing Company DELIVERY ARO: 30-60 DAYS	#	10	\$108.00	\$1,080.00	90%
43	40E: 5 holes at 8" center-center starting at 4" from each end, and 2" from top QUOTING: MFR: Valk Manufacturing Company DELIVERY ARO: 60-120 DAYS	#	192	\$130.13	\$24,984.96	90%
44	Section 40C: Carbide Blade for 120" blade. 3/4" x 6" x 40" (20 degrees) QUOTING: MFR: Valk Manufacturing Company DELIVERY ARO: 60-120 DAYS	#	60	\$130.13	\$7,807.80	90%
STATE MASSACHUSSETS						
1	PLOW BLADE 5/8"x 6' x 144" SHP QUOTING: MFR: Valk Manufacturing Company DELIVERY ARO: 30-60 DAYS	#	30	\$104.00	\$3,120.00	90%
2	PLOW BLADE 5/8" x 6' x 168" SHP QUOTING: MFR: Valk Manufacturing Company DELIVERY ARO: 30-60 DAYS	#	30	\$121.00	\$3,630.00	90%
3	PLOW BLADE 1/2" x 6"x 132" SHP QUOTING: MFR: Valk Manufacturing Company DELIVERY ARO: 30-60 DAYS	#	150	\$76.00	\$11,400.00	90%
4	PLOW BLADE 1/2" x 6"x 120" SHP QUOTING: MFR: Valk Manufacturing Company DELIVERY ARO: 30-60 DAYS	#	40	\$69.30	\$2,772.00	90%
5	PLOW BLADE CARBIDE 3/4" x 6" x 3' QUOTING: MFR: Valk Manufacturing Company DELIVERY ARO: 60-120 /DAYS	#	240	\$126.12	\$30,268.80	90%
6	PLOW BLADE CARBIDE 3/4" x 6" x 4' QUOTING: MFR: Valk Manufacturing Company DELIVERY ARO: 60-120 /DAYS	#	510	\$168.16	\$85,761.60	90%
KUEPER TUCA SX CARBIDE TIPPED SNOWPLOW BLADES						
7	3' Sets QUOTING: MFR: # DELIVERY ARO: /DAYS	#	100	NO BID	\$0.00	
8	4' Sets QUOTING: MFR: # DELIVERY ARO: /DAYS	#	200	NO BID	\$0.00	
STATE NEW HAMPSHIRE						
1	Carbide Blade 28C - 3/4" x 6" x 28", 25 Degrees QUOTING: MFR: Valk Manufacturing Company DELIVERY ARO: 90-150 /DAYS	#	209	\$115.10	\$24,055.90	90%
2	Carbide Blade 40C - 3/4" x 6" x 40", 25 Degrees QUOTING: MFR: Valk Manufacturing Company DELIVERY ARO: 90-150 /DAYS	#	60	\$164.43	\$9,865.80	90%
3	Carbide Blade 44C - 3/4" x 6" x 44", 25 Degrees QUOTING: MFR: Valk Manufacturing Company DELIVERY ARO: 90-150 /DAYS	#	458	\$180.88	\$82,843.04	90%
4	Carbide Blade 44E - 3/4" x 6" x 44", 25 Degrees QUOTING: MFR: Valk Manufacturing Company DELIVERY ARO: 90-150 /DAYS	#	905	\$180.88	\$163,696.40	90%
5	Carbide Blade 48", 6" top punched, 6 holes, 12" on center holes, 4 footers QUOTING: MFR: Valk Manufacturing Company DELIVERY ARO: 90-150 /DAYS	#	118	\$197.32	\$23,283.76	90%
6	Carbide Blade 36", 6" top punched, 5 holes, 12" on center holes, 3 footers QUOTING: MFR: Valk Manufacturing Company DELIVERY ARO: 90-150 /DAYS	#	59	\$147.99	\$8,731.41	90%
7	6" top punched 44" carbide blade, 6 hole QUOTING: MFR: Valk Manufacturing Company DELIVERY ARO: 90-150 /DAYS	#	4074	\$180.88	\$736,905.12	90%
8	6" top punched 44" carbide blade, 5 hole QUOTING: MFR: Valk Manufacturing Company DELIVERY ARO: 90-150 /DAYS	#	1866	\$180.88	\$337,522.08	90%

9	6" top punched 28" carbide blade, 3 hole QUOTING: MFR: Valk Manufacturing Company # DELIVERY ARO: 90-150 /DAYS	1300	\$115.10	\$149,630.00	90%
10	6" top punched 72" carbide blade, 9 hole QUOTING: MFR: Valk Manufacturing Company # DELIVERY ARO: 90-150 /DAYS	10	\$295.98	\$2,959.80	90%
	6" top punched 20" carbide blade, 3 hole, right or left				
11	Right hand blade QUOTING: MFR: Valk Manufacturing Company # DELIVERY ARO: 90-150 /DAYS	68	\$82.22	\$5,590.96	90%
12	Left hand blade QUOTING: MFR: Valk Manufacturing Company # DELIVERY ARO: 90-150 /DAYS	20	\$82.22	\$1,644.40	90%
13	6" top punched 48" carbide grader blade, 6 hole QUOTING: MFR: Valk Manufacturing Company # DELIVERY ARO: 90-150 DAYS	15	\$197.32	\$2,959.80	90%
14	6" top punched 36" carbide blade, 5 holes (12") QUOTING: MFR: Valk Manufacturing Company # DELIVERY ARO: 90-150 DAYS	67	\$147.99	\$9,915.33	90%
15	6" top punched 48" carbide blade, 6 holes (12") QUOTING: MFR: Valk Manufacturing Company # DELIVERY ARO: 90-150 DAYS	140	\$197.32	\$27,624.80	90%
16	6" top punched 84" carbide JD grader blade, 15 hole QUOTING: MFR: Valk Manufacturing Company # DELIVERY ARO: 90-150 DAYS	10	\$380.31	\$3,803.10	90%
17	8" top punched 60" hardened steel blade, 8 hole QUOTING: MFR: Valk Manufacturing Company # DELIVERY ARO: 30-60 DAYS	90	\$99.40	\$8,946.00	90%
18	8" top punched 72" hardened steel blade, 9 hole QUOTING: MFR: Valk Manufacturing Company # DELIVERY ARO: 30-60 DAYS	110	\$119.28	\$13,120.80	90%
19	8" top punched 60" harden steel blade, 7 hole (12") QUOTING: MFR: Valk Manufacturing Company # DELIVERY ARO: 30-60 DAYS	10	\$99.40	\$994.00	90%
20	8" top punched 72" hardened steel blade, 8 hole (12") QUOTING: MFR: Valk Manufacturing Company # DELIVERY ARO: 30-60 DAYS	10	\$119.28	\$1,192.80	90%
21	8" top punched 84" hardened steel blade, 15 hole QUOTING: MFR: Valk Manufacturing Company # DELIVERY ARO: 30-60 DAYS	10	\$139.16	\$1,391.60	90%
22	8" center punched 11' regular steel blade, 17 hole QUOTING: MFR: Valk Manufacturing Company # DELIVERY ARO: 30-60 DAYS	44	\$119.00	\$5,236.00	90%
23	6" top punched 11' regular steel blade, 17 hole QUOTING: MFR: Valk Manufacturing Company # DELIVERY ARO: 30-60 DAYS	170	\$86.50	\$14,705.00	90%
24	17 hole, 8" TP, 11' plow blade (5/8x8x132) QUOTING: MFR: Valk Manufacturing Company # DELIVERY ARO: 30-60 DAYS	80	\$119.00	\$9,520.00	90%
25	14 hole, 6" TP, 12' plow blade (5/8x6x144) QUOTING: MFR: Valk Manufacturing Company # DELIVERY ARO: 30-60 DAYS	10	\$94.40	\$944.00	90%
26	6" top punched 11' regular steel blade, 13 hole (12") QUOTING: MFR: Valk Manufacturing Company # DELIVERY ARO: 30-60 DAYS	10	\$86.50	\$865.00	90%
27	6" top punched 10' regular steel blade, 12 holes (12") QUOTING: MFR: Valk Manufacturing Company # DELIVERY ARO: 30-60 DAYS	10	\$78.70	\$787.00	90%
28	6" top punched 9' regular steel blade, 11 holes (12") QUOTING: MFR: Valk Manufacturing Company # DELIVERY ARO: 30-60 DAYS	10	\$70.80	\$708.00	90%
29	Wing blade, 15 hole, 6" TP RSWB-15 QUOTING: MFR: Valk Manufacturing Company # DELIVERY ARO: 30-60 DAYS	10	\$94.40	\$944.00	90%
30	8" center punched 9' regular steel blade, 14 hole QUOTING: MFR: Valk Manufacturing Company # DELIVERY ARO: 30-60 DAYS	49	\$97.80	\$4,792.20	90%
31	6" top punched 9' regular steel blade, 14 hole QUOTING: MFR: Valk Manufacturing Company # DELIVERY ARO: 30-60 DAYS	60	\$70.80	\$4,248.00	90%
32	8" top punched 9' regular steel blade, 14 hole QUOTING: MFR: Valk Manufacturing Company # DELIVERY ARO: 30-60 DAYS	10	\$97.80	\$978.00	90%
33	15 hole, 6" TP 10' wing blade QUOTING: MFR: Valk Manufacturing Company # DELIVERY ARO: 30-60 DAYS	30	\$78.70	\$2,361.00	90%
34	72" Grader blade section, 6" QUOTING: MFR: Valk Manufacturing Company # DELIVERY ARO: 30-60 DAYS	10	\$50.00	\$500.00	90%
35	72" Grader blade section, 8" QUOTING: MFR: Valk Manufacturing Company # DELIVERY ARO: 30-60 DAYS	10	\$73.00	\$730.00	90%
36	72" Serrated grader blade section, 6" QUOTING: MFR: Valk Manufacturing Company # DELIVERY ARO: 30-60 DAYS	10	\$64.00	\$640.00	90%
37	8" center punched 12' regular steel blade, 18 hole QUOTING: MFR: Valk Manufacturing Company # DELIVERY ARO: 30-60 DAYS	10	\$130.00	\$1,300.00	90%
38	11' Cat 120 grader wing, 6" TP QUOTING: MFR: Valk Manufacturing Company # DELIVERY ARO: 30-60 DAYS	8	\$86.00	\$688.00	90%

39	John Deere 544E bucket cutting edge QUOTING: MFR: Valk Manufacturing Company # DELIVERY ARO: 30-60 DAYS	10	\$377.17	\$3,771.70	90%
40	John Deere 544G & H bucket cutting edge set QUOTING: MFR: Valk Manufacturing Company # DELIVERY ARO: 30-60 DAYS	23	\$423.08	\$9,730.84	90%
41	End section only - each QUOTING: MFR: Valk Manufacturing Company # DELIVERY ARO: 30-60 DAYS	20	\$80.00	\$1,600.00	90%
42	John Deere 310 & 410 bucket cutting edge QUOTING: MFR: Valk Manufacturing Company # DELIVERY ARO: 30-60 DAYS	7	\$293.49	\$2,054.43	90%
43	Craig snow bucket edge QUOTING: MFR: Valk Manufacturing Company # DELIVERY ARO: 30-60 DAYS	2	\$474.83	\$949.66	90%
44	7-1/2' Fisher plow blade 6" TP QUOTING: MFR: Valk Manufacturing Company # DELIVERY ARO: 30-60 DAYS	10	\$56.00	\$560.00	90%
45	6" top punch 8' regular steel blade, 8 hole Fisher Plow QUOTING: MFR: Valk Manufacturing Company # DELIVERY ARO: 30-60 DAYS	8	\$64.00	\$512.00	90%
46	120" Viking runway plow section 8" CP QUOTING: MFR: Valk Manufacturing Company # DELIVERY ARO: 30-60 DAYS	10	\$108.00	\$1,080.00	90%
46	40E: 5 holes at 8" center-center starting at 4" from each end, and 2" from top QUOTING: MFR: Valk Manufacturing Company # DELIVERY ARO: 90-150 DAYS	192	\$164.43	\$31,570.56	90%
48	Section 40C: Carbide Blade for 120" blade. 3/4" x 6" x 40" (20 degrees) QUOTING: MFR: Valk Manufacturing Company # DELIVERY ARO: 90-150 DAYS	60	\$164.43	\$9,865.80	90%
Joma flexible plow blades & setup kits					
49	Reversible plows - 10' JOMA front plow setup (with adaptor blades punched 8" O/C QUOTING: MFR: # DELIVERY ARO: /DAYS		NO BID	\$0.00	
50	Reversible plows - 11' JOMA front plow setup (with adaptor blades punched 8" O/C QUOTING: MFR: # DELIVERY ARO: /DAYS	4074	NO BID	\$0.00	
51	3' replacement blades for JOMA part #JM20315 - 3' Section - 7/8" x 6" x 36" QUOTING: MFR: # DELIVERY ARO: /DAYS	1866	NO BID	\$0.00	
52	4' replacement blades for JOMA part #JM20415 - 4' Section - 7/8" x 6" x 48" QUOTING: MFR: # DELIVERY ARO: /DAYS	1300	NO BID	\$0.00	
Nut & Bolt Kits for Plow Blades					
53	10' (all nuts & bolts for setup) #KTJM 501 QUOTING: MFR: # DELIVERY ARO: /DAYS	68	NO BID	\$0.00	
54	11' (all nuts & bolts for setup) #KTJM502 QUOTING: MFR: # DELIVERY ARO: /DAYS	20	NO BID	\$0.00	
55	12' (all nuts & bolts for setup) #KTJM500 QUOTING: MFR: # DELIVERY ARO: /DAYS	15	NO BID	\$0.00	
Curb runners & nose piece)					
56	Part # CR6312FL - Left Curb Runner QUOTING: MFR: # DELIVERY ARO: /DAYS	140	NO BID	\$0.00	
57	Part #CR6312FR - Right Curb Runner QUOTING: MFR: # DELIVERY ARO: /DAYS	10	NO BID	\$0.00	
58	BLADE-SLUSH CARB 4' QUOTING: MFR: Valk Manufacturing Company # DELIVERY ARO: 90-150 /DAYS	90	\$197.32	\$17,758.80	90%
59	BLADE-SLUSH CARB 3' QUOTING: MFR: Valk Manufacturing Company # DELIVERY ARO: 90-150 /DAYS	110	\$147.99	\$16,278.90	90%
60	BLADE-PLOW CARB 3' QUOTING: MFR: Valk Manufacturing Company # DELIVERY ARO: 90-150 /DAYS	10	\$147.99	\$1,479.90	90%
61	BLADE-PLOW CARB 4' QUOTING: MFR: Valk Manufacturing Company # DELIVERY ARO: 90-150 /DAYS	10	\$197.32	\$1,973.20	90%
62	BLADE-GRADER 6'; Std. Curved; 3-3-12 punch QUOTING: MFR: Valk Manufacturing Company # DELIVERY ARO: 30-60 DAYS	10	\$50.00	\$500.00	90%
63	BLADE-GRADER SAWTOOTH 6' QUOTING: MFR: Valk Manufacturing Company # DELIVERY ARO: 30-60 DAYS	44	\$64.00	\$2,816.00	90%
64	BLADE-WING 10' 3-3-12 104 AP QUOTING: MFR: Valk Manufacturing Company # DELIVERY ARO: 30-60 DAYS	170	\$62.80	\$10,676.00	90%
65	BLADE-WING 11' 3-3-12 102 AP QUOTING: MFR: Valk Manufacturing Company # DELIVERY ARO: 30-60 DAYS	80	\$69.08	\$5,526.40	90%
66	BLADE-WING 13' 3-3-12 115 AP QUOTING: MFR: Valk Manufacturing Company # DELIVERY ARO: 30-60 DAYS	10	\$81.64	\$816.40	90%
67	BLADE-BUCKET LG CASE 621/621B #L127366 QUOTING: MFR: Valk Manufacturing Company # DELIVERY ARO: 30-60 DAYS	10	\$212.69	\$2,126.90	90%

68	BLADE-BUCKET SM CASE 621/621B #L127367	10	\$189.25	\$1,892.50	90%
	QUOTING: MFR: Valk Manufacturing Company #				
	DELIVERY ARO: 30-60 DAYS				
69	BLADE-WING EVEREST 1/2X6X9' 3-3-12 107AP	10	\$56.50	\$565.00	90%
	QUOTING: MFR: Valk Manufacturing Company #				
	DELIVERY ARO: 30-60 DAYS				
70	BLADE-WING 12JD GRADER 3-3-12 113AP	10	\$75.30	\$753.00	90%
	QUOTING: MFR: Valk Manufacturing Company #				
	DELIVERY ARO: 30-60 DAYS				
71	BLADE-BUCKET CASE 580L/SL 10H #112946A1	49	\$179.69	\$8,804.81	90%
	QUOTING: MFR: Valk Manufacturing Company #				
	DELIVERY ARO: 30-60 DAYS				
72	BLADE-BUCKET CASE 580SM #185506A1	60	\$174.21	\$10,452.60	90%
	QUOTING: MFR: Valk Manufacturing Company #				
	DELIVERY ARO: 30-60 DAYS				
73	John Deere Loader 444 Ends T146673	10	\$80.00	\$800.00	90%
	QUOTING: MFR: Valk Manufacturing Company #				
	DELIVERY ARO: 30-60 DAYS				
74	John Deere Loader 444 Centers T157311	30	\$198.03	\$5,940.90	90%
	QUOTING: MFR: Valk Manufacturing Company #				
	DELIVERY ARO: 30-60 DAYS				
75	Noram Grader 65E	10	NO BID	\$0.00	
	QUOTING: MFR: #				
	DELIVERY ARO: /DAYS				
76	Blade V-Plow Grader 5.5 FT	10	NO BID	\$0.00	
	QUOTING: MFR: #				
	DELIVERY ARO: /DAYS				
STATE MAINE					
1	Carbide Blade 28C - 3/4" x 6" x 28", 25 Degrees	209	\$91.09	\$19,037.81	90%
	QUOTING: MFR: Valk Manufacturing Company #				
	DELIVERY ARO: 60-120 /DAYS				
2	Carbide Blade 40C - 3/4" x 6" x 40", 25 Degrees	60	\$130.13	\$7,807.80	90%
	QUOTING: MFR: Valk Manufacturing Company #				
	DELIVERY ARO: 60-120 /DAYS				
3	Carbide Blade 44C - 3/4" x 6" x 44", 25 Degrees	458	\$143.15	\$65,562.70	90%
	QUOTING: MFR: Valk Manufacturing Company #				
	DELIVERY ARO: 60-120 /DAYS				
4	Carbide Blade 44E - 3/4" x 6" x 44", 25 Degrees	905	\$143.15	\$129,550.75	90%
	QUOTING: MFR: Valk Manufacturing Company #				
	DELIVERY ARO: 60-120 /DAYS				
5	Carbide Blade 48", 6" top punched, 6 holes, 12" on center holes, 4 footers	118	\$156.16	\$18,426.88	90%
	QUOTING: MFR: Valk Manufacturing Company #				
	DELIVERY ARO: 60-120 /DAYS				
6	Carbide Blade 36", 6" top punched, 5 holes, 12" on center holes, 3 footers	59	\$117.12	\$6,910.08	90%
	QUOTING: MFR: Valk Manufacturing Company #				
	DELIVERY ARO: 60-120 /DAYS				
7	6" top punched 44" carbide blade, 6 hole	4074	\$143.15	\$583,193.10	90%
	QUOTING: MFR: Valk Manufacturing Company #				
	DELIVERY ARO: 60-120 /DAYS				
8	6" top punched 44" carbide blade, 5 hole	1866	\$143.15	\$267,117.90	90%
	QUOTING: MFR: Valk Manufacturing Company #				
	DELIVERY ARO: 60-120 /DAYS				
9	6" top punched 28" carbide blade, 3 hole	1300	\$91.09	\$118,417.00	90%
	QUOTING: MFR: Valk Manufacturing Company #				
	DELIVERY ARO: 60-120 /DAYS				
10	6" top punched 72" carbide blade, 9 hole	10	\$294.28	\$2,942.80	90%
	QUOTING: MFR: Valk Manufacturing Company #				
	DELIVERY ARO: 60-120 /DAYS				
6" top punched 20" carbide blade, 3 hole, right or left					
11	Right hand blade	68	\$65.07	\$4,424.76	90%
	QUOTING: MFR: Valk Manufacturing Company #				
	DELIVERY ARO: 60-120 /DAYS				
12	Left hand blade	20	\$65.07	\$1,301.40	90%
	QUOTING: MFR: Valk Manufacturing Company #				
	DELIVERY ARO: 60-120 /DAYS				
13	6" top punched 48" carbide grader blade, 6 hole	15	\$156.16	\$2,342.40	90%
	QUOTING: MFR: Valk Manufacturing Company #				
	DELIVERY ARO: 60-120 /DAYS				
14	6" top punched 36" carbide blade, 5 holes (12")	67	\$117.12	\$7,847.04	90%
	QUOTING: MFR: Valk Manufacturing Company #				
	DELIVERY ARO: 60-120 /DAYS				
15	6" top punched 48" carbide blade, 6 holes (12")	140	\$156.16	\$21,862.40	90%
	QUOTING: MFR: Valk Manufacturing Company #				
	DELIVERY ARO: 60-120 /DAYS				
16	6" top punched 84" carbide JD grader blade, 15 hole	10	\$294.28	\$2,942.80	90%
	QUOTING: MFR: Valk Manufacturing Company #				
	DELIVERY ARO: 60-120 /DAYS				
17	8" top punched 60" hardened steel blade, 8 hole	90	\$99.40	\$8,946.00	90%
	QUOTING: MFR: Valk Manufacturing Company #				
	DELIVERY ARO: 30-60 DAYS				
18	8" top punched 72" hardened steel blade, 9 hole	110	\$119.28	\$13,120.80	90%
	QUOTING: MFR: Valk Manufacturing Company #				
	DELIVERY ARO: 30-60 DAYS				
19	8" top punched 60" harden steel blade, 7 hole (12")	10	\$99.40	\$994.00	90%
	QUOTING: MFR: Valk Manufacturing Company #				
	DELIVERY ARO: 30-60 DAYS				
20	8" top punched 72" hardened steel blade, 8 hole (12")	10	\$119.28	\$1,192.80	90%
	QUOTING: MFR: Valk Manufacturing Company #				
	DELIVERY ARO: 30-60 DAYS				
21	8" top punched 84" hardened steel blade, 15 hole	10	\$139.16	\$1,391.60	90%

	QUOTING: MFR: Valk Manufacturing Company	#				
	DELIVERY ARO: 30-60 DAYS					
22	8" center punched 11' regular steel blade, 17 hole	44	\$119.00	\$5,236.00		90%
	QUOTING: MFR: Valk Manufacturing Company	#				
	DELIVERY ARO: 30-60 DAYS					
23	6" top punched 11' regular steel blade, 17 hole	170	\$86.50	\$14,705.00		90%
	QUOTING: MFR: Valk Manufacturing Company	#				
	DELIVERY ARO: 30-60 DAYS					
24	17 hole, 8" TP, 11' plow blade	80	\$119.00	\$9,520.00		90%
	QUOTING: MFR: Valk Manufacturing Company	#				
	DELIVERY ARO: 30-60 DAYS					
25	14 hole, 6" TP, 12' plow blade	10	\$94.40	\$944.00		90%
	QUOTING: MFR: Valk Manufacturing Company	#				
	DELIVERY ARO: 30-60 DAYS					
26	6" top punched 11' regular steel blade, 13 hole (12")	10	\$86.50	\$865.00		90%
	QUOTING: MFR: Valk Manufacturing Company	#				
	DELIVERY ARO: 30-60 DAYS					
27	6" top punched 10' regular steel blade, 12 holes (12")	10	\$78.70	\$787.00		90%
	QUOTING: MFR: Valk Manufacturing Company	#				
	DELIVERY ARO: 30-60 DAYS					
28	6" top punched 9' regular steel blade, 11 holes (12")	10	\$70.80	\$708.00		90%
	QUOTING: MFR: Valk Manufacturing Company	#				
	DELIVERY ARO: 30-60 DAYS					
29	Wing blade, 15 hole, 6" TP RSWB-15	10	\$94.40	\$944.00		90%
	QUOTING: MFR: Valk Manufacturing Company	#				
	DELIVERY ARO: 30-60 DAYS					
30	8" center punched 9' regular steel blade, 14 hole	49	\$97.80	\$4,792.20		90%
	QUOTING: MFR: Valk Manufacturing Company	#				
	DELIVERY ARO: 30-60 DAYS					
31	6" top punched 9' regular steel blade, 14 hole	60	\$70.80	\$4,248.00		90%
	QUOTING: MFR: Valk Manufacturing Company	#				
	DELIVERY ARO: 30-60 DAYS					
32	8" top punched 9' regular steel blade, 14 hole	10	\$97.80	\$978.00		90%
	QUOTING: MFR: Valk Manufacturing Company	#				
	DELIVERY ARO: 30-60 DAYS					
33	15 hole, 6" TP 10' wing blade	30	\$78.70	\$2,361.00		90%
	QUOTING: MFR: Valk Manufacturing Company	#				
	DELIVERY ARO: 30-60 DAYS					
34	72" Grader blade section, 6"	10	\$50.00	\$500.00		90%
	QUOTING: MFR: Valk Manufacturing Company	#				
	DELIVERY ARO: 30-60 DAYS					
35	72" Grader blade section, 8"	10	\$73.00	\$730.00		90%
	QUOTING: MFR: Valk Manufacturing Company	#				
	DELIVERY ARO: 30-60 DAYS					
36	72" Serrated grader blade section, 6"	10	\$64.00	\$640.00		90%
	QUOTING: MFR: Valk Manufacturing Company	#				
	DELIVERY ARO: 30-60 DAYS					
37	8" center punched 12' regular steel blade, 18 hole	10	\$130.00	\$1,300.00		90%
	QUOTING: MFR: Valk Manufacturing Company	#				
	DELIVERY ARO: 30-60 DAYS					
38	11' Cat 120 grader wing, 6" TP	8	\$86.00	\$688.00		90%
	QUOTING: MFR: Valk Manufacturing Company	#				
	DELIVERY ARO: 30-60 DAYS					
39	John Deere 544E bucket cutting edge	10	\$377.17	\$3,771.70		90%
	QUOTING: MFR: Valk Manufacturing Company	#				
	DELIVERY ARO: 30-60 DAYS					
40	John Deere 544G & H bucket cutting edge set	23	\$423.08	\$9,730.84		90%
	QUOTING: MFR: Valk Manufacturing Company	#				
	DELIVERY ARO: 30-60 DAYS					
41	End section only - each	20	\$80.00	\$1,600.00		90%
	QUOTING: MFR: Valk Manufacturing Company	#				
	DELIVERY ARO: 30-60 DAYS					
42	John Deere 310 & 410 bucket cutting edge	7	\$293.49	\$2,054.43		90%
	QUOTING: MFR: Valk Manufacturing Company	#				
	DELIVERY ARO: 30-60 DAYS					
43	Craig snow bucket edge	2	\$474.83	\$949.66		90%
	QUOTING: MFR: Valk Manufacturing Company	#				
	DELIVERY ARO: 30-60 DAYS					
44	7-1/2' Fisher plow blade 6" TP	10	\$56.00	\$560.00		90%
	QUOTING: MFR: Valk Manufacturing Company	#				
	DELIVERY ARO: 30-60 /DAYS					
45	6" top punch 8' regular steel blade, 8 hole Fisher Plow	8	\$64.00	\$512.00		90%
	QUOTING: MFR: Valk Manufacturing Company	#				
	DELIVERY ARO: 30-60 /DAYS					
46	120" Viking runway plow section 8" CP	10	\$108.00	\$1,080.00		90%
	QUOTING: MFR: Valk Manufacturing Company	#				
	DELIVERY ARO: 30-60 DAYS					
46	40E: 5 holes at 8" center-center starting at 4" from each end, and 2" from top	192	\$130.13	\$24,984.96		90%
	QUOTING: MFR: Valk Manufacturing Company	#				
	DELIVERY ARO: 30-60 DAYS					
48	Section 40C: Carbide Blade for 120" blade. 3/4" x 6" x 40" (20 degrees)	60	\$130.13	\$7,807.80		
	QUOTING: MFR:	#				
	DELIVERY ARO: 60-120 /DAYS					
Joma flexible plow blades & setup kits						
49	Reversible plows - 10' JOMA front plow setup (with adaptor blades punched 8" O/C)		NO BID	\$0.00		
	QUOTING: MFR:	#				
	DELIVERY ARO: /DAYS					
50	Reversible plows - 11' JOMA front plow setup (with adaptor blades punched 8" O/C)	4074	NO BID	\$0.00		
	QUOTING: MFR:	#				
	DELIVERY ARO: /DAYS					
51	3' replacement blades for JOMA part #JM20315 - 3' Section - 7/8" x 6" x 36"	1866	NO BID	\$0.00		

	QUOTING: MFR: _____ # _____				
	DELIVERY ARO: _____/DAYS				
52	4' replacement blades for JOMA part #JM20415 - 4' Section - 7/8" x 6" x 48"	1300	NO BID	\$0.00	
	QUOTING: MFR: _____ # _____				
	DELIVERY ARO: _____/DAYS				
	Nut & Bolt Kits for Plow Blades	10	NO BID	\$0.00	
53	10' (all nuts & bolts for setup) #KTJM 501		NO BID	\$0.00	
	QUOTING: MFR: _____ # _____				
	DELIVERY ARO: _____/DAYS				
		68	NO BID	\$0.00	
54	11' (all nuts & bolts for setup) #KTJM502	20	NO BID	\$0.00	
	QUOTING: MFR: _____ # _____				
	DELIVERY ARO: _____/DAYS				
		15	NO BID	\$0.00	
55	12' (all nuts & bolts for setup) #KTJM500				
	QUOTING: MFR: _____ # _____				
	DELIVERY ARO: _____/DAYS				
	Curb runners & nose piece)	67	NO BID	\$0.00	
56	Part # CR6312FL - Left Curb Runner	140	NO BID	\$0.00	
	QUOTING: MFR: _____ # _____				
	DELIVERY ARO: _____/DAYS				
57	Part #CR6312FR - Right Curb Runner	10	NO BID	\$0.00	
	QUOTING: MFR: _____ # _____				
	DELIVERY ARO: _____/DAYS				
58	BLADE-SLUSH CARB 4' Valk Manufacturing Company	90	\$156.16	\$14,054.40	90%
	DELIVERY ARO: 60-120 /DAYS				
59	BLADE-SLUSH CARB 3' Valk Manufacturing Company	110	\$117.12	\$12,883.20	90%
	DELIVERY ARO: 60-120 /DAYS				
60	BLADE-PLOW CARB 3' Valk Manufacturing Company	10	\$117.12	\$1,171.20	90%
	DELIVERY ARO: 60-120 /DAYS				
61	BLADE-PLOW CARB 4' Valk Manufacturing Company	10	\$156.16	\$1,561.60	90%
	QUOTING: MFR: _____ # _____				
	DELIVERY ARO: 60-120 /DAYS				
62	BLADE-GRADER 6'; Std. Curved; 3-3-12 punch Valk Manufacturing Company	10	\$50.00	\$500.00	90%
	QUOTING: MFR: _____ # _____				
	DELIVERY ARO: 30-60 /DAYS				
63	BLADE-GRADER SAWTOOTH 6' Valk Manufacturing Company	44	\$64.00	\$2,816.00	90%
	QUOTING: MFR: _____ # _____				
	DELIVERY ARO: 30-60 /DAYS				
64	BLADE-WING 10' 3-3-12 104 AP Valk Manufacturing Company	170	\$62.80	\$10,676.00	90%
	QUOTING: MFR: _____ # _____				
	DELIVERY ARO: 30-60 /DAYS				
65	BLADE-WING 11' 3-3-12 102 AP Valk Manufacturing Company	80	\$69.08	\$5,526.40	90%
	QUOTING: MFR: _____ # _____				
	DELIVERY ARO: 30-60 /DAYS				
66	BLADE-WING 13' 3-3-12 115 AP Valk Manufacturing Company	10	\$81.64	\$816.40	90%
	QUOTING: MFR: _____ # _____				
	DELIVERY ARO: 30-60 /DAYS				
67	BLADE-BUCKET LG CASE 621/621B #L127366 Valk Manufacturing Company	10	\$212.69	\$2,126.90	90%
	QUOTING: MFR: _____ # _____				
	DELIVERY ARO: 30-60 /DAYS				
68	BLADE-BUCKET SM CASE 621/621B #L127367 Valk Manufacturing Company	10	\$189.25	\$1,892.50	90%
	QUOTING: MFR: _____ # _____				
	DELIVERY ARO: 30-60 /DAYS				
69	BLADE-WING EVEREST 1/2X6X9' 3-3-12 107AP Valk Manufacturing Company	10	\$56.50	\$565.00	90%
	QUOTING: MFR: _____ # _____				
	DELIVERY ARO: 30-60 /DAYS				
70	BLADE-WING 12'JD GRADER 3-3-12 113AP Valk Manufacturing Company	10	\$75.30	\$753.00	90%
	QUOTING: MFR: _____ # _____				
	DELIVERY ARO: 30-60 /DAYS				
71	BLADE-BUCKET CASE 580L/SL 10H #112946A1 Valk Manufacturing Company	49	\$179.69	\$8,804.81	90%
	QUOTING: MFR: _____ # _____				
	DELIVERY ARO: 30-60 /DAYS				
72	BLADE-BUCKET CASE 580SM #185506A1 Valk Manufacturing Company	60	\$174.21	\$10,452.60	90%
	QUOTING: MFR: _____ # _____				
	DELIVERY ARO: 30-60 /DAYS				
73	John Deere Loader 444 Ends T146673 Valk Manufacturing Company	10	\$80.00	\$800.00	90%
	QUOTING: MFR: _____ # _____				
	DELIVERY ARO: 30-60 /DAYS				
74	John Deere Loader 444 Centers T157311 Valk Manufacturing Company	30	\$198.03	\$5,940.90	90%
	QUOTING: MFR: _____ # _____				
	DELIVERY ARO: 30-60 /DAYS				
75	Noram Grader 65E Valk Manufacturing Company	10	NO BID	\$0.00	90%
	QUOTING: MFR: _____ # _____				
	DELIVERY ARO: _____/DAYS				
76	Blade V-Plow Grader 5.5 FT Valk Manufacturing Company	10	NO BID	\$0.00	90%
	QUOTING: MFR: _____ # _____				
	DELIVERY ARO: _____/DAYS				
STATE CONNECTICUT					
1	Top Punch, 11' - 312-02-0045 Valk Manufacturing Company	2190	\$95.44	\$209,013.60	90%
	QUOTING: MFR: _____ # _____				
	DELIVERY ARO: 30-60 /DAYS				
2	Top Punch, 11', AASHTO, (f/Viking Bottom Trip Plow) 312-02-0097 Valk Manufacturing Company	211	\$95.44	\$20,137.84	90%
	QUOTING: MFR: _____ # _____				
	DELIVERY ARO: 30-60 /DAYS				
3	Top Punch, 11', (f/newer front mount wing plow) Valk Manufacturing Company	310	\$119.20	\$36,952.00	90%
	QUOTING: MFR: _____ # _____				

	DELIVERY ARO: 30-60 /DAYS					
4	Top Punch, 10', (f/mid mount retro fit plow) QUOTING: MFR: Valk Manufacturing Company # DELIVERY ARO: 30-60 /DAYS	199	\$108.00	\$21,492.00	90%	
5	Hardened (sets) – 312-02-0050 QUOTING: MFR: Valk Manufacturing Company # DELIVERY ARO: 30-60 /DAYS	824	\$170.00	\$140,080.00	90%	
6	Blade 8' (Fisher Plow)- 312-02-0065 QUOTING: MFR: Valk Manufacturing Company # DELIVERY ARO: 30-60 /DAYS	16	\$64.00	\$1,024.00	90%	
7	Grader 6' (saw) – 312-02-0008 QUOTING: MFR: Valk Manufacturing Company # DELIVERY ARO: 30-60 /DAYS	16	\$64.00	\$1,024.00	90%	
8	Payloader (John Deere 444 & D) – 312-02-0053 QUOTING: MFR: Valk Manufacturing Company # DELIVERY ARO: 30-60 DAYS	14	\$117.00	\$1,638.00	90%	
9	Payloader (John Deere 544E & G) – 312-02-0073 QUOTING: MFR: Valk Manufacturing Company # DELIVERY ARO: 30-60 DAYS	8	\$263.00	\$2,104.00	90%	
10	Payloader (John Deere 444H) One piece 312-02-0084 QUOTING: MFR: Valk Manufacturing Company # DELIVERY ARO: 30-60 DAYS	16	\$263.00	\$4,208.00	90%	
11	Outside piece – (f/02 Volvo & Cat also) 312-02-0091 QUOTING: MFR: Valk Manufacturing Company # DELIVERY ARO: 30-60 DAYS	83	\$45.00	\$3,735.00	90%	
12	Center piece – JD Bucket Only 312-02-0092 QUOTING: MFR: Valk Manufacturing Company # DELIVERY ARO: 30-60 DAYS	33	\$109.00	\$3,597.00	90%	
13	Payloader (VME Model L70C – Center Piece, Volvo Bucket) 312-02-0077 QUOTING: MFR: Valk Manufacturing Company # DELIVERY ARO: 30-60 DAYS	19	\$180.00	\$3,420.00	90%	
14	Payloader (VME Model L70C – End Piece, Volvo Bucket) 312-02-0078 QUOTING: MFR: Valk Manufacturing Company # DELIVERY ARO: 30-60 DAYS	19	\$88.00	\$1,672.00	90%	
15	Payloader (Multi-piece, f/02 Volvo or Cat loader with JRB Bucket, Center piece) 312-02-0101 QUOTING: MFR: Valk Manufacturing Company # DELIVERY ARO: 30-60 DAYS	39	\$116.00	\$4,524.00	90%	
16	Backhoe (John Deere 310C) -312-02-0074 QUOTING: MFR: Valk Manufacturing Company # DELIVERY ARO: 30-60 DAYS	42	\$158.03	\$6,637.26	90%	
17	Backhoe (John Deere 710D) -312-02-0075 QUOTING: MFR: Valk Manufacturing Company # DELIVERY ARO: 30-60 DAYS	2	\$201.43	\$402.86	90%	
18	Backhoe (Volvo BL70) - QUOTING: MFR: Valk Manufacturing Company # DELIVERY ARO: 30-60 DAYS	4	\$228.43	\$913.72	90%	
19	Bobcat Compact Loader T300 QUOTING: MFR: Valk Manufacturing Company # DELIVERY ARO: 30-60 DAYS	16	\$150.00	\$2,400.00	90%	
20	Bobcat Compact Loader T110 QUOTING: MFR: Valk Manufacturing Company # DELIVERY ARO: 30-60 DAYS	10	\$150.00	\$1,500.00	90%	
			ESTIMATED UNIT PRICE	TOTAL	Recycled Content	Post Consumer Content
STATE	UTAH		QUANTITY			
1	4' Tungsten Carbide Insert Rigid Blade QUOTING: MFR: Valk Manufacturing Company # DELIVERY ARO: 90-150 /DAYS	2350	\$219.28	\$515,308.00	90%	
2	4' Articulated Tungsten Carbide Blades QUOTING: MFR: Valk Manufacturing Company # DELIVERY ARO: 90-150 /DAYS	920	\$41.46	\$38,143.20	90%	
3	4' Plain steel cover blades QUOTING: MFR: Valk Manufacturing Company # DELIVERY ARO: 90-150 /DAYS	1200	\$62.19	\$74,628.00	90%	
STATE	COLORADO					
1	BLADE, BUL NSE, 3/4X8X7",5/8" HOLES,STRT QUOTING: MFR: Valk Manufacturing Company # DELIVERY ARO: 30-60 /DAYS	74	\$112.00	\$8,288.00	90%	
2	BLADE, GRADER CURVE 1"x 8" x 7' QUOTING: MFR: Valk Manufacturing Company # DELIVERY ARO: 30-60 /DAYS	26	\$150.00	\$3,900.00	90%	
3	BLADE, GRADER CURVE 3/4"x8"x7' QUOTING: MFR: Valk Manufacturing Company # DELIVERY ARO: 30-60 /DAYS	102	\$112.00	\$11,424.00	90%	
4	BLADE, GRADER CURVE 5/8"x8"x6' QUOTING: MFR: Valk Manufacturing Company # DELIVERY ARO: 30-60 /DAYS	10	\$80.00	\$800.00	90%	
5	BLADE, GRADER CURVED, 3/4"x7' 3/4" HOLE QUOTING: MFR: Valk Manufacturing Company # DELIVERY ARO: 30-60 /DAYS	79	\$112.00	\$8,848.00	90%	
6	BLADE, GRDR CRVD 5/8"x8"x7",5/8"BLT HOLE QUOTING: MFR: Valk Manufacturing Company # DELIVERY ARO: 30-60 /DAYS	374	\$93.30	\$34,894.20	90%	
7	BLADE, GRDR-LDR FLAT 3/4"x 8"x 6' 4T3007 QUOTING: MFR: Valk Manufacturing Company # DELIVERY ARO: 30-60 /DAYS	6	\$96.00	\$576.00	90%	

8	BLADE, LDR BKT,644J,4PC/BLTS,T167828/829	15	NO BID	\$0.00		90%
	QUOTING: MFR: #					
	DELIVERY ARO: /DAYS					
9	BLADE, LDRBKT,L110E,3PC/BLT,11045809/08	2	NO BID	\$0.00		90%
	QUOTING: MFR: #					
	DELIVERY ARO: /DAYS					
10	BLADE, LDRBKT,L150,3PC/BLTS,11082666/664	1	NO BID	\$0.00		90%
	QUOTING: MFR: #					
	DELIVERY ARO: /DAYS					
11	BLADE, LDRBKT,L90F,4PC/BLTS,11045948/47	9	NO BID	\$0.00		90%
	QUOTING: MFR: #					
	DELIVERY ARO: /DAYS					
12	BLADE, PLOW, JD 644J LDR, # T171386	2	NO BID	\$0.00		90%
	QUOTING: MFR: #					
	DELIVERY ARO: /DAYS					
13	BLADE, PLOW,JD410G,3/4X8X92-3/8",#T84194	6		\$122.00	\$732.00	90%
	QUOTING: MFR: Valk Manufacturing Company #					
	DELIVERY ARO: 30-60 /DAYS					
14	BLADE, SNOFLOW JOMA ASSY 08', (4', 4')	4	NO BID	\$0.00		90%
	QUOTING: MFR: #					
	DELIVERY ARO: /DAYS					
15	BLADE, SNOFLOW JOMA ASSY 09', (3',3',3')	32	NO BID	\$0.00		90%
	QUOTING: MFR: #					
	DELIVERY ARO: /DAYS					
16	BLADE, SNOFLOW JOMA ASSY 10', (3',3',4')	10	NO BID	\$0.00		90%
	QUOTING: MFR: #					
	DELIVERY ARO: /DAYS					
17	BLADE, SNOFLOW JOMA ASSY 11', (3',4',4')	11	NO BID	\$0.00		90%
	QUOTING: MFR: #					
	DELIVERY ARO: /DAYS					
18	BLADE, SNOFLOW JOMA ASY 14',3',3',4',4'	1	NO BID	\$0.00		90%
	QUOTING: MFR: #					
	DELIVERY ARO: /DAYS					
19	BLADE, SNOFLOW JOMA RPLC 14'-3',3',3',4'	2	NO BID	\$0.00		90%
	QUOTING: MFR: #					
	DELIVERY ARO: /DAYS					
20	BLADE, SNOFLOW JOMA RPLCMT 08'-4',4'	20	NO BID	\$0.00		90%
	QUOTING: MFR: #					
	DELIVERY ARO: /DAYS					
21	BLADE, SNOFLOW JOMA RPLCMT 09'-3',3',3'	77	NO BID	\$0.00		90%
	QUOTING: MFR: #					
	DELIVERY ARO: /DAYS					
22	BLADE, SNOFLOW JOMA RPLCMT 10'-3',3',4'	3	NO BID	\$0.00		90%
	QUOTING: MFR: #					
	DELIVERY ARO: /DAYS					
23	BLADE, SNOFLOW JOMA RPLCMT 11'-3',4',4'	59	NO BID	\$0.00		90%
	QUOTING: MFR: #					
	DELIVERY ARO: /DAYS					
24	BLADE, SNOFLOW JOMA, 36" CARB ADAPT,TXT	113	NO BID	\$0.00		90%
	QUOTING: MFR: #					
	DELIVERY ARO: /DAYS					
25	BLADE, SNOFLOW JOMA, 36" STRAP JM20315s	68	NO BID	\$0.00		90%
	QUOTING: MFR: #					
	DELIVERY ARO: /DAYS					
26	BLADE, SNOFLOW JOMA, 36" X 6", JM20315	251	NO BID	\$0.00		90%
	QUOTING: MFR: #					
	DELIVERY ARO: /DAYS					
27	BLADE, SNOFLOW JOMA, 48" CARB ADAPT,TXT	283	NO BID	\$0.00		90%
	QUOTING: MFR: #					
	DELIVERY ARO: /DAYS					
28	BLADE, SNOFLOW JOMA, 48" STRAP JM20415s	170	NoO BID	\$0.00		90%
	QUOTING: MFR: #					
	DELIVERY ARO: /DAYS					
29	BLADE, SNOWFLOW CARB 3/4"X6"X3'	830		\$148.56	\$123,304.80	90%
	QUOTING: MFR: Valk Manufacturing Company #					
	DELIVERY ARO: 90-150 /DAYS					
30	BLADE, SNOWFLOW CARB 3/4"X6"X4'	2,180		\$198.08	\$431,814.40	90%
	QUOTING: MFR: Valk Manufacturing Company #					
	DELIVERY ARO: 90-150 /DAYS					
31	BLADE, SNOWFLOW CARB 3/4"X6"X5'	250		\$247.60	\$61,900.00	90%
	QUOTING: MFR: Valk Manufacturing Company #					
	DELIVERY ARO: 90-150 /DAYS					
32	BLADE, SNOWFLOW CARB 3/4"X6"X6'	2,024		\$297.12	\$601,370.88	90%
	QUOTING: MFR: Valk Manufacturing Company #					
	DELIVERY ARO: 90-150 /DAYS					
33	BLADE, SNOWFLOW CURB SHOE (L) PC6312EL	1,165	NO BID	\$0.00		90%
	QUOTING: MFR: #					
	DELIVERY ARO: /DAYS					
34	BLADE, SNOWFLOW CURB SHOE (R) PC6312ER	854	NO BID	\$0.00		90%
	QUOTING: MFR: #					
	DELIVERY ARO: /DAYS					
35	BLADE, SNOWFLOW HEAT TREAT 3/4"X6"X4'	60		\$47.70	\$2,862.00	90%
	QUOTING: MFR: Valk Manufacturing Company #					
	DELIVERY ARO: 30-60 /DAYS					
36	BLADE, SNOWFLOW HEAT TREAT 3/4"X6"X5'	10		\$59.65	\$596.50	90%
	QUOTING: MFR: Valk Manufacturing Company #					
	DELIVERY ARO: 30-60 /DAYS					

37	BLADE, SNOWPLOW HEAT TREAT 3/4"x6"x6'	820	\$71.00	\$58,220.00	90%
	QUOTING: MFR: Valk Manufacturing Company	#			
	DELIVERY ARO: 30-60 /DAYS				
38	BLADE, SNOWPLOW HEAT TREAT 3/4"x6"x9'	20	\$108.00	\$2,160.00	90%
	QUOTING: MFR: Valk Manufacturing Company	#			
	DELIVERY ARO: 30-60 /DAYS				
39	BLADE, SNOWPLOW HEAT TREAT 3/4"x8"x6'	30	\$95.40	\$2,862.00	90%
	QUOTING: MFR: Valk Manufacturing Company	#			
	DELIVERY ARO: 30-60 /DAYS				
40	BLADE, SNOWPLOW HEAT TREAT 3/4"x8"x9'	10	\$143.00	\$1,430.00	90%
	QUOTING: MFR: Valk Manufacturing Company	#			
	DELIVERY ARO: 30-60 /DAYS				
41	BLADE, SNOWPLOW JOMA COMPLETE 12'	198	NO BID	\$0.00	
	QUOTING: MFR: #				
	DELIVERY ARO: /DAYS				
42	BLADE, SNOWPLOW JOMA REPLACEMENT 12'	568	NO BID	\$0.00	
	QUOTING: MFR: #				
	DELIVERY ARO: /DAYS				
43	BLADE, SNOWPLOW JOMA, 48" X 6", JM20415	808	NO BID	\$0.00	
	QUOTING: MFR: #				
	DELIVERY ARO: /DAYS				
44	BLADE, V SNOWPLOW, BOSS 10' COMPLETE, TXT	5	\$100.00	\$500.00	90%
	QUOTING: MFR: Valk Manufacturing Company	#			
	DELIVERY ARO: 30-60 /DAYS				
			FOB Destination		
		ESTIMATED	UNIT PRICE	TOTAL	Recycled
STATE IDAHO		QUANTITY			Content
1	Tungsten Carbide Tipped edge - 5" x 3/4" x 4" Long	3110	\$179.12	\$557,063.20	90%
	QUOTING: MFR: Valk Manufacturing Company	#			
	DELIVERY ARO: 60-120 /DAYS				
2	Tungsten Carbide Tipped edge - 5" x 3/4" x 3" Long	580	\$134.34	\$77,917.20	90%
	QUOTING: MFR: Valk Manufacturing Company	#			
	DELIVERY ARO: 60-120 /DAYS				
3	Tungsten Carbide Tipped edge - 6" x 3/4" x 4" Long	3110	\$179.12	\$557,063.20	90%
	QUOTING: MFR: Valk Manufacturing Company	#			
	DELIVERY ARO: 60-120 /DAYS				
4	Tungsten Carbide Tipped edge - 6" x 3/4" x 3" Long	580	\$134.14	\$77,801.20	90%
	QUOTING: MFR: Valk Manufacturing Company	#			
	DELIVERY ARO: 60-120 /DAYS				
STATE NEW YORK		ESTIMATED	FOB Destination	TOTAL	Recycled
		QUANTITY	UNIT PRICE		Content
BLADES					
1	TYPE OF STEEL SAE 1080 (AISI - 1080)	3000	\$78.50	\$235,500.00	90%
	Grader Blade 3/4" x 8" x 72"				
	QUOTING: MFR: Valk Manufacturing Company	#			
	DELIVERY ARO: 30-60 /DAYS				
2	Snow Plow 1/2" x 8" x 132"	350	\$94.12	\$32,942.00	
	QUOTING: MFR: Valk Manufacturing Company	#			
	DELIVERY ARO: 30-60 /DAYS				
3	Snow Plow 1/2" x 8" x 132"	3000	\$94.12	\$282,360.00	90%
	QUOTING: MFR: Valk Manufacturing Company	#			
	DELIVERY ARO: 30-60 /DAYS				
4	Tractor Shovel 7/8" x 10" x 100"	30	\$335.00	\$10,050.00	90%
	QUOTING: MFR: Valk Manufacturing Company	#			
	DELIVERY ARO: 30-60 /DAYS				
5	TYPE OF STEEL SAE 1020 (AISI - 1020)	6000	\$115.56	\$693,360.00	90%
	Snow Plow 3/4" x 6" x 36" with tungsten carbide inserts				
	QUOTING: MFR: Valk Manufacturing Company	#			
	DELIVERY ARO: 60-120 /DAYS				
6	Snow Plow 3/4" x 6" x 48" with tungsten carbide inserts	10500	\$154.08	\$1,617,840.00	90%
	QUOTING: MFR: Valk Manufacturing Company	#			
	DELIVERY ARO: 60-120 /DAYS				
7	Fabricated Plow Shoe	361	\$59.00	\$21,299.00	90%
	QUOTING: MFR: Valk Manufacturing Company	#			
	DELIVERY ARO: 60-120 /DAYS				
8	SECTION CENTER - CARBIDE INSERT BLADE	89	\$91.00	\$8,099.00	90%
	3/4 X 6 X 28 IN.				
	QUOTING: MFR: Valk Manufacturing Company	#			
	DELIVERY ARO: 60-120 /DAYS				
9	SECTION END CARBIDE	3500	\$143.00	\$500,500.00	90%
	INSERT BLADE 3/4 X 6 X 44				
	QUOTING: MFR: Valk Manufacturing Company	#			
	DELIVERY ARO: 60-120 /DAYS				
10	SECTION 5-HOLE CARBIDE INSERT WING	1200	\$136.50	\$163,800.00	90%
	BLADE 3/4 X 6 X 42				
	QUOTING: MFR: Valk Manufacturing Company	#			
	DELIVERY ARO: 60-120 /DAYS				
11	SECTION END 5-HOLE CARBIDE INSERT WING	1100	\$130.00	\$143,000.00	90%
	BLADE 3/4 X 6 X 40 IN				
	QUOTING: MFR: Valk Manufacturing Company	#			
	DELIVERY ARO: 60-120 /DAYS				
12	SECTION 6-HOLE CARBIDE INSERT WING	1100	\$149.50	\$164,450.00	90%
	BLADE 3/4 X 6 X 46 IN				
	QUOTING: MFR: Valk Manufacturing Company	#			
	DELIVERY ARO: 60-120 /DAYS				
13	SECTION CENTER CARB	1200	\$143.00	\$171,600.00	90%
	INSERT BLADE 3/4 X 6 X 44				
	QUOTING: MFR: Valk Manufacturing Company	#			
	DELIVERY ARO: 60-120 /DAYS				

25	8' x 8" x 3/4" - Hole size: 3/4"	20	NO BID	\$0.00	
	QUOTING: MFR: #				
	DELIVERY ARO: /DAYS				
26	8' x 8" x 3/4" - Hole size: 3/4"	300	NO BID	\$0.00	
	QUOTING: MFR: #				
	DELIVERY ARO: /DAYS				
27	9' x 8" x 3/4" - Hole size: 5/8"	23	NO BID	\$0.00	
	QUOTING: MFR: #				
	DELIVERY ARO: /DAYS				
28	10' x 8" x 1" - Hole size: 5/8"	4	NO BID	\$0.00	
	QUOTING: MFR: #				
	DELIVERY ARO: /DAYS				
29	12' x 6" x 3/4" - Hole size: 5/8"	10	NO BID	\$0.00	
	QUOTING: MFR: #				
	DELIVERY ARO: /DAYS				
30	12' x 8" x 3/4" - Hole size: 5/8"	281	NO BID	\$0.00	
	QUOTING: MFR: #				
	DELIVERY ARO: /DAYS				
31	12' x 8" x 1" - Hole size: 5/8"	4	NO BID	\$0.00	
	QUOTING: MFR: #				
	DELIVERY ARO: /DAYS				
32	12' x 8" x 1" - Hole size: 3/4"	10	NO BID	\$0.00	
	QUOTING: MFR: #				
	DELIVERY ARO: /DAYS				
33	14' x 8" x 3/4" - Hole size: 5/8"	60	NO BID	\$0.00	
	QUOTING: MFR: #				
	DELIVERY ARO: /DAYS				
			FOB Destination		Recycled
			ESTIMATE	UNIT PRICE	TOTAL
			QUANTITY		Content
STATE	ALASKA				
	Regular Flat Blades / Heat Treated				
1	3' x 5" x 7/8" - Hole size: 5/8"	80	NO BID	\$0.00	
	QUOTING: MFR: #				
	DELIVERY ARO: /DAYS				
2	3' x 5" x 7/8" - Hole size: 3/4"	2	NO BID	\$0.00	
	QUOTING: MFR: #				
	DELIVERY ARO: /DAYS				
3	3' x 6" x 3/4" - Hole size: 5/8"	137	NO BID	\$0.00	
	QUOTING: MFR: #				
	DELIVERY ARO: /DAYS				
4	3' x 6" x 7/8" - Hole size: 5/8"	46	NO BID	\$0.00	
	QUOTING: MFR: #				
	DELIVERY ARO: /DAYS				
5	3' x 6" x 7/8" - Hole size: 3/4"	64	NO BID	\$0.00	
	QUOTING: MFR: #				
	DELIVERY ARO: /DAYS				
6	3' x 8" x 7/8" - Hole size: 5/8"	68	NO BID	\$0.00	
	QUOTING: MFR: #				
	DELIVERY ARO: /DAYS				
7	3' x 8" x 1" - Hole size: 5/8"	4	NO BID	\$0.00	
	QUOTING: MFR: #				
	DELIVERY ARO: /DAYS				
8	3' x 8" x 1" - Hole size: 3/4"	30	NO BID	\$0.00	
	QUOTING: MFR: #				
	DELIVERY ARO: /DAYS				
9	4' x 5" x 1" - Hole size: 5/8"	4	NO BID	\$0.00	
	QUOTING: MFR: #				
	DELIVERY ARO: /DAYS				
10	4' x 5" x 3/4" - Hole size: 3/4"	6	NO BID	\$0.00	
	QUOTING: MFR: #				
	DELIVERY ARO: /DAYS				
11	4' x 5" x 3/4" - Hole size: 5/8"	6	NO BID	\$0.00	
	QUOTING: MFR: #				
	DELIVERY ARO: /DAYS				
12	4' x 5" x 7/8" - Hole size: 5/8"	135	NO BID	\$0.00	
	QUOTING: MFR: #				
	DELIVERY ARO: /DAYS				
13	4' x 5" x 7/8" - Hole size: 3/4"	16	NO BID	\$0.00	
	QUOTING: MFR: #				
	DELIVERY ARO: /DAYS				
14	4' x 6" x 3/4" - Hole size: 5/8"	162	NO BID	\$0.00	
	QUOTING: MFR: #				
	DELIVERY ARO: /DAYS				
15	4' x 6" x 3/4" - Hole size: 3/4"	15	NO BID	\$0.00	
	QUOTING: MFR: #				
	DELIVERY ARO: /DAYS				
16	4' x 6" x 7/8" - Hole size: 3/4"	477	NO BID	\$0.00	
	QUOTING: MFR: #				
	DELIVERY ARO: /DAYS				
17	4' x 6" x 7/8" - Hole size: 5/8"	316	NO BID	\$0.00	
	QUOTING: MFR: #				
	DELIVERY ARO: /DAYS				
18	4' x 8" x 1" - Hole size: 5/8"	4	NO BID	\$0.00	
	QUOTING: MFR: #				
	DELIVERY ARO: /DAYS				
19	4' x 8" x 1" - Hole size: 5/8"	40	NO BID	\$0.00	
	QUOTING: MFR: #				
	DELIVERY ARO: /DAYS				
20	4' x 8" x 1" - Hole size: 3/4"	50	NO BID	\$0.00	
	QUOTING: MFR: #				
	DELIVERY ARO: /DAYS				
21	4' x 8" x 1" - Hole size: 3/4"	330	NO BID	\$0.00	
	QUOTING: MFR: #				
	DELIVERY ARO: /DAYS				

22	4' x 8" x 3/4" - Hole size: 3/4"	15	NO BID	\$0.00		
	QUOTING: MFR: #					
	DELIVERY ARO: /DAYS					
23	4' x 8" x 3/4" - Hole size: 5/8"	388	NO BID	\$0.00		
	QUOTING: MFR: #					
	DELIVERY ARO: /DAYS					
24	4' x 8" x 7/8" - Hole size: 5/8"	213	NO BID	\$0.00		
	QUOTING: MFR: #					
	DELIVERY ARO: /DAYS					
25	4' x 10" x 1" - Hole size: 3/4"	90	NO BID	\$0.00		
	QUOTING: MFR: #					
	DELIVERY ARO: /DAYS					
26	5' x 6" x 3/4" - Hole size: 5/8"	2	NO BID	\$0.00		
	QUOTING: MFR: #					
	DELIVERY ARO: /DAYS					
27	5' x 6" x 7/8" - Hole size: 3/4"	2	NO BID	\$0.00		
	QUOTING: MFR: #					
	DELIVERY ARO: /DAYS					
28	5' x 6" x 7/8" - Hole size: 5/8"	8	NO BID	\$0.00		
	QUOTING: MFR: #					
	DELIVERY ARO: /DAYS					
29	6' x 6" x 1" - Hole size: 5/8"	54	NO BID	\$0.00		
	QUOTING: MFR: #					
	DELIVERY ARO: /DAYS					
30	6' x 8" x 3/4" - Hole size: 5/8"	1,818	NO BID	\$0.00		
	QUOTING: MFR: #					
	DELIVERY ARO: /DAYS					
31	6' x 8" x 3/4" - Hole size: 5/8"	398	NO BID	\$0.00		
	QUOTING: MFR: #					
	DELIVERY ARO: /DAYS					
32	6' x 8" x 3/4" - Hole size: 3/4"	100	NO BID	\$0.00		
	QUOTING: MFR: #					
	DELIVERY ARO: /DAYS					
33	6' x 8" x 3/4" - Hole size: 5/8"	100	NO BID	\$0.00		
	QUOTING: MFR: #					
	DELIVERY ARO: /DAYS					
34	6' x 8" x 3/4" - Hole size: 3/4"	50	NO BID	\$0.00		
	QUOTING: MFR: #					
	DELIVERY ARO: /DAYS					
35	7' x 8" x 1" - Hole size: 3/4"	20	NO BID	\$0.00		
	QUOTING: MFR: #					
	DELIVERY ARO: /DAYS					
36	7' x 8" x 1" - Hole size: 3/4"	30	NO BID	\$0.00		
	QUOTING: MFR: #					
	DELIVERY ARO: /DAYS					
37	7' x 8" x 1" - Hole size: 5/8"	250	NO BID	\$0.00		
	QUOTING: MFR: #					
	DELIVERY ARO: /DAYS					
38	7' x 8" 3/4" - Hole size: 3/4"	584	NO BID	\$0.00		
	QUOTING: MFR: #					
	DELIVERY ARO: /DAYS					
39	7' x 8" x 3/4" - Hole size: 5/8"	604	NO BID	\$0.00		
	QUOTING: MFR: #					
	DELIVERY ARO: /DAYS					
40	7' x 8" x 3/4" - Hole size: 5/8"	120	NO BID	\$0.00		
	QUOTING: MFR: #					
	DELIVERY ARO: /DAYS					
41	7' x 8" x 3/4" - Hole size: 3/4"	956	NO BID	\$0.00		
	QUOTING: MFR: #					
	DELIVERY ARO: /DAYS					
42	7' x 8" x 3/4" - Hole size: 5/8"	448	NO BID	\$0.00		
	QUOTING: MFR: #					
	DELIVERY ARO: /DAYS					
43	7' x 8" x 5/8" - Hole size: 3/4"	48	NO BID	\$0.00		
	QUOTING: MFR: #					
	DELIVERY ARO: /DAYS					
44	7' x 8" x 5/8" - Hole size: 5/8"	36	NO BID	\$0.00		
	QUOTING: MFR: #					
	DELIVERY ARO: /DAYS					
45	8' x 8" x 1" - Hole size: 3/4"	80	NO BID	\$0.00		
	QUOTING: MFR: #					
	DELIVERY ARO: /DAYS					
46	8' x 8" x 1" - Hole size: 3/4"	50	NO BID	\$0.00		
	QUOTING: MFR: #					
	DELIVERY ARO: /DAYS					
47	8' x 8" x 3/4" - Hole size: 3/4"	40	NO BID	\$0.00		
	QUOTING: MFR: #					
	DELIVERY ARO: /DAYS					
48	8' x 8" x 3/4" - Hole size: 3/4" -	20	NO BID	\$0.00		
	QUOTING: MFR: #					
	DELIVERY ARO: /DAYS					
49	8' x 8" x 3/4" - Hole size: 3/4"	300	NO BID	\$0.00		
	QUOTING: MFR: #					
	DELIVERY ARO: /DAYS					
50	9' x 8" x 3/4" - Hole size: 5/8"	23	NO BID	\$0.00		
	QUOTING: MFR: #					
	DELIVERY ARO: /DAYS					
51	9' x 8" x 5/8" - Hole size: 5/8"	1	NO BID	\$0.00		
	QUOTING: MFR: #					
	DELIVERY ARO: /DAYS					
52	10' x 8" x 1" - Hole size: 5/8"	4	NO BID	\$0.00		
	QUOTING: MFR: #					

	DELIVERY ARO: _____/DAYS					
53	12' x 6" x 3/4" - Hole size: 5/8"	10	NO BID	\$0.00		
	QUOTING: MFR: #					
	DELIVERY ARO: _____/DAYS					
54	12' x 8" x 3/4" - Hole size: 5/8"	281	NO BID	\$0.00		
	QUOTING: MFR: #					
	DELIVERY ARO: _____/DAYS					
55	12' x 8" x 1" - Hole size: 5/8"	4	NO BID	\$0.00		
	QUOTING: MFR: #					
	DELIVERY ARO: _____/DAYS					
56	12' x 8" x 1" - Hole size: 3/4"	10	NO BID	\$0.00		
	QUOTING: MFR: #					
	DELIVERY ARO: _____/DAYS					
57	14' x 8" x 3/4" - Hole size: 5/8"	60	NO BID	\$0.00		
	QUOTING: MFR: #					
	DELIVERY ARO: _____/DAYS					
			NO BID	\$0.00	Recycled	
					Content	
STATE	ALASKA					
	Regular Flat Blades / High Carbon					
		ESTIMATED		TOTAL		
		QUANTITY				
1	3' x 5" x 7/8" - Hole size: 5/8"	80	NO BID	\$0.00		
	QUOTING: MFR: #					
	DELIVERY ARO: _____/DAYS					
2	3' x 5" x 7/8" - Hole size 3/4"	2	NO BID	\$0.00		
	QUOTING: MFR: #					
	DELIVERY ARO: _____/DAYS					
3	3' x 6" x 3/4" - Hole size: 5/8"	137	NO BID	\$0.00		
	QUOTING: MFR: #					
	DELIVERY ARO: _____/DAYS					
4	3' x 6" x 7/8" - Hole size: 5/8"	46	NO BID	\$0.00		
	QUOTING: MFR: #					
	DELIVERY ARO: _____/DAYS					
5	3' x 6" x 7/8" - Hole size: 3/4"	64	NO BID	\$0.00		
	QUOTING: MFR: #					
	DELIVERY ARO: _____/DAYS					
6	3' x 8" x 7/8" - Hole size: 5/8"	68	NO BID	\$0.00		
	QUOTING: MFR: #					
	DELIVERY ARO: _____/DAYS					
7	3' x 8" x 1" - Hole size: 5/8"	4	NO BID	\$0.00		
	QUOTING: MFR: #					
	DELIVERY ARO: _____/DAYS					
8	3' x 8" x 1" - Hole size: 3/4"	30	NO BID	\$0.00		
	QUOTING: MFR: #					
	DELIVERY ARO: _____/DAYS					
9	4' x 5" x 1" - Hole size: 5/8"	4	NO BID	\$0.00		
	QUOTING: MFR: #					
	DELIVERY ARO: _____/DAYS					
10	4' x 5" x 3/4" - Hole size: 3/4"	6	NO BID	\$0.00		
	QUOTING: MFR: #					
	DELIVERY ARO: _____/DAYS					
11	4' x 5" x 3/4" - Hole size: 5/8"	6	NO BID	\$0.00		
	QUOTING: MFR: #					
	DELIVERY ARO: _____/DAYS					
12	4' x 5" x 7/8" - Hole size: 5/8"	135	NO BID	\$0.00		
	QUOTING: MFR: #					
	DELIVERY ARO: _____/DAYS					
13	4' x 5" x 7/8" - Hole size: 3/4"	16	NO BID	\$0.00		
	QUOTING: MFR: #					
	DELIVERY ARO: _____/DAYS					
14	4' x 6" x 3/4" - Hole size: 5/8"	162	NO BID	\$0.00		
	QUOTING: MFR: #					
	DELIVERY ARO: _____/DAYS					
15	4' x 6" x 3/4" - Hole size: 3/4"	15	NO BID	\$0.00		
	QUOTING: MFR: #					
	DELIVERY ARO: _____/DAYS					
16	4' x 6" x 7/8" - Hole size: 3/4"	477	NO BID	\$0.00		
	QUOTING: MFR: #					
	DELIVERY ARO: _____/DAYS					
17	4' x 6" x 7/8" - Hole size: 5/8"	316	NO BID	\$0.00		
	QUOTING: MFR: #					
	DELIVERY ARO: _____/DAYS					
18	4' x 8" x 1" - Hole size: 5/8"	4	NO BID	\$0.00		
	QUOTING: MFR: #					
	DELIVERY ARO: _____/DAYS					
19	4' x 8" x 1" - Hole size: 5/8"	40	NO BID	\$0.00		
	QUOTING: MFR: #					
	DELIVERY ARO: _____/DAYS					
20	4' x 8" x 1" - Hole size: 3/4"	50	NO BID	\$0.00		
	QUOTING: MFR: #					
	DELIVERY ARO: _____/DAYS					
21	4' x 8" x 1" - Hole size: 3/4"	330	NO BID	\$0.00		
	QUOTING: MFR: #					
	DELIVERY ARO: _____/DAYS					
22	4' x 8" x 3/4" - Hole size: 3/4"	15	NO BID	\$0.00		
	QUOTING: MFR: #					
	DELIVERY ARO: _____/DAYS					
23	4' x 8" x 3/4" - Hole size: 5/8"	388	NO BID	\$0.00		
	QUOTING: MFR: #					
	DELIVERY ARO: _____/DAYS					
24	4' x 8" x 7/8" - Hole size: 5/8"	213	NO BID	\$0.00		
	QUOTING: MFR: #					
	DELIVERY ARO: _____/DAYS					
25	4' x 10" x 1" - Hole size: 3/4"	90	NO BID	\$0.00		

	QUOTING: MFR:	#				
	DELIVERY ARO: /DAYS					
26	5' x 6" x 3/4" - Hole size: 5/8"		2	NO BID	\$0.00	
	QUOTING: MFR:	#				
	DELIVERY ARO: /DAYS					
27	5' x 6" x 7/8" - Hole size: 3/4"		2	NO BID	\$0.00	
	QUOTING: MFR:	#				
	DELIVERY ARO: /DAYS					
28	5' x 6" x 7/8" - Hole size: 5/8"		8	NO BID	\$0.00	
	QUOTING: MFR:	#				
	DELIVERY ARO: /DAYS					
29	6' x 6" x 1" - Hole size: 5/8"		54	NO BID	\$0.00	
	QUOTING: MFR:	#				
	DELIVERY ARO: /DAYS					
30	6' x 8" x 3/4" - Hole size: 5/8"		1,818	NO BID	\$0.00	
	QUOTING: MFR:	#				
	DELIVERY ARO: /DAYS					
31	6' x 8" x 3/4" - Hole size: 5/8"		398	NO BID	\$0.00	
	QUOTING: MFR:	#				
	DELIVERY ARO: /DAYS					
32	6' x 8" x 3/4" - Hole size: 3/4"		100	NO BID	\$0.00	
	QUOTING: MFR:	#				
	DELIVERY ARO: /DAYS					
33	6' x 8" x 3/4" - Hole size: 5/8"		100	NO BID	\$0.00	
	QUOTING: MFR:	#				
	DELIVERY ARO: /DAYS					
34	6' x 8" x 3/4" - Hole size: 3/4"		50	NO BID	\$0.00	
	QUOTING: MFR:	#				
	DELIVERY ARO: /DAYS					
35	7' x 8" x 1" - Hole size: 3/4"		20	NO BID	\$0.00	
	QUOTING: MFR:	#				
	DELIVERY ARO: /DAYS					
36	7' x 8" x 1" - Hole size: 3/4"		30	NO BID	\$0.00	
	QUOTING: MFR:	#				
	DELIVERY ARO: /DAYS					
37	7' x 8" x 1" - Hole size: 5/8"		250	NO BID	\$0.00	
	QUOTING: MFR:	#				
	DELIVERY ARO: /DAYS					
38	7' x 8" 3/4" - Hole size: 3/4"		584	NO BID	\$0.00	
	QUOTING: MFR:	#				
	DELIVERY ARO: /DAYS					
39	7' x 8" x 3/4" - Hole size: 5/8"		604	NO BID	\$0.00	
	QUOTING: MFR:	#				
	DELIVERY ARO: /DAYS					
40	7' x 8" x 3/4" - Hole size: 5/8"		120	NO BID	\$0.00	
	QUOTING: MFR:	#				
	DELIVERY ARO: /DAYS					
41	7' x 8" x 3/4" - Hole size: 3/4"		956	NO BID	\$0.00	
	QUOTING: MFR:	#				
	DELIVERY ARO: /DAYS					
42	7' x 8" x 3/4" - Hole size: 5/8"		448	NO BID	\$0.00	
	QUOTING: MFR:	#				
	DELIVERY ARO: /DAYS					
43	7' x 8" x 5/8" - Hole size: 3/4"		48	NO BID	\$0.00	
	QUOTING: MFR:	#				
	DELIVERY ARO: /DAYS					
44	7' x 8" x 5/8" - Hole size: 5/8"		36	NO BID	\$0.00	
	QUOTING: MFR:	#				
	DELIVERY ARO: /DAYS					
45	8' x 8" x 1" - Hole size: 3/4"		80	NO BID	\$0.00	
	QUOTING: MFR:	#				
	DELIVERY ARO: /DAYS					
46	8' x 8" x 1" - Hole size: 3/4"		50	NO BID	\$0.00	
	QUOTING: MFR:	#				
	DELIVERY ARO: /DAYS					
47	8' x 8" x 3/4" - Hole size: 3/4"		40	NO BID	\$0.00	
	QUOTING: MFR:	#				
	DELIVERY ARO: /DAYS					
48	8' x 8" x 3/4" - Hole size: 3/4"		20	NO BID	\$0.00	
	QUOTING: MFR:	#				
	DELIVERY ARO: /DAYS					
49	8' x 8" x 3/4" - Hole size: 3/4"		300	NO BID	\$0.00	
	QUOTING: MFR:	#				
	DELIVERY ARO: /DAYS					
50	9' x 8" x 3/4" - Hole size: 5/8"		23	NO BID	\$0.00	
	QUOTING: MFR:	#				
	DELIVERY ARO: /DAYS					
51	9' x 8" x 5/8" - Hole size: 5/8"		1	NO BID	\$0.00	
	QUOTING: MFR:	#				
	DELIVERY ARO: /DAYS					
52	10' x 8" x 1" - Hole size: 5/8"		4	NO BID	\$0.00	
	QUOTING: MFR:	#				
	DELIVERY ARO: /DAYS					
53	12' x 6" x 3/4" - Hole size: 5/8"		10	NO BID	\$0.00	
	QUOTING: MFR:	#				
	DELIVERY ARO: /DAYS					
54	12' x 8" x 3/4" - Hole size: 5/8"		281	NO BID	\$0.00	
	QUOTING: MFR:	#				
	DELIVERY ARO: /DAYS					
55	12' x 8" x 1" - Hole size: 5/8"		4	NO BID	\$0.00	
	QUOTING: MFR:	#				
	DELIVERY ARO: /DAYS					

56	12' x 8" x 1" - Hole size: 3/4"		10	NO BID	\$0.00		
	QUOTING: MFR: #						
	DELIVERY ARO: /DAYS						
57	14' x 8" x 3/4" - Hole size: 5/8"		60	NO BID	\$0.00		
	QUOTING: MFR: #						
	DELIVERY ARO: /DAYS						
					\$0.00	Recycled	
						Content	
STATE	ALASKA						
	ESTIMATED				TOTAL		
	QUANTITY						
	Scarifier Blades / 1.4" Tooth Width						
1	3' x 8" x 1" - Hole size: 5/8" - Tooth length: 4.25"		4	NO BID	\$0.00		
	QUOTING: MFR: #						
	DELIVERY ARO: /DAYS						
2	3' x 8" x 1" - Hole size: 3/4" - Tooth length: 4.25"		20	NO BID	\$0.00		
	QUOTING: MFR: #						
	DELIVERY ARO: /DAYS						
3	4' x 8" x 1" - Hole size: 5/8" - Tooth length: 4.25"		4	NO BID	\$0.00		
	QUOTING: MFR: #						
	DELIVERY ARO: /DAYS						
4	4' x 8" x 1" - Hole size: 5/8" - Tooth length: 4.25"		40	NO BID	\$0.00		
	QUOTING: MFR: #						
	DELIVERY ARO: /DAYS						
5	4' x 8" x 1" - Hole size: 3/4" - Tooth length: 4.25"		50	NO BID	\$0.00		
	QUOTING: MFR: #						
	DELIVERY ARO: /DAYS						
6	4' x 8" x 1" - Hole size: 3/4" - Tooth length: 4.25"		50	NO BID	\$0.00		
	QUOTING: MFR: #						
	DELIVERY ARO: /DAYS						
7	4' x 8" x 3/4" - Hole size: 3/4" - Tooth length: 4.25"		15	NO BID	\$0.00		
	QUOTING: MFR: #						
	DELIVERY ARO: /DAYS						
8	4' x 8" x 3/4" - Hole size: 5/8" - Tooth length: 4.25"		10	NO BID	\$0.00		
	QUOTING: MFR: #						
	DELIVERY ARO: /DAYS						
9	6' x 8" x 3/4" - Hole size: 5/8" - Tooth length: 4.25"		50	NO BID	\$0.00		
	QUOTING: MFR: #						
	DELIVERY ARO: /DAYS						
10	6' x 8" x 3/4" - Hole size: 5/8" - Tooth length: 4.25"		40	NO BID	\$0.00		
	QUOTING: MFR: #						
	DELIVERY ARO: /DAYS						
11	6' x 8" x 3/4" - Hole size: 3/4" - Tooth length: 4.25"		50	NO BID	\$0.00		
	QUOTING: MFR: #						
	DELIVERY ARO: /DAYS						
12	6' x 8" x 3/4" - Hole size: 5/8" - Tooth length: 2.5"		50	NO BID	\$0.00		
	QUOTING: MFR: #						
	DELIVERY ARO: /DAYS						
13	6' x 8" x 3/4" - Hole size: 3/4" - Tooth length: 4.25"		50	NO BID	\$0.00		
	QUOTING: MFR: #						
	DELIVERY ARO: /DAYS						
14	7' x 8" x 1" - Hole size: 3/4" - Tooth length: 4.25"		20	NO BID	\$0.00		
	QUOTING: MFR: #						
	DELIVERY ARO: /DAYS						
15	7' x 8" x 1" - Hole size: 3/4" - Tooth length: 4.25"		30	NO BID	\$0.00		
	QUOTING: MFR: #						
	DELIVERY ARO: /DAYS						
16	7' x 8" x 1" - Hole size: 5/8" - Tooth length: 4.25"		100	NO BID	\$0.00		
	QUOTING: MFR: #						
	DELIVERY ARO: /DAYS						
17	7' x 8" 3/4" - Hole size: 3/4" - Tooth length: 4.25"		100	NO BID	\$0.00		
	QUOTING: MFR: #						
	DELIVERY ARO: /DAYS						
18	7' x 8" x 3/4" - Hole size: 5/8" - Tooth length: 4.25"		100	NO BID	\$0.00		
	QUOTING: MFR: #						
	DELIVERY ARO: /DAYS						
19	7' x 8" x 3/4" - Hole size: 5/8" - Tooth length: 2.5"		50	NO BID	\$0.00		
	QUOTING: MFR: #						
	DELIVERY ARO: /DAYS						
20	7' x 8" x 3/4" - Hole size: 3/4" - Tooth length: 4.25"		50	NO BID	\$0.00		
	QUOTING: MFR: #						
	DELIVERY ARO: /DAYS						
21	7' x 8" x 3/4" - Hole size: 5/8" - Tooth length: 4.25"		200	NO BID	\$0.00		
	QUOTING: MFR: #						
	DELIVERY ARO: /DAYS						
22	8' x 8" x 1" - Hole size: 3/4" - Tooth length: 4.25"		80	NO BID	\$0.00		
	QUOTING: MFR: #						
	DELIVERY ARO: /DAYS						
23	8' x 8" x 1" - Hole size: 3/4" - Tooth length: 4.25"		50	NO BID	\$0.00		
	QUOTING: MFR: #						
	DELIVERY ARO: /DAYS						
24	8' x 8" x 3/4" - Hole size: 3/4" - Tooth length: 4.25"		40	NO BID	\$0.00		
	QUOTING: MFR: #						
	DELIVERY ARO: /DAYS						
25	8' x 8" x 3/4" - Hole size: 3/4" - Tooth length: 2.5"		20	NO BID	\$0.00		
	QUOTING: MFR: #						
	DELIVERY ARO: /DAYS						
26	8' x 8" x 3/4" - Hole size: 3/4" - Tooth length: 4.25"		20	NO BID	\$0.00		
	QUOTING: MFR: #						
	DELIVERY ARO: /DAYS						
27	9' x 8" x 3/4" - Hole size: 5/8" - Tooth length: 4.25"		20	NO BID	\$0.00		
	QUOTING: MFR: #						
	DELIVERY ARO: /DAYS						
28	10' x 8" x 1" - Hole size: 5/8" - Tooth length: 4.25"		4	NO BID	\$0.00		

QUOTING: MFR:		#					
DELIVERY ARO: /DAYS							
29	12' x 8" x 3/4" - Hole size: 5/8" - Tooth length: 4.25"	100	NO BID	\$0.00			
QUOTING: MFR:		#					
DELIVERY ARO: /DAYS							
30	12' x 8" x 1" - Hole size: 5/8" - Tooth length: 4.25"	4	NO BID	\$0.00			
QUOTING: MFR:		#					
DELIVERY ARO: /DAYS							
31	12' x 8" x 1" - Hole size: 3/4" - Tooth length: 4.25"	10	NO BID	\$0.00			
QUOTING: MFR:		#					
DELIVERY ARO: /DAYS							
32	14' x 8" x 3/4" - Hole size: 5/8" - Tooth length: 4.25"	20	NO BID	\$0.00			
QUOTING: MFR:		#					
DELIVERY ARO: /DAYS							
			FOB Destination				
			ESTIMATED QUANTITY	UNIT PRICE	TOTAL	Recycled Content	
STATE	ALASKA						
	Scarifier Blades / 2.5" Tooth Width						
1	3' x 8" x 1" - Hole size: 5/8" - Tooth length: 4.25"	4	NO BID	\$0.00			
QUOTING: MFR:		#					
DELIVERY ARO: /DAYS							
2	3' x 8" x 1" - Hole size: 3/4" - Tooth length: 4.25"	30	NO BID	\$0.00			
QUOTING: MFR:		#					
DELIVERY ARO: /DAYS							
3	4' x 8" x 1" - Hole size: 5/8" - Tooth length: 4.25"	4	NO BID	\$0.00			
QUOTING: MFR:		#					
DELIVERY ARO: /DAYS							
4	4' x 8" x 1" - Hole size: 5/8" - Tooth length: 4.25"	40	NO BID	\$0.00			
QUOTING: MFR:		#					
DELIVERY ARO: /DAYS							
5	4' x 8" x 1" - Hole size: 3/4" - Tooth length: 4.25"	50	NO BID	\$0.00			
QUOTING: MFR:		#					
DELIVERY ARO: /DAYS							
6	4' x 8" x 1" - Hole size: 3/4" - Tooth length: 4.25"	330	NO BID	\$0.00			
QUOTING: MFR:		#					
DELIVERY ARO: /DAYS							
7	4' x 8" x 3/4" - Hole size: 3/4" - Tooth length: 4.25"	15	NO BID	\$0.00			
QUOTING: MFR:		#					
DELIVERY ARO: /DAYS							
8	4' x 8" x 3/4" - Hole size: 5/8" - Tooth length: 4.25"	388	NO BID	\$0.00			
QUOTING: MFR:		#					
DELIVERY ARO: /DAYS							
9	6' x 8" x 3/4" - Hole size: 5/8" - Tooth length: 4.25"	1,818	NO BID	\$0.00			
QUOTING: MFR:		#					
DELIVERY ARO: /DAYS							
10	6' x 8" x 3/4" - Hole size: 5/8" - Tooth length: 4.25"	398	NO BID	\$0.00			
QUOTING: MFR:		#					
DELIVERY ARO: /DAYS							
11	6' x 8" x 3/4" - Hole size: 3/4" - Tooth length: 4.25"	100	NO BID	\$0.00			
QUOTING: MFR:		#					
DELIVERY ARO: /DAYS							
12	6' x 8" x 3/4" - Hole size: 5/8" - Tooth length: 2.5"	100	NO BID	\$0.00			
QUOTING: MFR:		#					
DELIVERY ARO: /DAYS							
13	6' x 8" x 3/4" - Hole size: 3/4" - Tooth length: 4.25"	50	NO BID	\$0.00			
QUOTING: MFR:		#					
DELIVERY ARO: /DAYS							
14	7' x 8" x 1" - Hole size: 3/4" - Tooth length: 4.25"	20	NO BID	\$0.00			
QUOTING: MFR:		#					
DELIVERY ARO: /DAYS							
15	7' x 8" x 1" - Hole size: 3/4" - Tooth length: 4.25"	30	NO BID	\$0.00			
QUOTING: MFR:		#					
DELIVERY ARO: /DAYS							
17	7' x 8" x 1" - Hole size: 5/8" - Tooth length: 4.25"	250	NO BID	\$0.00			
QUOTING: MFR:		#					
DELIVERY ARO: /DAYS							
17	7' x 8" x 3/4" - Hole size: 3/4" - Tooth length: 4.25"	584	NO BID	\$0.00			
QUOTING: MFR:		#					
DELIVERY ARO: /DAYS							
18	7' x 8" x 3/4" - Hole size: 5/8" - Tooth length: 4.25"	604	NO BID	\$0.00			
QUOTING: MFR:		#					
DELIVERY ARO: /DAYS							
19	7' x 8" x 3/4" - Hole size: 5/8" - Tooth length: 2.5"	120	NO BID	\$0.00			
QUOTING: MFR:		#					
DELIVERY ARO: /DAYS							
20	7' x 8" x 3/4" - Hole size: 3/4" - Tooth length: 4.25"	956	NO BID	\$0.00			
QUOTING: MFR:		#					
DELIVERY ARO: /DAYS							
21	7' x 8" x 3/4" - Hole size: 5/8" - Tooth length: 4.25"	448	NO BID	\$0.00			
QUOTING: MFR:		#					
DELIVERY ARO: /DAYS							
22	7' x 8" x 5/8" - Hole size: 3/4" - Tooth length: 4.25"	48	NO BID	\$0.00			
QUOTING: MFR:		#					
DELIVERY ARO: /DAYS							
23	7' x 8" x 5/8" - Hole size: 5/8" - Tooth length: 4.25"	36	NO BID	\$0.00			
QUOTING: MFR:		#					
DELIVERY ARO: /DAYS							
24	8' x 8" x 1" - Hole size: 3/4" - Tooth length: 4.25"	80	NO BID	\$0.00			
QUOTING: MFR:		#					
DELIVERY ARO: /DAYS							
25	8' x 8" x 1" - Hole size: 3/4" - Tooth length: 4.25"	50	NO BID	\$0.00			
QUOTING: MFR:		#					

	DELIVERY ARO: _____/DAYS						
26	8' x 8" x 3/4" - Hole size: 3/4" - Tooth length: 4.25"	40	NO BID	\$0.00			
	QUOTING: MFR: # _____						
	DELIVERY ARO: _____/DAYS						
27	8' x 8" x 3/4" - Hole size: 3/4" - Tooth length: 2.5"	20	NO BID	\$0.00			
	QUOTING: MFR: # _____						
	DELIVERY ARO: _____/DAYS						
28	8' x 8" x 3/4" - Hole size: 3/4" - Tooth length: 4.25"	300	NO BID	\$0.00			
	QUOTING: MFR: # _____						
	DELIVERY ARO: _____/DAYS						
29	9' x 8" x 3/4" - Hole size: 5/8" - Tooth length: 4.25"	23	NO BID	\$0.00			
	QUOTING: MFR: # _____						
	DELIVERY ARO: _____/DAYS						
30	9' x 8" x 5/8" - Hole size: 5/8" - Tooth length: 4.25"	1	NO BID	\$0.00			
	QUOTING: MFR: # _____						
	DELIVERY ARO: _____/DAYS						
31	10' x 8" x 1" - Hole size: 5/8" - Tooth length: 4.25"	4	NO BID	\$0.00			
	QUOTING: MFR: # _____						
	DELIVERY ARO: _____/DAYS						
32	12' x 6" x 3/4" - Hole size: 5/8" - Tooth length: 4.25"	10	NO BID	\$0.00			
	QUOTING: MFR: # _____						
	DELIVERY ARO: _____/DAYS						
33	12' x 8" x 3/4" - Hole size: 5/8" - Tooth length: 4.25"	281	NO BID	\$0.00			
	QUOTING: MFR: # _____						
	DELIVERY ARO: _____/DAYS						
34	12' x 8" x 1" - Hole size: 5/8" - Tooth length: 4.25"	4	NO BID	\$0.00			
	QUOTING: MFR: # _____						
	DELIVERY ARO: _____/DAYS						
35	12' x 8" x 1" - Hole size: 3/4" - Tooth length: 4.25"	10	NO BID	\$0.00			
	QUOTING: MFR: # _____						
	DELIVERY ARO: _____/DAYS						
36	14' x 8" x 3/4" - Hole size: 5/8" - Tooth length: 4.25"	60	NO BID	\$0.00			
	QUOTING: MFR: # _____						
	DELIVERY ARO: _____/DAYS						
			FOB Destination				
			ESTIMATED				
			QUANTITY	UNIT PRICE	TOTAL		Recycled
							Content
	ALASKA						
	<i>Single Carbide Insert Blades</i>						
1	3' x 5" x 7/8" - Hole size: 5/8"	80	NO BID	\$0.00			
	QUOTING: MFR: # _____						
	DELIVERY ARO: _____/DAYS						
2	3' x 5" x 7/8" - Hole size 3/4"	2	NO BID	\$0.00			
	QUOTING: MFR: # _____						
	DELIVERY ARO: _____/DAYS						
3	3' x 6" x 3/4" - Hole size: 5/8"	137	NO BID	\$0.00			
	QUOTING: MFR: # _____						
	DELIVERY ARO: _____/DAYS						
4	3' x 6" x 7/8" - Hole size: 5/8"	46	NO BID	\$0.00			
	QUOTING: MFR: # _____						
	DELIVERY ARO: _____/DAYS						
5	3' x 6" x 7/8" - Hole size: 3/4"	64	NO BID	\$0.00			
	QUOTING: MFR: # _____						
	DELIVERY ARO: _____/DAYS						
6	3' x 8" x 7/8" - Hole size: 5/8"	68	NO BID	\$0.00			
	QUOTING: MFR: # _____						
	DELIVERY ARO: _____/DAYS						
7	3' x 8" x 1" - Hole size: 5/8"	4	NO BID	\$0.00			
	QUOTING: MFR: # _____						
	DELIVERY ARO: _____/DAYS						
8	3' x 8" x 1" - Hole size: 3/4"	30	NO BID	\$0.00			
	QUOTING: MFR: # _____						
	DELIVERY ARO: _____/DAYS						
9	4' x 5" x 1" - Hole size: 5/8"	4	NO BID	\$0.00			
	QUOTING: MFR: # _____						
	DELIVERY ARO: _____/DAYS						
10	4' x 5" x 3/4" - Hole size: 3/4"	6	NO BID	\$0.00			
	QUOTING: MFR: # _____						
	DELIVERY ARO: _____/DAYS						
11	4' x 5" x 3/4" - Hole size: 5/8"	6	NO BID	\$0.00			
	QUOTING: MFR: # _____						
	DELIVERY ARO: _____/DAYS						
12	4' x 5" x 7/8" - Hole size: 5/8"	135	NO BID	\$0.00			
	QUOTING: MFR: # _____						
	DELIVERY ARO: _____/DAYS						
13	4' x 5" x 7/8" - Hole size: 3/4"	16	NO BID	\$0.00			
	QUOTING: MFR: # _____						
	DELIVERY ARO: _____/DAYS						
14	4' x 6" x 3/4" - Hole size: 5/8"	162	NO BID	\$0.00			
	QUOTING: MFR: # _____						
	DELIVERY ARO: _____/DAYS						
15	4' x 6" x 3/4" - Hole size: 3/4"	15	NO BID	\$0.00			
	QUOTING: MFR: # _____						
	DELIVERY ARO: _____/DAYS						
16	4' x 6" x 7/8" - Hole size: 3/4"	477	NO BID	\$0.00			
	QUOTING: MFR: # _____						
	DELIVERY ARO: _____/DAYS						
17	4' x 6" x 7/8" - Hole size: 5/8"	316	NO BID	\$0.00			
	QUOTING: MFR: # _____						
	DELIVERY ARO: _____/DAYS						
18	4' x 8" x 1" - Hole size: 5/8"	4	NO BID	\$0.00			
	QUOTING: MFR: # _____						
	DELIVERY ARO: _____/DAYS						
19	4' x 8" x 1" - Hole size: 5/8"	40	NO BID	\$0.00			

	QUOTING: MFR: #				
	DELIVERY ARO: /DAYS				
20	4' x 8" x 1" - Hole size: 3/4"	50	NO BID	\$0.00	
	QUOTING: MFR: #				
	DELIVERY ARO: /DAYS				
21	4' x 8" x 1" - Hole size: 3/4"	330	NO BID	\$0.00	
	QUOTING: MFR: #				
	DELIVERY ARO: /DAYS				
22	4' x 8" x 3/4" - Hole size: 3/4"	15	NO BID	\$0.00	
	QUOTING: MFR: #				
	DELIVERY ARO: /DAYS				
23	4' x 8" x 3/4" - Hole size: 5/8"	388	NO BID	\$0.00	
	QUOTING: MFR: #				
	DELIVERY ARO: /DAYS				
24	4' x 8" x 7/8" - Hole size: 5/8"	213	NO BID	\$0.00	
	QUOTING: MFR: #				
	DELIVERY ARO: /DAYS				
25	4' x 10" x 1" - Hole size: 3/4"	90	NO BID	\$0.00	
	QUOTING: MFR: #				
	DELIVERY ARO: /DAYS				
26	5' x 6" x 3/4" - Hole size: 5/8"	2	NO BID	\$0.00	
	QUOTING: MFR: #				
	DELIVERY ARO: /DAYS				
27	5' x 6" x 7/8" - Hole size: 3/4"	2	NO BID	\$0.00	
	QUOTING: MFR: #				
	DELIVERY ARO: /DAYS				
28	5' x 6" x 7/8" - Hole size: 5/8"	8	NO BID	\$0.00	
	QUOTING: MFR: #				
	DELIVERY ARO: /DAYS				
29	6' x 6" x 1" - Hole size: 5/8"	54	NO BID	\$0.00	
	QUOTING: MFR: #				
	DELIVERY ARO: /DAYS				
30	6' x 8" x 3/4" - Hole size: 5/8"	1,818	NO BID	\$0.00	
	QUOTING: MFR: #				
	DELIVERY ARO: /DAYS				
31	6' x 8" x 3/4" - Hole size: 5/8"	398	NO BID	\$0.00	
	QUOTING: MFR: #				
	DELIVERY ARO: /DAYS				
32	6' x 8" x 3/4" - Hole size: 3/4"	100	NO BID	\$0.00	
	QUOTING: MFR: #				
	DELIVERY ARO: /DAYS				
33	6' x 8" x 3/4" - Hole size: 5/8"	100	NO BID	\$0.00	
	QUOTING: MFR: #				
	DELIVERY ARO: /DAYS				
34	6' x 8" x 3/4" - Hole size: 3/4"	50	NO BID	\$0.00	
	QUOTING: MFR: #				
	DELIVERY ARO: /DAYS				
35	7' x 8" x 1" - Hole size: 3/4"	20	NO BID	\$0.00	
	QUOTING: MFR: #				
	DELIVERY ARO: /DAYS				
36	7' x 8" x 1" - Hole size: 3/4"	30	NO BID	\$0.00	
	QUOTING: MFR: #				
	DELIVERY ARO: /DAYS				
37	7' x 8" x 1" - Hole size: 5/8"	250	NO BID	\$0.00	
	QUOTING: MFR: #				
	DELIVERY ARO: /DAYS				
38	7' x 8" 3/4" - Hole size: 3/4"	584	NO BID	\$0.00	
	QUOTING: MFR: #				
	DELIVERY ARO: /DAYS				
39	7' x 8" x 3/4" - Hole size: 5/8"	604	NO BID	\$0.00	
	QUOTING: MFR: #				
	DELIVERY ARO: /DAYS				
40	7' x 8" x 3/4" - Hole size: 5/8"	120	NO BID	\$0.00	
	QUOTING: MFR: #				
	DELIVERY ARO: /DAYS				
41	7' x 8" x 3/4" - Hole size: 3/4"	956	NO BID	\$0.00	
	QUOTING: MFR: #				
	DELIVERY ARO: /DAYS				
42	7' x 8" x 3/4" - Hole size: 5/8"	448	NO BID	\$0.00	
	QUOTING: MFR: #				
	DELIVERY ARO: /DAYS				
43	7' x 8" x 5/8" - Hole size: 3/4"	48	NO BID	\$0.00	
	QUOTING: MFR: #				
	DELIVERY ARO: /DAYS				
44	7' x 8" x 5/8" - Hole size: 5/8"	36	NO BID	\$0.00	
	QUOTING: MFR: #				
	DELIVERY ARO: /DAYS				
45	8' x 8" x 1" - Hole size: 3/4"	80	NO BID	\$0.00	
	QUOTING: MFR: #				
	DELIVERY ARO: /DAYS				
46	8' x 8" x 1" - Hole size: 3/4"	50	NO BID	\$0.00	
	QUOTING: MFR: #				
	DELIVERY ARO: /DAYS				
47	8' x 8" x 3/4" - Hole size: 3/4"	40	NO BID	\$0.00	
	QUOTING: MFR: #				
	DELIVERY ARO: /DAYS				
48	8' x 8" x 3/4" - Hole size: 3/4"	20	NO BID	\$0.00	
	QUOTING: MFR: #				
	DELIVERY ARO: /DAYS				
49	8' x 8" x 3/4" - Hole size: 3/4"	300	NO BID	\$0.00	
	QUOTING: MFR: #				
	DELIVERY ARO: /DAYS				

50	9' x 8" x 3/4" - Hole size: 5/8"		23	NO BID	\$0.00		
	QUOTING: MFR: #						
	DELIVERY ARO: /DAYS						
51	9' x 8" x 5/8" - Hole size: 5/8"		1	NO BID	\$0.00		
	QUOTING: MFR: #						
	DELIVERY ARO: /DAYS						
52	10' x 8" x 1" - Hole size: 5/8"		4	NO BID	\$0.00		
	QUOTING: MFR: #						
	DELIVERY ARO: /DAYS						
53	12' x 6" x 3/4" - Hole size: 5/8"		10	NO BID	\$0.00		
	QUOTING: MFR: #						
	DELIVERY ARO: /DAYS						
54	12' x 8" x 3/4" - Hole size: 5/8"		281	NO BID	\$0.00		
	QUOTING: MFR: #						
	DELIVERY ARO: /DAYS						
55	12' x 8" x 1" - Hole size: 5/8"		4	NO BID	\$0.00		
	QUOTING: MFR: #						
	DELIVERY ARO: /DAYS						
56	12' x 8" x 1" - Hole size: 3/4"		10	NO BID	\$0.00		
	QUOTING: MFR: #						
	DELIVERY ARO: /DAYS						
57	14' x 8" x 3/4" - Hole size: 5/8"		60	NO BID	\$0.00		
	QUOTING: MFR: #						
	DELIVERY ARO: /DAYS						
						FOB Destination \$0.00	Recycled Content
	ALASKA					ESTIMATED UNIT PRICE	TOTAL
	Dual Carbide Insert Blades					QUANTITY	
1	3' x 5" x 7/8" - Hole size: 5/8"		80	NO BID	\$0.00		
	QUOTING: MFR: #						
	DELIVERY ARO: /DAYS						
2	3' x 5" x 7/8" - Hole size: 3/4"		2	NO BID	\$0.00		
	QUOTING: MFR: #						
	DELIVERY ARO: /DAYS						
3	3' x 6" x 3/4" - Hole size: 5/8"		137	NO BID	\$0.00		
	QUOTING: MFR: #						
	DELIVERY ARO: /DAYS						
4	3' x 6" x 7/8" - Hole size: 5/8"		46	NO BID	\$0.00		
	QUOTING: MFR: #						
	DELIVERY ARO: /DAYS						
5	3' x 6" x 7/8" - Hole size: 3/4"		64	NO BID	\$0.00		
	QUOTING: MFR: #						
	DELIVERY ARO: /DAYS						
6	3' x 8" x 7/8" - Hole size: 5/8"		68	NO BID	\$0.00		
	QUOTING: MFR: #						
	DELIVERY ARO: /DAYS						
7	3' x 8" x 1" - Hole size: 5/8"		4	NO BID	\$0.00		
	QUOTING: MFR: #						
	DELIVERY ARO: /DAYS						
8	3' x 8" x 1" - Hole size: 3/4"		30	NO BID	\$0.00		
	QUOTING: MFR: #						
	DELIVERY ARO: /DAYS						
9	4' x 5" x 1" - Hole size: 5/8"		4	NO BID	\$0.00		
	QUOTING: MFR: #						
	DELIVERY ARO: /DAYS						
10	4' x 5" x 3/4" - Hole size: 3/4"		6	NO BID	\$0.00		
	QUOTING: MFR: #						
	DELIVERY ARO: /DAYS						
11	4' x 5" x 3/4" - Hole size: 5/8"		6	NO BID	\$0.00		
	QUOTING: MFR: #						
	DELIVERY ARO: /DAYS						
12	4' x 5" x 7/8" - Hole size: 5/8"		135	NO BID	\$0.00		
	QUOTING: MFR: #						
	DELIVERY ARO: /DAYS						
13	4' x 5" x 7/8" - Hole size: 3/4"		16	NO BID	\$0.00		
	QUOTING: MFR: #						
	DELIVERY ARO: /DAYS						
14	4' x 6" x 3/4" - Hole size: 5/8"		162	NO BID	\$0.00		
	QUOTING: MFR: #						
	DELIVERY ARO: /DAYS						
15	4' x 6" x 3/4" - Hole size: 3/4"		15	NO BID	\$0.00		
	QUOTING: MFR: #						
	DELIVERY ARO: /DAYS						
16	4' x 6" x 7/8" - Hole size: 3/4"		477	NO BID	\$0.00		
	QUOTING: MFR: #						
	DELIVERY ARO: /DAYS						
17	4' x 6" x 7/8" - Hole size: 5/8"		316	NO BID	\$0.00		
	QUOTING: MFR: #						
	DELIVERY ARO: /DAYS						
18	4' x 8" x 1" - Hole size: 5/8"		4	NO BID	\$0.00		
	QUOTING: MFR: #						
	DELIVERY ARO: /DAYS						
19	4' x 8" x 1" - Hole size: 5/8"		40	NO BID	\$0.00		
	QUOTING: MFR: #						
	DELIVERY ARO: /DAYS						
20	4' x 8" x 1" - Hole size: 3/4"		50	NO BID	\$0.00		
	QUOTING: MFR: #						
	DELIVERY ARO: /DAYS						
21	4' x 8" x 1" - Hole size: 3/4"		330	NO BID	\$0.00		
	QUOTING: MFR: #						
	DELIVERY ARO: /DAYS						
22	4' x 8" x 3/4" - Hole size: 3/4"		15	NO BID	\$0.00		
	QUOTING: MFR: #						
	DELIVERY ARO: /DAYS						

23	4' x 8" x 3/4" - Hole size: 5/8"	388	NO BID	\$0.00		
	QUOTING: MFR: #					
	DELIVERY ARO: /DAYS					
24	4' x 8" x 7/8" - Hole size: 5/8"	213	NO BID	\$0.00		
	QUOTING: MFR: #					
	DELIVERY ARO: /DAYS					
25	4' x 10" x 1" - Hole size: 3/4"	90	NO BID	\$0.00		
	QUOTING: MFR: #					
	DELIVERY ARO: /DAYS					
26	5' x 6" x 3/4" - Hole size: 5/8"	2	NO BID	\$0.00		
	QUOTING: MFR: #					
	DELIVERY ARO: /DAYS					
27	5' x 6" x 7/8" - Hole size: 3/4"	2	NO BID	\$0.00		
	QUOTING: MFR: #					
	DELIVERY ARO: /DAYS					
28	5' x 6" x 7/8" - Hole size: 5/8"	8	NO BID	\$0.00		
	QUOTING: MFR: #					
	DELIVERY ARO: /DAYS					
29	6' x 6" x 1" - Hole size: 5/8"	54	NO BID	\$0.00		
	QUOTING: MFR: #					
	DELIVERY ARO: /DAYS					
30	6' x 8" x 3/4" - Hole size: 5/8"	1,818	NO BID	\$0.00		
	QUOTING: MFR: #					
	DELIVERY ARO: /DAYS					
31	6' x 8" x 3/4" - Hole size: 5/8"	398	NO BID	\$0.00		
	QUOTING: MFR: #					
	DELIVERY ARO: /DAYS					
32	6' x 8" x 3/4" - Hole size: 3/4"	100	NO BID	\$0.00		
	QUOTING: MFR: #					
	DELIVERY ARO: /DAYS					
33	6' x 8" x 3/4" - Hole size: 5/8"	100	NO BID	\$0.00		
	QUOTING: MFR: #					
	DELIVERY ARO: /DAYS					
34	6' x 8" x 3/4" - Hole size: 3/4"	50	NO BID	\$0.00		
	QUOTING: MFR: #					
	DELIVERY ARO: /DAYS					
35	7' x 8" x 1" - Hole size: 3/4"	20	NO BID	\$0.00		
	QUOTING: MFR: #					
	DELIVERY ARO: /DAYS					
36	7' x 8" x 1" - Hole size: 3/4"	30	NO BID	\$0.00		
	QUOTING: MFR: #					
	DELIVERY ARO: /DAYS					
37	7' x 8" x 1" - Hole size: 5/8"	250	NO BID	\$0.00		
	QUOTING: MFR: #					
	DELIVERY ARO: /DAYS					
38	7' x 8" 3/4" - Hole size: 3/4"	584	NO BID	\$0.00		
	QUOTING: MFR: #					
	DELIVERY ARO: /DAYS					
39	7' x 8" x 3/4" - Hole size: 5/8"	604	NO BID	\$0.00		
	QUOTING: MFR: #					
	DELIVERY ARO: /DAYS					
40	7' x 8" x 3/4" - Hole size: 5/8"	120	NO BID	\$0.00		
	QUOTING: MFR: #					
	DELIVERY ARO: /DAYS					
41	7' x 8" x 3/4" - Hole size: 3/4"	956	NO BID	\$0.00		
	QUOTING: MFR: #					
	DELIVERY ARO: /DAYS					
42	7' x 8" x 3/4" - Hole size: 5/8"	448	NO BID	\$0.00		
	QUOTING: MFR: #					
	DELIVERY ARO: /DAYS					
43	7' x 8" x 5/8" - Hole size: 3/4"	48	NO BID	\$0.00		
	QUOTING: MFR: #					
	DELIVERY ARO: /DAYS					
44	7' x 8" x 5/8" - Hole size: 5/8"	36	NO BID	\$0.00		
	QUOTING: MFR: #					
	DELIVERY ARO: /DAYS					
45	8' x 8" x 1" - Hole size: 3/4"	80	NO BID	\$0.00		
	QUOTING: MFR: #					
	DELIVERY ARO: /DAYS					
46	8' x 8" x 1" - Hole size: 3/4"	50	NO BID	\$0.00		
	QUOTING: MFR: #					
	DELIVERY ARO: /DAYS					
47	8' x 8" x 3/4" - Hole size: 3/4"	40	NO BID	\$0.00		
	QUOTING: MFR: #					
	DELIVERY ARO: /DAYS					
48	8' x 8" x 3/4" - Hole size: 3/4"	20	NO BID	\$0.00		
	QUOTING: MFR: #					
	DELIVERY ARO: /DAYS					
49	8' x 8" x 3/4" - Hole size: 3/4"	300	NO BID	\$0.00		
	QUOTING: MFR: #					
	DELIVERY ARO: /DAYS					
50	9' x 8" x 3/4" - Hole size: 5/8"	23	NO BID	\$0.00		
	QUOTING: MFR: #					
	DELIVERY ARO: /DAYS					
51	9' x 8" x 5/8" - Hole size: 5/8"	1	NO BID	\$0.00		
	QUOTING: MFR: #					
	DELIVERY ARO: /DAYS					
52	10' x 8" x 1" - Hole size: 5/8"	4	NO BID	\$0.00		
	QUOTING: MFR: #					
	DELIVERY ARO: /DAYS					
53	12' x 6" x 3/4" - Hole size: 5/8"	10	NO BID	\$0.00		
	QUOTING: MFR: #					

	DELIVERY ARO: _____/DAYS					
54	12' x 8" x 3/4" - Hole size: 5/8"	281	NO BID	\$0.00		
	QUOTING: MFR: _____ #					
	DELIVERY ARO: _____/DAYS					
55	12' x 8" x 1" - Hole size: 5/8"	4	NO BID	\$0.00		
	QUOTING: MFR: _____ #					
	DELIVERY ARO: _____/DAYS					
56	12' x 8" x 1" - Hole size: 3/4"	10	NO BID	\$0.00		
	QUOTING: MFR: _____ #					
	DELIVERY ARO: _____/DAYS					
57	14' x 8" x 3/4" - Hole size: 5/8"	60	NO BID	\$0.00		
	QUOTING: MFR: _____ #					
	DELIVERY ARO: _____/DAYS					
	Brand Specific: Caterpillar Inc. Part Number 109-3124 (No substitutions)					
58	14' x 8" x 3/4" - Hole size: 5/8"	300	NO BID	\$0.00		
	QUOTING: MFR: _____ #					
	DELIVERY ARO: _____/DAYS					
State:	NEBRASKA	ESTIMATED QUANTITY	FOB DESTINATION UNIT PRICE	TOTAL	RECYCLED CONTENT	POST CONSUMER
	1-1/2" Gauge					
	36" x 6" x 3/4" Tungsten Carbide Blade	1,000	\$120.72	\$120,720.00		90%
	QUOTING: MFR: _____ #					
	DELIVERY ARO: _____/DAYS					
	48" x 6" x 3/4" Tungsten Carbide Blade	3,000	\$160.96	\$482,880.00		90%
	QUOTING: MFR: _____ #					
	DELIVERY ARO: _____/DAYS					
	36" x 5" x 3/4" Thngsten Carbide Blade	300	\$120.72	\$36,216.00		90%
	QUOTING: MFR: _____ #					
	DELIVERY ARO: _____/DAYS					
	48" x 5" x 3/4" Thngsten Carbide Blade	600	\$160.96	\$96,576.00		90%
	QUOTING: MFR: _____ #					
	DELIVERY ARO: _____/DAYS					
	High Carbon (3-3-12-12)1-1/2" gauge					
	5' x 6" x 1/2" Cover Blade - Black Cat #PBA4606049 or approved equal	300	\$32.38	\$9,714.00		90%
	QUOTING: MFR: _____ #					
	DELIVERY ARO: _____/DAYS					
	6' x 6" x 1/2" Cover Blade - Black Cat #PBA4607249 or approved equal	1,500	38.86	\$58,290.00		90%
	QUOTING: MFR: _____ #					
	DELIVERY ARO: _____/DAYS					
	Thru Hardened Grader Blade					
	7' x 8" x 3/4" Grader Blade	1,000	107.45	\$107,450.00		90%
	QUOTING: MFR: _____ #					
	DELIVERY ARO: _____/DAYS					
	Flexible Plow blades & Guards					
	Joma 6000 SYS-JM11 Initial set up	35	NO BID	\$0.00		
	QUOTING: MFR: _____ #					
	DELIVERY ARO: _____/DAYS					
	Joma 6000 SYS-JM12 Initial set up	50	NO BID	\$0.00		
	QUOTING: MFR: _____ #					
	DELIVERY ARO: _____/DAYS					
	Joma 6000 SYS-JMR11 replacement set up	35	NO BID	\$0.00		
	QUOTING: MFR: _____ #					
	DELIVERY ARO: _____/DAYS					
	Joma 6000 SYS-JMR12 replacement set up	50	NO BID	\$0.00		
	QUOTING: MFR: _____ #					
	DELIVERY ARO: _____/DAYS					
	Joma 6000 JM20315 3' Blade	50	NO BID	\$0.00		
	QUOTING: MFR: _____ #					
	DELIVERY ARO: _____/DAYS					
	Jome 6000 JM20415 4' Blade	100	NO BID	\$0.00		
	QUOTING: MFR: _____ #					
	DELIVERY ARO: _____/DAYS					
	Curb Runner universal Winter CR463U	100	NO BID	\$0.00		
	QUOTING: MFR: _____ #					
	DELIVERY ARO: _____/DAYS					
	Plow guard 6"x 21" x 1-1/8" Winter PS6412E	1,500	NO BID	\$0.00		
	QUOTING: MFR: _____ #					
	DELIVERY ARO: _____/DAYS					
	Plow Systems					
	SYS-BBX11FC Block buster Extreem 11'	20	NO BID	\$0.00		
	QUOTING: MFR: _____ #					
	DELIVERY ARO: _____/DAYS					
	SYS-BBX12FC Block buster Extreem 12'	30	NO BID	\$0.00		
	QUOTING: MFR: _____ #					
	DELIVERY ARO: _____/DAYS					
	Kuper Tuca SX wave 3' Blade	20	NO BID	\$0.00		
	QUOTING: MFR: _____ #					
	DELIVERY ARO: _____/DAYS					
	Kuper Tuca SX wave 4' Blade	30	NO BID	\$0.00		
	QUOTING: MFR: _____ #					
	DELIVERY ARO: _____/DAYS					
	Ironhawk lake effect PBA-LE11	30	NO BID	\$0.00		
	QUOTING: MFR: _____ #					
	DELIVERY ARO: _____/DAYS					
	Ironhawk lake effect PBA-LE12	30	NO BID	\$0.00		
	QUOTING: MFR: _____ #					
	DELIVERY ARO: _____/DAYS					

State: OTHER BLADES OR BLADE SYSTEMS		ESTIMATE	FOB DESTINATION		RECYCLED	POST
		QUANTITY	UNIT PRICE	TOTAL	CONTENT	CONSUMER
1	6' Plain steel cover blades QUOTING: MFR: <u> Valk Manufacturing </u> # DELIVERY ARO: <u> 30-60 </u> /DAYS	1200	62.19	\$74,628.00		90%
2	QUOTING: MFR: <u> # </u> DELIVERY ARO: <u> /DAYS </u>	100		\$0.00		
3	QUOTING: MFR: <u> # </u> DELIVERY ARO: <u> /DAYS </u>	100		\$0.00		
4	QUOTING: MFR: <u> # </u> DELIVERY ARO: <u> /DAYS </u>	100		\$0.00		
5	QUOTING: MFR: <u> # </u> DELIVERY ARO: <u> /DAYS </u>	100		\$0.00		

State of Vermont

Buildings and General Services
Office of Purchasing & Contracting
109 State St
Montpelier VT 05609-3001
USA

CONTRACT



Vendor ID 0000010383
Valk Manufacturing Co
PO Box 428
New Kingstown PA 17072-0428
USA

Contract ID 0000000000000000000029018		Page 1 of 4
Contract Dates 06/30/2015 to 06/30/2019		Origin CPS
Description: SNOWPLOW BLADE CUTTING EDGES		Contract Maximum \$9,999,990.00
Buyer Name Steven D Smith	Buyer Phone 828-4681	Contract Status Approved

Phone #: 717-766-0711

Line #	Item ID	Item Desc	UOM	Unit Price	Max Qty	Max Amt
1		SNOWPLOW BLADE CUTTING EDGES. CONTACT CONTRACTOR FOR PRICE QUOTE	EA	0.01000	0.00	0.00

BLADES PER THE ATTACHED LIST

STANDARD CONTRACT FOR SNOWPLOWBLADE CUTTING EDGES

1. Parties. This is a contract for services between the State of Vermont, Office of Purchasing and Contracting (hereafter called "State"), and Valk Manufacturing, with the principal place of business in New Kingstown, PA 07072, (hereafter called "Contractor"). Contractor's form of business organization is Corporation. It is the contractor's responsibility to contact the Vermont Department of Taxes to determine if, by law, the contractor is required to have a Vermont Department of Taxes Business Account Number.

2. Subject Matter. The subject matter of this contract is services generally on the subject of Snowplow Blade Cutting Edges.

3. Contract Term. The period of contractor's performance shall begin on June 30, 2015 and end on June 30, 2017, with option to renew for five (5) one year periods.

If the state exercises the option, it will provide written notice to contractor prior to the end of the term. If exercised, the provision of the option letter shall become part of and be incorporated into the original master price agreement. The total duration of this master price agreement, including the exercise of any options, shall not exceed five years.

4. Prior Approvals. If approval by the Attorney General's Office or the Secretary of Administration is required, (under current law, bulletins, and interpretations), neither this contract nor any amendment to it is binding until it has been approved by either or both such persons.

- Approval by the Attorney General's Office is required.
- Approval by the Secretary of Administration is required.
- Approval by the CIO/Commissioner DII is not required.

5. Amendment. This agreement represents the entire agreement between the parties; No changes, modifications, or amendments in the terms and conditions of this contract shall be effective unless reduced to writing, numbered and signed by the duly authorized representative of the State and Contractor.

6. Cancellation. This contract may be canceled by either party by giving written notice at least thirty (30) days in advance.

7. Attachments. This contract consists of 160 pages including the following attachments which are incorporated herein:

- Attachment A - Master Agreement Terms and Conditions
- Attachment B - Payment Provisions
- Attachment B1-Price Schedule
- Attachment C - "Standard State Provisions for Contracts and Grants" a preprinted form (revision date March 1, 2015).
- Attachment D - Snowplow Blade Cutting Edges Detailed Specifications

8. Order of Precedence. Any ambiguity, conflict or inconsistency in the Contract Documents shall be resolved according to the following order of precedence:

- (1) Standard Contract
- (2) Attachment C (Standard Contract Provisions for Contracts and Grants)
- (3) Attachment A
- (4) Attachment D
- (5) Attachment B
- (6) Attachment B1

State of Vermont

Buildings and General Services
Office of Purchasing & Contracting
109 State St
Montpelier VT 05609-3001
USA

CONTRACT



Vendor ID 0000010383
Valk Manufacturing Co
PO Box 428
New Kingstown PA 17072-0428
USA

Contract ID 0000000000000000000029018		Page 2 of 4
Contract Dates 06/30/2015 to 06/30/2019		Origin CPS
Description: SNOWPLOW BLADE CUTTING EDGES		Contract Maximum \$9,999,990.00
Buyer Name Steven D Smith	Buyer Phone 828-4681	Contract Status Approved

Phone #: 717-766-0711

Line #	Item ID	Item Desc	UOM	Unit Price	Max Qty	Max Amt
--------	---------	-----------	-----	------------	---------	---------

CONTRACTOR POC:
Dan Cribari
Sales Manager, Snow Plow Division
Valk Manufacturing Company
plowsales@valkmfg.com
Phone: (717) 766-0711 ext. 122
Fax: (717) 697-6297

STATE OF VERMONT CONTACT:
STEVE SMITH
PURCHASING AGENT
802-828-4681
FAX 802-828-2222
steven.smith@Vermont.gov

QUANTITY: THE ANNUAL VALUE AND QUANTITIES ARE ESTIMATED ONLY BASED ON PRIOR USAGE; ACTUAL PURCHASES MAY BE HIGHER OR LOWER DEPENDING ON THE STATE'S NEEDS. THE CONTRACT MAXIMUM IS NOT REFLECTIVE OF ACTUAL USAGE.

DELIVERY: RESPONSIBILITY FOR PRODUCT DELIVERY REMAINS WITH THE CONTRACTOR UNTIL THE PRODUCT IS PROPERLY DELIVERED AND SIGNED FOR IN ACCORDANCE WITH THE OFFICE OF PURCHASING & CONTRACTING TERMS AND CONDITIONS. SHIPMENTS SHALL BE SECURELY AND PROPERLY PACKED, ACCORDING TO ACCEPTED COMMERCIAL PRACTICES, WITHOUT EXTRA CHARGE FOR PACKING CASES OR OTHER CONTAINERS. SUCH CONTAINERS WILL REMAIN THE PROPERTY OF THE STATE UNLESS OTHERWISE STATED. DELIVERED GOODS THAT DO NOT CONFORM TO THE SPECIFICATIONS OR ARE NOT IN GOOD CONDITION UPON RECEIPT SHALL BE REPLACED PROMPTLY BY THE CONTRACTOR.

PRICING: ALL EQUIPMENT PRICING IS TO INCLUDE F.O.B. DELIVERY TO THE ORDERING FACILITY. NO REQUEST FOR EXTRA DELIVERY COST WILL BE HONORED. ALL EQUIPMENT SHALL BE DELIVERED ASSEMBLED, SERVICED, OILED, AND READY FOR IMMEDIATE USE, UNLESS OTHERWISE REQUESTED BY THE PURCHASING AGENCY.

QUALITY: ALL PRODUCTS PROVIDED UNDER THESE AGREEMENTS WILL BE NEW AND UNUSED, UNLESS OTHERWISE STATED. FACTORY SECONDS OR REMANUFACTURED PRODUCTS WILL NOT BE ACCEPTED UNLESS SPECIFICALLY REQUESTED BY THE PURCHASING AGENCY. ALL PRODUCTS PROVIDED BY THE CONTRACTOR MUST MEET ALL FEDERAL, STATE, AND LOCAL STANDARDS FOR QUALITY AND SAFETY REQUIREMENTS. PRODUCTS NOT MEETING THESE STANDARDS WILL BE DEEMED UNACCEPTABLE AND RETURNED TO THE CONTRACTOR FOR CREDIT AT NO CHARGE TO THE STATE.

METHOD OF ORDERING: PURCHASE ORDERS MUST BE USED TO ORDER ITEMS AVAILABLE UNDER THIS CONTRACT. IF VERBAL ORDERS ARE GIVEN A CONFIRMING PURCHASE ORDER MUST BE ISSUED.

INVOICING: ALL INVOICES ARE TO BE RENDERED BY THE CONTRACTOR ON THE VENDOR'S STANDARD BILLHEAD AND FORWARDED DIRECTLY TO THE INSTITUTION OR AGENCY ORDERING MATERIALS OR SERVICES AND SHALL SPECIFY THE ADDRESS TO WHICH PAYMENTS WILL BE SENT.

CANCELLATION: THE STATE SPECIFICALLY RESERVES THE RIGHT TO CANCEL THE CONTRACT, OR ANY PORTION THEREOF, IF, IN THE OPINION OF ITS COMMISSIONER OF BUILDINGS AND GENERAL SERVICES, THE SERVICES OR MATERIALS SUPPLIED BY THE CONTRACTOR ARE NOT SATISFACTORY OR ARE NOT CONSISTENT WITH THE TERMS OF THE CONTRACT

DEFAULT: IN CASE OF DEFAULT OF THE CONTRACTOR, THE STATE MAY PROCURE THE MATERIALS OR SUPPLIES FROM OTHER SOURCES AND HOLD THE CONTRACTOR RESPONSIBLE FOR ANY EXCESS COST OCCASIONED THEREBY, PROVIDED, THAT IF PUBLIC NECESSITY REQUIRES THE USE OF MATERIALS OR SUPPLIES NOT CONFORMING TO THE SPECIFICATIONS THEY MAY BE ACCEPTED AND PAYMENT THEREFORE SHALL BE MADE AT A PROPER REDUCTION IN PRICE.

CONTRACT TERMS: THIS CONTRACT WILL BE SUBJECT TO REVIEW THROUGHOUT ITS TERM. THE STATE WILL CONSIDER CANCELLATION UPON DISCOVERY THAT A VENDOR IS IN VIOLATION OF ANY PORTION OF THE AGREEMENT, INCLUDING AN INABILITY BY THE VENDOR TO PROVIDE THE PRODUCTS, SUPPORT, AND/OR SERVICE OFFERED IN THEIR RESPONSE.

State of Vermont

Buildings and General Services
Office of Purchasing & Contracting
109 State St
Montpelier VT 05609-3001
USA

CONTRACT



Vendor ID 0000010383
Valk Manufacturing Co
PO Box 428
New Kingstown PA 17072-0428
USA

Contract ID 0000000000000000000029018	Page 3 of 4
Contract Dates 06/30/2015 to 06/30/2019	Origin CPS
Description: SNOWPLOW BLADE CUTTING EDGES	Contract Maximum \$9,999,990.00
Buyer Name Steven D Smith	Buyer Phone 828-4681
Contract Status Approved	

Phone #: 717-766-0711

Line #	Item ID	Item Desc	UOM	Unit Price	Max Qty	Max Amt
--------	---------	-----------	-----	------------	---------	---------

VERMONT STATE COLLEGES: THIS CONTRACT IS ALSO AVAILABLE FOR USE BY THE UNIVERSITY OF VERMONT AND THE VERMONT STATE COLLEGES INC., A SEPARATE CORPORATION, HAVING UNDER ITS JURISDICTION CASTLETON STATE COLLEGE, JOHNSON STATE COLLEGE, LYNDON STATE COLLEGE, COMMUNITY COLLEGE OF VERMONT, AND THE VERMONT TECHNICAL COLLEGE.

TOWNS AND SCHOOLS OF THE STATE OF VERMONT: AT THE BIDDER'S ELECTION POLITICAL SUBDIVISIONS AND INDEPENDENT COLLEGES OF THE STATE MAY PARTICIPATE IN STATE CONTRACTS AT THE SAME PRICES, TERMS AND CONDITIONS. ITEMS FURNISHED TO POLITICAL SUBDIVISIONS AND INDEPENDENT COLLEGES WILL BE BILLED DIRECTLY TO AND PAID FOR BY THE POLITICAL SUBDIVISIONS OR INDEPENDENT COLLEGES AND NEITHER THE STATE NOR ITS COMMISSIONER OF BUILDINGS AND GENERAL SERVICES PERSONALLY OR OFFICIALLY ASSUMES ANY RESPONSIBILITY FOR THESE PAYMENTS.

AGENCIES & DEPARTMENTS ARE REQUESTED TO ADVISE THE PURCHASING AGENT AT ONCE OF THE FAILURE ON THE PART OF THE CONTRACTOR TO FULFILL ANY OF THE TERMS OR CONDITIONS OF THIS CONTRACT.

PLEASE REFER TO THE ASSIGNED CONTRACT NUMBER/PURCHASE ORDER # ON ALL CORRESPONDENCE, DELIVERY DOCUMENTS AND INVOICES.

APRIL 7, 2017
AMENDMENT #01 - TO EXTEND CONTRACT FOR A ONE YEAR PERIOD AT THE SAME PRICES, TERMS AND CONDITIONS.

JUNE 7, 2018
AMENDMENT #02 - TO EXTEND CONTRACT FOR A ONE YEAR PERIOD AT THE SAME PRICES, TERMS AND CONDITIONS WITH THE FOLLOWING EXCEPTIONS:

1). PRICING: DUE TO TARIFFS ON IMPORTED STEEL CURRENTLY IN EFFECT, PLOW BLADE PRICING IS HEREBY REMOVED FROM THE ATTACHED PRODUCT LIST. ORDERING ENTITIES ARE TO REQUEST A QUOTE FROM CONTRACTOR FOR PRICING IN EFFECT AT TIME OF ORDER.

ATTACHMENT C: STANDARD STATE PROVISIONS FOR CONTRACTS AND GRANTS REVISED DECEMBER 15, 2017 IS INCORPORATED INTO THE CONTRACT.

CONTRACTOR CERTIFIES UNDER THE PAINS AND PENALTIES OF PERJURY THAT, AS OF THE DATE THIS CONTRACT AMENDMENT IS SIGNED, CONTRACTOR IS IN GOOD STANDING WITH RESPECT TO, OR IN FULL COMPLIANCE WITH A PLAN TO PAY ANY AND ALL TAXES DUE THE STATE OF VERMONT

CERTIFICATION REGARDING SUSPENSION OR DEBARMENT. CONTRACTOR CERTIFIES UNDER THE PAINS AND PENALTIES OF PERJURY THAT, AS OF THIS DATE THIS CONTRACT AMENDMENT IS SIGNED, NEITHER PARTY NO PARTY'S PRINCIPALS (OFFICERS, DIRECTORS, OWNERS, OR PARTNERS) ARE PRESENTLY DEBARRED, SUSPENDED, PROPOSED FOR DEBARMENT, DECLARED INELIGIBLE OR EXCLUDED FROM PARTICIPATION IN FEDERAL PROGRAMS, OR PROGRAMS SUPPORTED IN WHOLE OR IN PART BY FEDERAL FUNDS.

PARTY FURTHER CERTIFIES UNDER PAINS AND PENALTIES OF PERJURY THAT, AS OF THE DATE THIS AGREEMENT IS SIGNED, PARTY IS NOT PRESENTLY DEBARRED, SUSPENDED, NOR NAMED ON THE STATE'S DEBARMENT LIST AT: [HTTP://BGS.VERMONT.GOV/PURCHASING/DEBARMENT](http://BGS.VERMONT.GOV/PURCHASING/DEBARMENT) .

CHILD SUPPORT (APPLICABLE TO NATURAL PERSONS ONLY; NOT APPLICABLE TO CORPORATIONS, PARTNERSHIPS OR LLCs): CONTRACTOR IS UNDER NO OBLIGATION TO PAY CHILD SUPPORT OR IS IN GOOD STANDING WITH RESPECT TO OR IN FULL COMPLIANCE WITH A PLAN TO PAY ANY AND ALL CHILD SUPPORT PAYABLE UNDER A SUPPORT ORDER AS OF THE DATE OF THIS AMENDMENT.

State of Vermont

Buildings and General Services
Office of Purchasing & Contracting
109 State St
Montpelier VT 05609-3001
USA

CONTRACT



Vendor ID 0000010383
Valk Manufacturing Co
PO Box 428
New Kingstown PA 17072-0428
USA

Contract ID	000000000000000000029018	Page	4 of 4
Contract Dates	06/30/2015 to 06/30/2019	Origin	CPS
Description:	SNOWPLOW BLADE CUTTING EDGES	Contract Maximum	\$9,999,990.00
Buyer Name	Steven D Smith	Buyer Phone	828-4681
		Contract Status	Approved

Phone #: 717-766-0711

Line #	Item ID	Item Desc	UOM	Unit Price	Max Qty	Max Amt
WE THE UNDERSIGNED PARTIES AGREE TO BE BOUND BY THIS CONTRACT						

By the STATE of VERMONT

Date: _____
Signature: e-Signed by Christopher Cole
on 2018-11-07 16:25:12 GMT
Name: Christopher Cole

Title: BGS Commissioner
Email: _____

By the CONTRACTOR

Date: 11/6/18
Signature:
Name: Robert P. Lang

Title: Vice President
Email: rlang@valkmfg.com

	A	B	C
1		VALK MANUFACTURING	
2			
3			
4			
5			
6	STATE	VERMONT	Post Consum
7	Item #	DESCRIPTION	Content
8		BLADES	
9	1	6" top punched 44" carbide blade, 6 hole	90%
10		QUOTING: MFR: <u> Valk Manufacturing Company </u> #	
11		DELIVERY ARO: <u> 60-120 </u> /DAYS	
12			
13	2	6" top punched 44" carbide blade, 5 hole	90%
14		QUOTING: MFR: <u> Valk Manufacturing Company </u> #	
15		DELIVERY ARO: <u> 60-120 </u> /DAYS	
16			
17	3	6" top punched 28" carbide blade, 3 hole	90%
18		QUOTING: MFR: <u> Valk Manufacturing Company </u> #	
19		DELIVERY ARO: <u> 60-120 </u> /DAYS	
20			
21	4	6" top punched 72" carbide blade, 9 hole	90%
22		QUOTING: MFR: <u> Valk Manufacturing Company </u> #	
23		DELIVERY ARO: <u> 60-120 </u> /DAYS	
24			
25		6" top punched 20" carbide blade, 3 hole, right or left	
26			
27	5	Right hand blade	90%
28		QUOTING: MFR: <u> Valk Manufacturing Company </u> #	
29		DELIVERY ARO: <u> 60-120 </u> DAYS	
30			
31	6	Left hand blade	90%
32		QUOTING: MFR: <u> Valk Manufacturing Company </u> #	
33		DELIVERY ARO: <u> 60-120 </u> /DAYS	
34			
35		6" top punched 36" carbide blade, 5 hole, right or left	
36			
37	7	Right hand blade	90%
38		QUOTING: MFR: <u> Valk Manufacturing Company </u> #	
39		DELIVERY ARO: <u> 60-120 </u> /DAYS	
40			
41	8	Left hand blade	90%
42		QUOTING: MFR: <u> Valk Manufacturing Company </u> #	
43		DELIVERY ARO: <u> 60-120 </u> /DAYS	
44			
45	9	6" top punched 48" carbide grader blade, 6 hole	90%
46		QUOTING: MFR: <u> Valk Manufacturing Company </u> #	
47		DELIVERY ARO: <u> 60-120 </u> /DAYS	
48			
49	10	6" top punched 36" carbide blade, 5 holes (12")	90%
50		QUOTING: MFR: <u> Valk Manufacturing Company </u> #	
51		DELIVERY ARO: <u> 60-120 </u> /DAYS	
52			
53	11	6" top punched 48" carbide blade, 6 holes (12")	90%
54		QUOTING: MFR: <u> Valk Manufacturing Company </u> #	
55		DELIVERY ARO: <u> 60-120 </u> /DAYS	
56			
57	12	6" top punched 84" carbide JD grader blade, 15 hole	90%
58		QUOTING: MFR: <u> Valk Manufacturing Company </u> #	
59		DELIVERY ARO: <u> 60-120 </u>	
60			
61	13	8" top punched 60" hardened steel blade, 8 hole	90%
62		QUOTING: MFR: # <u> Valk Manufacturing Company </u>	
63		DELIVERY ARO: <u> 30-60 </u> /DAYS	
64			
65	14	8" top punched 72" hardened steel blade, 9 hole	90%
66		QUOTING: MFR: <u> Valk Manufacturing Company </u> #	
67		DELIVERY ARO: <u> 30-60 </u> /DAYS	

	A	B	C
68			
69	15	8" top punched 60" harden steel blade, 7 hole (12")	90%
70		QUOTING: MFR: ___Valk Manufacturing Company_____#	
71		DELIVERY ARO: ___30-60_____/DAYS	
72			
73	16	8" top punched 72" hardened steel blade, 8 hole (12")	90%
74		QUOTING: MFR: ___Valk Manufacturing Company_____#	
75		DELIVERY ARO: ___30-60_____/DAYS	
76			
77	17	8" top punched 84" hardened steel blade, 15 hole	90%
78		QUOTING: MFR: ___Valk Manufacturing Company_____#	
79		DELIVERY ARO: ___30-60_____/DAYS	
80			
81	18	8" center punched 11' regular steel blade, 17 hole	90%
82		QUOTING: MFR: ___Valk Manufacturing Company_____#	
83		DELIVERY ARO: ___30-60_____/DAYS	
84			
85	19	6" top punched 11' regular steel blade, 17 hole	90%
86		QUOTING: MFR: ___Valk Manufacturing Company_____#	
87		DELIVERY ARO: ___30-60_____/DAYS	
88			
89	20	17 hole, 8" TP, 11' plow blade	90%
90		QUOTING: MFR: ___Valk Manufacturing Company_____#	
91		DELIVERY ARO: ___30-60_____/DAYS	
92			
93	21	14 hole, 6" TP, 12' plow blade	90%
94		QUOTING: MFR: ___Valk Manufacturing Company_____#	
95		DELIVERY ARO: ___30-60_____/DAYS	
96			
97	22	6" top punched 11' regular steel blade, 13 hole (12")	90%
98		QUOTING: MFR: ___Valk Manufacturing Company_____#	
99		DELIVERY ARO: ___30-60_____/DAYS	
100			
101	23	6" top punched 10' regular steel blade, 12 holes (12")	90%
102		QUOTING: MFR: ___Valk Manufacturing Company_____#	
103		DELIVERY ARO: ___30-60_____/DAYS	
104			
105	24	6" top punched 9' regular steel blade, 11 holes (12")	90%
106		QUOTING: MFR: ___Valk Manufacturing Company_____#	
107		DELIVERY ARO: ___30-60_____/DAYS	
108			
109	25	Wing blade, 15 hole, 6" TP RSWB-15	90%
110		QUOTING: MFR: ___Valk Manufacturing Company_____#	
111		DELIVERY ARO: ___30-60_____/DAYS	
112			
113	26	8" center punched 9' regular steel blade, 14 hole	90%
114		QUOTING: MFR: ___Valk Manufacturing Company_____#	
115		DELIVERY ARO: ___30-60_____/DAYS	
116			
117	27	6" top punched 9' regular steel blade, 14 hole	90%
118		QUOTING: MFR: ___Valk Manufacturing Company_____#	90%
119		DELIVERY ARO: ___30-60_____/DAYS	90%
120			90%
121	28	8" top punched 9' regular steel blade, 14 hole	90%
122		QUOTING: MFR: ___Valk Manufacturing Company_____#	
123		DELIVERY ARO: ___30-60_____/DAYS	
124			
125	29	15 hole, 6" TP 10' wing blade	90%
126		QUOTING: MFR: ___Valk Manufacturing Company_____#	
127		DELIVERY ARO: ___30-60_____/DAYS	
128			
129	30	72" Grader blade section, 6"	90%
130		QUOTING: MFR: Valk Manufacturing Company_____#	
131		DELIVERY ARO: ___30-60_____/DAYS	
132			
133	31	72" Grader blade section, 8"	90%
134		QUOTING: MFR: ___Valk Manufacturing Company_____#	

	A	B	C
135		DELIVERY ARO: <u>30-60</u> /DAYS	
136			

	A	B	C
137	32	72" Serrated grader blade section, 6"	90%
138		QUOTING: MFR: __Valk Manufacturing Company_____ #	
139		DELIVERY ARO: ___30-60___/DAYS	
140			
141	33	8" center punched 12' regular steel blade, 18 hole	90%
142		QUOTING: MFR: __Valk Manufacturing Company_____ #	
143		DELIVERY ARO: ___30-60___/DAYS	
144			
145	34	11' Cat 120 grader wing, 6" TP	90%
146		QUOTING: MFR: __Valk Manufacturing Company_____ #	
147		DELIVERY ARO: ___30-60___/DAYS	
148			
149	35	John Deere 544E bucket cutting edge	90%
150		QUOTING: MFR: __Valk Manufacturing Company_____ #	
151		DELIVERY ARO: ___30-60___/DAYS	
152			
153	36	John Deere 544G & H bucket cutting edge set	90%
154		QUOTING: MFR: __Valk Manufacturing Company_____ #	
155		DELIVERY ARO: ___30-60___/DAYS	
156			
157	37	End section only - each	90%
158		QUOTING: MFR: __Valk Manufacturing Company_____ #	
159		DELIVERY ARO: ___30-60___/DAYS	
160			
161	38	John Deere 310 & 410 bucket cutting edge	90%
162		QUOTING: MFR: __Valk Manufacturing Company_____ #	
163		DELIVERY ARO: ___30-60___/DAYS	
164			
165	39	Craig snow bucket edge	90%
166		QUOTING: MFR: __Valk Manufacturing Company_____ #	
167		DELIVERY ARO: ___30-60___/DAYS	
168			
169	40	7-1/2' Fisher plow blade 6" TP (1/2x6x90)	90%
170		QUOTING: MFR: __Valk Manufacturing Company_____ #	
171		DELIVERY ARO: ___30-60___ DAYS	
172			
173	41	6" top punch 8' regular steel blade, 8 hole Fisher Plow	90%
174		QUOTING: MFR: __Valk Manufacturing Company_____ #	
175		DELIVERY ARO: ___30-60___ DAYS	
176			
177	42	120" Viking runway plow section 8" CP	90%
178		QUOTING: MFR: __Valk Manufacturing Company_____ #	
179		DELIVERY ARO: ___30-60___ DAYS	
180			
181	43	40E: 5 holes at 8" center-center starting at 4" from each end, and 2" from top	90%
182		QUOTING: MFR: __Valk Manufacturing Company_____ #	
183		DELIVERY ARO: ___60-120___ DAYS	
184			
185	44	Section 40C: Carbide Blade for 120" blade. 3/4" x 6" x 40" (20 degrees)	90%
186		QUOTING: MFR: __Valk Manufacturing Company_____ #	
187		DELIVERY ARO: ___60-120___ DAYS	
188			
189	STATE	MASSACHUSETTS	
190			
191	1	PLOW BLADE 5/8"x 6' x 144" SHP	90%
192		QUOTING: MFR: __Valk Manufacturing Company_____ #	
193		DELIVERY ARO: ___30-60___ DAYS	
194			
195	2	PLOW BLADE 5/8" x 6' x 168" SHP	90%
196		QUOTING: MFR: __Valk Manufacturing Company_____ #	
197		DELIVERY ARO: ___30-60___ DAYS	
198			
199	3	PLOW BLADE 1/2" x 6"x 132" SHP	90%
200		QUOTING: MFR: __Valk Manufacturing Company_____ #	
201		DELIVERY ARO: ___30-60___ DAYS	
202			
203	4	PLOW BLADE 1/2" x 6"x 120" SHP	90%

	A	B	C
204		QUOTING: MFR: <u> Valk Manufacturing Company </u> #	
205		DELIVERY ARO: <u> 30-60 </u> /DAYS	
206			
207	5	PLOW BLADE CARBIDE 3/4" x 6" x 3'	90%
208		QUOTING: MFR: <u> Valk Manufacturing Company </u> #	
209		DELIVERY ARO: <u> 60-120 </u> /DAYS	
210			
211	6	PLOW BLADE CARBIDE 3/4" x 6" x 4'	90%
212		QUOTING: MFR: <u> Valk Manufacturing Company </u> #	
213		DELIVERY ARO: <u> 60-120 </u> /DAYS	
214			
215	7	Carbide Blade 40C - 3/4" x 6" x 40", 25 Degrees	90%
216		QUOTING: MFR: <u> Valk Manufacturing Company </u> #	
217		DELIVERY ARO: <u> 90-150 </u> /DAYS	
218			
219	8	Carbide Blade 44C - 3/4" x 6" x 44", 25 Degrees	90%
220		QUOTING: MFR: <u> Valk Manufacturing Company </u> #	
221		DELIVERY ARO: <u> 90-150 </u> /DAYS	
222			
223	9	Carbide Blade 44E - 3/4" x 6" x 44", 25 Degrees	90%
224		QUOTING: MFR: <u> Valk Manufacturing Company </u> #	
225		DELIVERY ARO: <u> 90-150 </u> /DAYS	
226			
227	10	Carbide Blade 48", 6" top punched, 6 holes, 12" on center holes, 4 footers	90%
228		QUOTING: MFR: <u> Valk Manufacturing Company </u> #	
229		DELIVERY ARO: <u> 90-150 </u> /DAYS	
230			
231	11	Carbide Blade 36", 6" top punched, 5 holes, 12" on center holes, 3 footers	90%
232		QUOTING: MFR: <u> Valk Manufacturing Company </u> #	
233		DELIVERY ARO: <u> 90-150 </u> /DAYS	
234			
235	12	6" top punched 44" carbide blade, 6 hole	90%
236		QUOTING: MFR: <u> Valk Manufacturing Company </u> #	
237		DELIVERY ARO: <u> 90-150 </u> /DAYS	
238			
239	13	6" top punched 44" carbide blade, 5 hole	90%
240		QUOTING: MFR: <u> Valk Manufacturing Company </u> #	
241		DELIVERY ARO: <u> 90-150 </u> /DAYS	
242			
243	14	6" top punched 28" carbide blade, 3 hole	90%
244		QUOTING: MFR: <u> Valk Manufacturing Company </u> #	
245		DELIVERY ARO: <u> 90-150 </u> /DAYS	
246			
247	15	6" top punched 72" carbide blade, 9 hole	90%
248		QUOTING: MFR: <u> Valk Manufacturing Company </u> #	
249		DELIVERY ARO: <u> 90-150 </u> /DAYS	
250			
251		6" top punched 20" carbide blade, 3 hole, right or left	
252			
253	16	Right hand blade	90%
254		QUOTING: MFR: <u> Valk Manufacturing Company </u> #	
255		DELIVERY ARO: <u> 90-150 </u> /DAYS	
256			
257	17	Left hand blade	90%
258		QUOTING: MFR: <u> Valk Manufacturing Company </u> #	
259		DELIVERY ARO: <u> 90-150 </u> /DAYS	
260			
261	18	6" top punched 48" carbide grader blade, 6 hole	90%
262		QUOTING: MFR: <u> Valk Manufacturing Company </u> #	
263		DELIVERY ARO: <u> 90-150 </u> /DAYS	
264			
265	19	6" top punched 36" carbide blade, 5 holes (12")	90%
266		QUOTING: MFR: <u> Valk Manufacturing Company </u> #	
267		DELIVERY ARO: <u> 90-150 </u> /DAYS	
268			
269	20	6" top punched 48" carbide blade, 6 holes (12")	90%
270		QUOTING: MFR: <u> Valk Manufacturing Company </u> #	

	A	B	C
271		DELIVERY ARO: ___ 90-150 ___ DAYS	
272			
273	21	6" top punched 84" carbide JD grader blade, 15 hole	90%
274		QUOTING: MFR: ___ Valk Manufacturing Company _____ #	
275		DELIVERY ARO: ___ 90-150 ___ DAYS	
276			
277	22	8" top punched 60" hardened steel blade, 8 hole	90%
278		QUOTING: MFR: ___ Valk Manufacturing Company _____ #	
279		DELIVERY ARO: ___ 30-60 ___ DAYS	
280			
281	23	8" top punched 72" hardened steel blade, 9 hole	90%
282		QUOTING: MFR: ___ Valk Manufacturing Company _____ #	
283		DELIVERY ARO: ___ 30-60 ___ DAYS	
284			
285	24	8" top punched 60" harden steel blade, 7 hole (12")	90%
286		QUOTING: MFR: ___ Valk Manufacturing Company _____ #	
287		DELIVERY ARO: ___ 30-60 ___ DAYS	
288			
289	25	8" top punched 72" hardened steel blade, 8 hole (12")	90%
290		QUOTING: MFR: ___ Valk Manufacturing Company _____ #	
291		DELIVERY ARO: ___ 30-60 ___ DAYS	
292			
293	26	8" top punched 84" hardened steel blade, 15 hole	90%
294		QUOTING: MFR: ___ Valk Manufacturing Company _____ #	
295		DELIVERY ARO: ___ 30-60 ___ DAYS	
296			
297	27	8" center punched 11' regular steel blade, 17 hole	90%
298		QUOTING: MFR: ___ Valk Manufacturing Company _____ #	
299		DELIVERY ARO: ___ 30-60 ___ DAYS	
300			
301	28	6" top punched 11' regular steel blade, 17 hole	90%
302		QUOTING: MFR: ___ Valk Manufacturing Company _____ #	
303		DELIVERY ARO: ___ 30-60 ___ DAYS	
304			
305	29	17 hole, 8" TP, 11' plow blade (5/8x8x132)	90%
306		QUOTING: MFR: ___ Valk Manufacturing Company _____ #	
307		DELIVERY ARO: ___ 30-60 ___ DAYS	
308			
309	30	14 hole, 6" TP, 12' plow blade (5/8x6x144)	90%
310		QUOTING: MFR: ___ Valk Manufacturing Company _____ #	
311		DELIVERY ARO: ___ 30-60 ___ DAYS	
312			
313	31	6" top punched 11' regular steel blade, 13 hole (12")	90%
314		QUOTING: MFR: ___ Valk Manufacturing Company _____ #	
315		DELIVERY ARO: ___ 30-60 ___ DAYS	
316			
317	32	6" top punched 10' regular steel blade, 12 holes (12")	90%
318		QUOTING: MFR: ___ Valk Manufacturing Company _____ #	
319		DELIVERY ARO: ___ 30-60 ___ DAYS	
320			
321	33	6" top punched 9' regular steel blade, 11 holes (12")	90%
322		QUOTING: MFR: ___ Valk Manufacturing Company _____ #	
323		DELIVERY ARO: ___ 30-60 ___ DAYS	
324			
325	34	Wing blade, 15 hole, 6" TP RSWB-15	90%
326		QUOTING: MFR: ___ Valk Manufacturing Company _____ #	
327		DELIVERY ARO: ___ 30-60 ___ DAYS	
328			
329	35	8" center punched 9' regular steel blade, 14 hole	90%
330		QUOTING: MFR: ___ Valk Manufacturing Company _____ #	
331		DELIVERY ARO: ___ 30-60 ___ DAYS	
332			
333	36	6" top punched 9' regular steel blade, 14 hole	90%
334		QUOTING: MFR: ___ Valk Manufacturing Company _____ #	
335		DELIVERY ARO: ___ 30-60 ___ DAYS	
336			
337	37	8" top punched 9' regular steel blade, 14 hole	90%

	A	B	C
338		QUOTING: MFR: __Valk Manufacturing Company #	
339		DELIVERY ARO: __30-60__ DAYS	
340			
341	38	15 hole, 6" TP 10' wing blade	90%
342		QUOTING: MFR: __Valk Manufacturing Company #	
343		DELIVERY ARO: __30-60__ DAYS	
344			
345	39	72" Grader blade section, 6"	90%
346		QUOTING: MFR: __Valk Manufacturing Company #	
347		DELIVERY ARO: __30-60__ DAYS	
348			
349	40	72" Grader blade section, 8"	90%
350		QUOTING: MFR: __Valk Manufacturing Company #	
351		DELIVERY ARO: __30-60__ DAYS	
352			
353	41	72" Serrated grader blade section, 6"	90%
354		QUOTING: MFR: __Valk Manufacturing Company #	
355		DELIVERY ARO: __30-60__ DAYS	
356			
357	42	8" center punched 12' regular steel blade, 18 hole	90%
358		QUOTING: MFR: __Valk Manufacturing Company #	
359		DELIVERY ARO: __30-60__ DAYS	
360			
361	43	11' Cat 120 grader wing, 6" TP	90%
362		QUOTING: MFR: __Valk Manufacturing Company #	
363		DELIVERY ARO: __30-60__ DAYS	
364			
365	44	John Deere 544E bucket cutting edge	90%
366		QUOTING: MFR: __Valk Manufacturing Company #	
367		DELIVERY ARO: __30-60__ DAYS	
368			
369	45	John Deere 544G & H bucket cutting edge set	90%
370		QUOTING: MFR: __Valk Manufacturing Company #	
371		DELIVERY ARO: __30-60__ DAYS	
372			
373	46	End section only - each	90%
374		QUOTING: MFR: __Valk Manufacturing Company #	90%
375		DELIVERY ARO: __30-60__ DAYS	90%
376			90%
377	47	John Deere 310 & 410 bucket cutting edge	90%
378		QUOTING: MFR: __Valk Manufacturing Company #	
379		DELIVERY ARO: __30-60__ DAYS	
380			
381	48	Craig snow bucket edge	90%
382		QUOTING: MFR: __Valk Manufacturing Company #	
383		DELIVERY ARO: __30-60__ DAYS	
384			
385	49	7-1/2' Fisher plow blade 6" TP	90%
386		QUOTING: MFR: __Valk Manufacturing Company #	
387		DELIVERY ARO: __30-60__ DAYS	
388			
389	50	6" top punch 8' regular steel blade, 8 hole Fisher Plow	90%
390		QUOTING: MFR: __Valk Manufacturing Company #	
391		DELIVERY ARO: __30-60__ DAYS	
392			
393	51	120" Viking runway plow section 8" CP	90%
394		QUOTING: MFR: __Valk Manufacturing Company #	
395		DELIVERY ARO: __30-60__ DAYS	
396			
397	52	40E: 5 holes at 8" center-center starting at 4" from each end, and 2" from top	90%
398		QUOTING: MFR: __Valk Manufacturing Company #	
399		DELIVERY ARO: __90-150__ DAYS	
400			
401	53	Section 40C: Carbide Blade for 120" blade. 3/4" x 6" x 40" (20 degrees)	90%
402		QUOTING: MFR: __Valk Manufacturing Company #	
403		DELIVERY ARO: __90-150__ DAYS	
404			

	A	B	C
405	54	BLADE-SLUSH CARB 4'	90%
406		QUOTING: MFR: __Valk Manufacturing Company__ #	
407		DELIVERY ARO: __90-150__ /DAYS	
408			
409	55	BLADE-SLUSH CARB 3'	90%
410		QUOTING: MFR: __Valk Manufacturing Company__ #	
411		DELIVERY ARO: __90-150__ /DAYS	
412			
413	56	BLADE-PLOW CARB 3'	90%
414		QUOTING: MFR: __Valk Manufacturing Company__ #	
415		DELIVERY ARO: __90-150__ /DAYS	
416			
417	57	BLADE-PLOW CARB 4'	90%
418		QUOTING: MFR: __Valk Manufacturing Company__ #	
419		DELIVERY ARO: __90-150__ /DAYS	
420			
421	58	BLADE-GRADER 6'; Std. Curved; 3-3-12 punch	90%
422		QUOTING: MFR: __Valk Manufacturing Company__ #	
423		DELIVERY ARO: __30-60__ DAYS	
424			
425	59	BLADE-GRADER SAWTOOTH 6'	90%
426		QUOTING: MFR: __Valk Manufacturing Company__ #	
427		DELIVERY ARO: __30-60__ DAYS	
428			
429	60	BLADE-WING 10' 3-3-12 104 AP	90%
430		QUOTING: MFR: __Valk Manufacturing Company__ #	
431		DELIVERY ARO: __30-60__ DAYS	
432			
433	61	BLADE-WING 11' 3-3-12 102 AP	90%
434		QUOTING: MFR: __Valk Manufacturing Company__ #	
435		DELIVERY ARO: __30-60__ DAYS	
436			
437	62	BLADE-WING 13' 3-3-12 115 AP	90%
438		QUOTING: MFR: __Valk Manufacturing Company__ #	
439		DELIVERY ARO: __30-60__ DAYS	
440			
441	63	BLADE-BUCKET LG CASE 621/621B #L127366	90%
442		QUOTING: MFR: __Valk Manufacturing Company__ #	
443		DELIVERY ARO: __30-60__ DAYS	
444			
445	64	BLADE-BUCKET SM CASE 621/621B #L127367	90%
446		QUOTING: MFR: __Valk Manufacturing Company__ #	
447		DELIVERY ARO: __30-60__ DAYS	
448			
449	65	BLADE-WING EVEREST 1/2X6X9' 3-3-12 107AP	90%
450		QUOTING: MFR: __Valk Manufacturing Company__ #	
451		DELIVERY ARO: __30-60__ DAYS	
452			
453	66	BLADE-WING 12'JD GRADER 3-3-12 113AP	90%
454		QUOTING: MFR: __Valk Manufacturing Company__ #	
455		DELIVERY ARO: __30-60__ DAYS	
456			
457	67	BLADE-BUCKET CASE 580L/SL 10H #112946A1	90%
458		QUOTING: MFR: __Valk Manufacturing Company__ #	
459		DELIVERY ARO: __30-60__ DAYS	
460			
461	68	BLADE-BUCKET CASE 580SM #185506A1	90%
462		QUOTING: MFR: __Valk Manufacturing Company__ #	
463		DELIVERY ARO: __30-60__ DAYS	
464			
465	69	John Deere Loader 444 Ends T146673	90%
466		QUOTING: MFR: __Valk Manufacturing Company__ #	
467		DELIVERY ARO: __30-60__ DAYS	
468			
469	70	John Deere Loader 444 Centers T157311	90%
470		QUOTING: MFR: __Valk Manufacturing Company__ #	
471		DELIVERY ARO: __30-60__ DAYS	

	A	B	C
472			
473	STATE	MAINE	
474			
475	1	Carbide Blade 28C - 3/4" x 6" x 28", 25 Degrees	90%
476		QUOTING: MFR: __Valk Manufacturing Company__ #	
477		DELIVERY ARO: _____60-120_____/DAYS	
478			
479	2	Carbide Blade 40C - 3/4" x 6" x 40", 25 Degrees	90%
480		QUOTING: MFR: __Valk Manufacturing Company__ #	
481		DELIVERY ARO: _____60-120_____/DAYS	
482			
483	3	Carbide Blade 44C - 3/4" x 6" x 44", 25 Degrees	90%
484		QUOTING: MFR: __Valk Manufacturing Company__ #	
485		DELIVERY ARO: _____60-120_____/DAYS	
486			
487	4	Carbide Blade 44E - 3/4" x 6" x 44", 25 Degrees	90%
488		QUOTING: MFR: __Valk Manufacturing Company__ #	
489		DELIVERY ARO: _____60-120_____/DAYS	
490			
491	5	Carbide Blade 48", 6" top punched, 6 holes, 12" on center holes, 4 footers	90%
492		QUOTING: MFR: __Valk Manufacturing Company__ #	
493		DELIVERY ARO: _____60-120_____/DAYS	
494			
495	6	Carbide Blade 36", 6" top punched, 5 holes, 12" on center holes, 3 footers	90%
496		QUOTING: MFR: __Valk Manufacturing Company__ #	
497		DELIVERY ARO: _____60-120_____/DAYS	
498			
499	7	6" top punched 44" carbide blade, 6 hole	90%
500		QUOTING: MFR: __Valk Manufacturing Company__ #	
501		DELIVERY ARO: _____60-120_____/DAYS	
502			
503	8	6" top punched 44" carbide blade, 5 hole	90%
504		QUOTING: MFR: __Valk Manufacturing Company__ #	
505		DELIVERY ARO: _____60-120_____/DAYS	
506			
507	9	6" top punched 28" carbide blade, 3 hole	90%
508		QUOTING: MFR: __Valk Manufacturing Company__ #	
509		DELIVERY ARO: _____60-120_____/DAYS	
510			
511	10	6" top punched 72" carbide blade, 9 hole	90%
512		QUOTING: MFR: __Valk Manufacturing Company__ #	
513		DELIVERY ARO: _____60-120_____/DAYS	
514			
515		6" top punched 20" carbide blade, 3 hole, right or left	
516			
517	11	Right hand blade	90%
518		QUOTING: MFR: __Valk Manufacturing Company__ #	
519		DELIVERY ARO: _____60-120_____/DAYS	
520			
521	12	Left hand blade	90%
522		QUOTING: MFR: __Valk Manufacturing Company__ #	
523		DELIVERY ARO: _____60-120_____/DAYS	
524			
525	13	6" top punched 48" carbide grader blade, 6 hole	90%
526		QUOTING: MFR: __Valk Manufacturing Company__ #	
527		DELIVERY ARO: _____60-120_____/DAYS	
528			
529	14	6" top punched 36" carbide blade, 5 holes (12")	90%
530		QUOTING: MFR: __Valk Manufacturing Company__ #	
531		DELIVERY ARO: _____60-120_____/DAYS	
532			
533	15	6" top punched 48" carbide blade, 6 holes (12")	90%
534		QUOTING: MFR: __Valk Manufacturing Company__ #	
535		DELIVERY ARO: _____60-120_____/DAYS	
536			
537	16	6" top punched 84" carbide JD grader blade, 15 hole	90%
538		QUOTING: MFR: __Valk Manufacturing Company__ #	

	A	B	C
539		DELIVERY ARO: _____ 60-120 _____ /DAYS	
540			
541	17	8" top punched 60" hardened steel blade, 8 hole	90%
542		QUOTING: MFR: __Valk Manufacturing Company_____ #	
543		DELIVERY ARO: _____ 30-60 _____ DAYS	
544			
545	18	8" top punched 72" hardened steel blade, 9 hole	90%
546		QUOTING: MFR: __Valk Manufacturing Company_____ #	
547		DELIVERY ARO: _____ 30-60 _____ DAYS	
548			
549	19	8" top punched 60" harden steel blade, 7 hole (12")	90%
550		QUOTING: MFR: __Valk Manufacturing Company_____ #	
551		DELIVERY ARO: _____ 30-60 _____ DAYS	
552			
553	20	8" top punched 72" hardened steel blade, 8 hole (12")	90%
554		QUOTING: MFR: __Valk Manufacturing Company_____ #	
555		DELIVERY ARO: _____ 30-60 _____ DAYS	
556			
557	21	8" top punched 84" hardened steel blade, 15 hole	90%
558		QUOTING: MFR: __Valk Manufacturing Company_____ #	
559		DELIVERY ARO: _____ 30-60 _____ DAYS	
560			
561	22	8" center punched 11' regular steel blade, 17 hole	90%
562		QUOTING: MFR: __Valk Manufacturing Company_____ #	
563		DELIVERY ARO: _____ 30-60 _____ DAYS	
564			
565	23	6" top punched 11' regular steel blade, 17 hole	90%
566		QUOTING: MFR: __Valk Manufacturing Company_____ #	
567		DELIVERY ARO: _____ 30-60 _____ DAYS	
568			
569	24	17 hole, 8" TP, 11' plow blade	90%
570		QUOTING: MFR: __Valk Manufacturing Company_____ #	
571		DELIVERY ARO: _____ 30-60 _____ DAYS	
572			
573	25	14 hole, 6" TP, 12' plow blade	90%
574		QUOTING: MFR: __Valk Manufacturing Company_____ #	
575		DELIVERY ARO: _____ 30-60 _____ DAYS	
576			
577	26	6" top punched 11' regular steel blade, 13 hole (12")	90%
578		QUOTING: MFR: __Valk Manufacturing Company_____ #	
579		DELIVERY ARO: _____ 30-60 _____ DAYS	
580			
581	27	6" top punched 10' regular steel blade, 12 holes (12")	90%
582		QUOTING: MFR: __Valk Manufacturing Company_____ #	
583		DELIVERY ARO: _____ 30-60 _____ DAYS	
584			
585	28	6" top punched 9' regular steel blade, 11 holes (12")	90%
586		QUOTING: MFR: __Valk Manufacturing Company_____ #	
587		DELIVERY ARO: _____ 30-60 _____ DAYS	
588			
589	29	Wing blade, 15 hole, 6" TP RSWB-15	90%
590		QUOTING: MFR: __Valk Manufacturing Company_____ #	
591		DELIVERY ARO: _____ 30-60 _____ DAYS	
592			
593	30	8" center punched 9' regular steel blade, 14 hole	90%
594		QUOTING: MFR: __Valk Manufacturing Company_____ #	
595		DELIVERY ARO: _____ 30-60 _____ DAYS	
596			
597	31	6" top punched 9' regular steel blade, 14 hole	90%
598		QUOTING: MFR: __Valk Manufacturing Company_____ #	
599		DELIVERY ARO: _____ 30-60 _____ DAYS	
600			
601	32	8" top punched 9' regular steel blade, 14 hole	90%
602		QUOTING: MFR: __Valk Manufacturing Company_____ #	
603		DELIVERY ARO: _____ 30-60 _____ DAYS	
604			
605	33	15 hole, 6" TP 10' wing blade	90%

	A	B	C
606		QUOTING: MFR: __Valk Manufacturing Company_____ #	
607		DELIVERY ARO: ____30-60__ DAYS	
608			
609	34	72" Grader blade section, 6"	90%
610		QUOTING: MFR: __Valk Manufacturing Company_____ #	
611		DELIVERY ARO: ____30-60__ DAYS	
612			
613	35	72" Grader blade section, 8"	90%
614		QUOTING: MFR: __Valk Manufacturing Company_____ #	
615		DELIVERY ARO: ____30-60__ DAYS	
616			
617	36	72" Serrated grader blade section, 6"	90%
618		QUOTING: MFR: __Valk Manufacturing Company_____ #	
619		DELIVERY ARO: ____30-60__ DAYS	
620			
621	37	8" center punched 12' regular steel blade, 18 hole	90%
622		QUOTING: MFR: __Valk Manufacturing Company_____ #	
623		DELIVERY ARO: ____30-60__ DAYS	
624			
625	38	11' Cat 120 grader wing, 6" TP	90%
626		QUOTING: MFR: __Valk Manufacturing Company_____ #	
627		DELIVERY ARO: ____30-60__ DAYS	
628			
629	39	John Deere 544E bucket cutting edge	90%
630		QUOTING: MFR: __Valk Manufacturing Company_____ #	
631		DELIVERY ARO: ____30-60__ DAYS	
632			
633	40	John Deere 544G & H bucket cutting edge set	90%
634		QUOTING: MFR: __Valk Manufacturing Company_____ #	
635		DELIVERY ARO: ____30-60__ DAYS	
636			
637	41	End section only - each	90%
638		QUOTING: MFR: __Valk Manufacturing Company_____ #	
639		DELIVERY ARO: ____30-60__ DAYS	
640			
641	42	John Deere 310 & 410 bucket cutting edge	90%
642		QUOTING: MFR: __Valk Manufacturing Company_____ #	
643		DELIVERY ARO: ____30-60__ DAYS	
644			
645	43	Craig snow bucket edge	90%
646		QUOTING: MFR: __Valk Manufacturing Company_____ #	
647		DELIVERY ARO: ____30-60__ DAYS	
648			
649	44	7-1/2' Fisher plow blade 6" TP	90%
650		QUOTING: MFR: __Valk Manufacturing Company_____ #	
651		DELIVERY ARO: ____30-60_____/DAYS	
652			
653	45	6" top punch 8' regular steel blade, 8 hole Fisher Plow	90%
654		QUOTING: MFR: __Valk Manufacturing Company_____ #	
655		DELIVERY ARO: ____30-60_____/DAYS	
656			
657	46	120" Viking runway plow section 8" CP	90%
658		QUOTING: MFR: __Valk Manufacturing Company_____ #	
659		DELIVERY ARO: ____30-60__ DAYS	
660			
661		Curb runners & nose piece)	
662			
663	47	BLADE-SLUSH CARB 4'	90%
664		_Valk Manufacturing Company_	
665		DELIVERY ARO: ____60-120_____/DAYS	
666			
667	48	BLADE-SLUSH CARB 3'	90%
668		_Valk Manufacturing Company_	
669		DELIVERY ARO: ____60-120_____/DAYS	
670			
671	49	BLADE-PLOW CARB 3'	90%
672		_Valk Manufacturing Company_	

	A	B	C
673		DELIVERY ARO: 60-120 /DAYS	
674			
675	50	BLADE-PLOW CARB 4'	90%
676		QUOTING: MFR: Valk Manufacturing Company #	
677		DELIVERY ARO: 60-120 /DAYS	
678			
679	51	BLADE-GRADER 6'; Std. Curved; 3-3-12 punch	90%
680		QUOTING: MFR: Valk Manufacturing Company #	
681		DELIVERY ARO: 30-60 /DAYS	
682			
683	52	BLADE-GRADER SAWTOOTH 6'	90%
684		QUOTING: MFR: Valk Manufacturing Company #	
685		DELIVERY ARO: 30-60 DAYS	
686			
687	53	BLADE-WING 10' 3-3-12 104 AP	90%
688		QUOTING: MFR: Valk Manufacturing Company #	
689		DELIVERY ARO: 30-60 DAYS	
690			
691	54	BLADE-WING 11' 3-3-12 102 AP	90%
692		QUOTING: MFR: Valk Manufacturing Company #	
693		DELIVERY ARO: 30-60 DAYS	
694			
695	55	BLADE-WING 13' 3-3-12 115 AP	90%
696		QUOTING: MFR: Valk Manufacturing Company #	
697		DELIVERY ARO: 30-60 DAYS	
698			
699	56	BLADE-BUCKET LG CASE 621/621B #L127366	90%
700		QUOTING: MFR: Valk Manufacturing Company #	
701		DELIVERY ARO: 30-60 DAYS	
702			
703	57	BLADE-BUCKET SM CASE 621/621B #L127367	90%
704		QUOTING: MFR: Valk Manufacturing Company #	
705		DELIVERY ARO: 30-60 DAYS	
706			
707	58	BLADE-WING EVEREST 1/2X6X9' 3-3-12 107AP	90%
708		Valk Manufacturing Company	
709		QUOTING: MFR: Valk Manufacturing Company #	
710		DELIVERY ARO: 30-60 DAYS	
711	59	BLADE-WING 12'JD GRADER 3-3-12 113AP	90%
712		QUOTING: MFR: Valk Manufacturing Company #	
713		DELIVERY ARO: 30-60 DAYS	
714			
715	60	BLADE-BUCKET CASE 580L/SL 10H #112946A1	90%
716		QUOTING: MFR: Valk Manufacturing Company #	
717		DELIVERY ARO: 30-60 DAYS	
718			
719	61	BLADE-BUCKET CASE 580SM #185506A1	90%
720		QUOTING: MFR: Valk Manufacturing Company #	
721		DELIVERY ARO: 30-60 DAYS	
722			
723	62	John Deere Loader 444 Ends T146673	90%
724		QUOTING: MFR: Valk Manufacturing Company #	
725		DELIVERY ARO: 30-60 DAYS	
726			
727	63	John Deere Loader 444 Centers T157311	90%
728		QUOTING: MFR: Valk Manufacturing Company #	
729		DELIVERY ARO: 30-60 DAYS	
730			
731	STATE	CONNECTICUT	
732			
733	1	Top Punch, 11' – 312-02-0045	90%
734		QUOTING: MFR: Valk Manufacturing Company #	
735		DELIVERY ARO: 30-60 /DAYS	
736			
737	2	Top Punch, 11', AASHTO, (f/Viking Bottom Trip Plow) 312-02-0097	90%
738		QUOTING: MFR: Valk Manufacturing Company #	
739		DELIVERY ARO: 30-60 /DAYS	

	A	B	C
740			
741	3	Top Punch, 11', (f/newer front mount wing plow)	90%
742		QUOTING: MFR: ___ Valk Manufacturing Company #	
743		DELIVERY ARO: ___ 30-60 ___ /DAYS	
744			
745	4	Top Punch, 10', (f/mid mount retro fit plow)	90%
746		QUOTING: MFR: ___ Valk Manufacturing Company #	
747		DELIVERY ARO: ___ 30-60 ___ /DAYS	
748			
749	5	Hardened (sets) – 312-02-0050	90%
750		QUOTING: MFR: ___ Valk Manufacturing Company #	
751		DELIVERY ARO: ___ 30-60 ___ /DAYS	
752			
753	6	Blade 8' (Fisher Plow)- 312-02-0065	90%
754		QUOTING: MFR: ___ Valk Manufacturing Company #	
755		DELIVERY ARO: ___ 30-60 ___ /DAYS	
756			
757	7	Grader 6' (saw) – 312-02-0008	90%
758		QUOTING: MFR: ___ Valk Manufacturing	
759		DELIVERY ARO: ___ 30-60 ___ /DAYS	
760			
761	8	Payloader (John Deere 444 & D) – 312-02-0053	90%
762		QUOTING: MFR: ___ Valk Manufacturing Company #	
763		DELIVERY ARO: ___ 30-60 ___ DAYS	
764			
765	9	Payloader (John Deere 544E & G) – 312-02-0073	90%
766		QUOTING: MFR: ___ Valk Manufacturing Company #	
767		DELIVERY ARO: ___ 30-60 ___ DAYS	
768			
769	10	Payloader (John Deere 444H) One piece 312-02-0084	90%
770		QUOTING: MFR: ___ Valk Manufacturing Company #	
771		DELIVERY ARO: ___ 30-60 ___ DAYS	
772			
773	11	Outside piece – (f/02 Volvo & Cat also) 312-02-0091	90%
774		QUOTING: MFR: ___ Valk Manufacturing Company #	
775		DELIVERY ARO: ___ 30-60 ___ DAYS	
776			
777	12	Center piece – JD Bucket Only 312-02-0092	90%
778		QUOTING: MFR: ___ Valk Manufacturing Company #	
779		DELIVERY ARO: ___ 30-60 ___ DAYS	
780			
781	13	Payloader (VME Model L70C – Center Piece, Volvo Bucket) 312-02-0077	90%
782		QUOTING: MFR: ___ Valk Manufacturing Company #	
783		DELIVERY ARO: ___ 30-60 ___ DAYS	
784			
785	14	Payloader (VME Model L70C – End Piece, Volvo Bucket) 312-02-0078	90%
786		QUOTING: MFR: ___ Valk Manufacturing Company #	
787		DELIVERY ARO: ___ 30-60 ___ DAYS	
788			
789	15	Payloader (Multi-piece, f/02 Volvo or Cat loader with JRB Bucket, Center piece) 312-02-0101	90%
790		QUOTING: MFR: ___ Valk Manufacturing Company #	
791		DELIVERY ARO: ___ 30-60 ___ DAYS	
792			
793	16	Backhoe (John Deere 310C) -312-02-0074	90%
794		QUOTING: MFR: ___ Valk Manufacturing Company #	
795		DELIVERY ARO: ___ 30-60 ___ DAYS	
796			
797	17	Backhoe (John Deere 710D) -312-02-0075	90%
798		QUOTING: MFR: ___ Valk Manufacturing Company #	
799		DELIVERY ARO: ___ 30-60 ___ DAYS	
800			
801	18	Backhoe (Volvo BL70) -	90%
802		QUOTING: MFR: ___ Valk Manufacturing Company #	
803		DELIVERY ARO: ___ 30-60 ___ DAYS	
804			
805	19	Bobcat Compact Loader T300	90%
806		QUOTING: MFR: ___ Valk Manufacturing Company #	

	A	B	C
807		DELIVERY ARO: 30-60 DAYS	
808			
809	20	Bobcat Compact Loader T110	90%
810		QUOTING: MFR: Valk Manufacturing Company #	
811		DELIVERY ARO: 30-60 DAYS	
812			Content
813	STATE	UTAH	
814			
815	1	4' Tungsten Carbide Insert Rigid Blade	90%
816		QUOTING: MFR: Valk Manufacturing #	
817		DELIVERY ARO: 90-150 /DAYS	
818			
819	2	4' Articulated Tungsten Carbide Blades	90%
820		QUOTING: MFR: Valk Manufacturing #	
821		DELIVERY ARO: 90-150 /DAYS	
822			
823	3	4' Plain steel cover blades	90%
824		QUOTING: MFR: Valk Manufacturing #	
825		DELIVERY ARO: 90-150 /DAYS	
826			
827			
828			
829	STATE	COLORADO	
830			
831	1	BLADE, BUL NSE, 3/4X8X7",5/8" HOLES,STRT	90%
832		QUOTING: MFR: Valk Manufacturing Company #	
833		DELIVERY ARO: 30-60 /DAYS	
834			
835	2	BLADE, GRADER CURVE 1"x 8" x 7'	90%
836		QUOTING: MFR: Valk Manufacturing Company #	
837		DELIVERY ARO: 30-60 /DAYS	
838			
839	3	BLADE, GRADER CURVE 3/4"x8"x7'	90%
840		QUOTING: MFR: Valk Manufacturing Company #	
841		DELIVERY ARO: 30-60 /DAYS	
842			
843	4	BLADE, GRADER CURVE 5/8"x8"x6'	90%
844		QUOTING: MFR: Valk Manufacturing Company #	
845		DELIVERY ARO: 30-60 /DAYS	
846			
847	5	BLADE, GRADER CURVED, 3/4"x7' 3/4" HOLE	90%
848		QUOTING: MFR: Valk Manufacturing Company #	
849		DELIVERY ARO: 30-60 /DAYS	
850			
851	6	BLADE, GRDR CRVD 5/8"x8"x7',5/8"BLT HOLE	90%
852		QUOTING: MFR: Valk Manufacturing Company #	
853		DELIVERY ARO: 30-60 /DAYS	
854			
855	7	BLADE, GRDR-LDR FLAT 3/4"x 8"x 6' 4T3007	90%
856		QUOTING: MFR: Valk Manufacturing Company #	
857		DELIVERY ARO: 30-60 /DAYS	
858			
859	8	BLADE, PLOW,JD410G,3/4X8X92-3/8",#T84194	90%
860		QUOTING: MFR: Valk Manufacturing Company #	
861		DELIVERY ARO: 30-60 /DAYS	
862			
863			
864	9	BLADE, SNOWPLOW CARB 3/4"x6"x3'	90%
865		QUOTING: MFR: Valk Manufacturing Company #	
866		DELIVERY ARO: 90-150 /DAYS	
867			
868	10	BLADE, SNOWPLOW CARB 3/4"x6"x4'	90%
869		QUOTING: MFR: Valk Manufacturing Company #	
870		DELIVERY ARO: 90-150 /DAYS	
871			

	A	B	C
872	11	BLADE, SNOWPLOW CARB 3/4"X6"X5'	90%
873		QUOTING: MFR: <u> </u> Valk Manufacturing Company #	
874		DELIVERY ARO: <u> </u> 90-150 <u> </u> /DAYS	
875			
876	12	BLADE, SNOWPLOW CARB 3/4"X6"X6'	90%
877		QUOTING: MFR: <u> </u> Valk Manufacturing Company #	
878		DELIVERY ARO: <u> </u> 90-150 <u> </u> /DAYS	
879			
880	13	BLADE, SNOWPLOW HEAT TREAT 3/4"X6"X4'	90%
881		QUOTING: MFR: <u> </u> Valk Manufacturing Company #	
882		DELIVERY ARO: <u> </u> 30-60 <u> </u> /DAYS	
883			
884	14	BLADE, SNOWPLOW HEAT TREAT 3/4"X6"X5'	90%
885		QUOTING: MFR: <u> </u> Valk Manufacturing Company #	
886		DELIVERY ARO: <u> </u> 30-60 <u> </u> /DAYS	
887			
888	15	BLADE, SNOWPLOW HEAT TREAT 3/4"X6"X6'	90%
889		QUOTING: MFR: <u> </u> Valk Manufacturing Company #	
890		DELIVERY ARO: <u> </u> 30-60 <u> </u> /DAYS	
891			
892	16	BLADE, SNOWPLOW HEAT TREAT 3/4"X6"X9'	90%
893		QUOTING: MFR: <u> </u> Valk Manufacturing Company #	
894		DELIVERY ARO: <u> </u> 30-60 <u> </u> /DAYS	
895			
896	17	BLADE, SNOWPLOW HEAT TREAT 3/4"X8"X6'	90%
897		QUOTING: MFR: <u> </u> Valk Manufacturing Company #	
898		DELIVERY ARO: <u> </u> 30-60 <u> </u> /DAYS	
899			
900	18	BLADE, SNOWPLOW HEAT TREAT 3/4"X8"X9'	90%
901		QUOTING: MFR: <u> </u> Valk Manufacturing Company #	
902		DELIVERY ARO: <u> </u> 30-60 <u> </u> /DAYS	
903			
904	19	BLADE, V SNOWPLOW, BOSS 10' COMPLETE,TXT	90%
905		QUOTING: MFR: <u> </u> Valk Manufacturing Company #	
906		DELIVERY ARO: <u> </u> 30-60 <u> </u> /DAYS	
907			Post Consum
908			Content
909	STATE	IDAHO	
910			
911	1	Tungsten Carbid Tipped edge - 5" x 3/4" x 4" Long	90%
912		QUOTING: MFR: <u> </u> Valk Manufacturing Company #	
913		DELIVERY ARO: <u> </u> 60-120 <u> </u> /DAYS	
914			
915	2	Tungsten Carbid Tipped edge - 5" x 3/4" x 3" Long	90%
916		QUOTING: MFR: <u> </u> Valk Manufacturing Company #	
917		DELIVERY ARO: <u> </u> 60-120 <u> </u> /DAYS	
918			
919	3	Tungsten Carbid Tipped edge - 6" x 3/4" x 4" Long	90%
920		QUOTING: MFR: <u> </u> Valk Manufacturing Company #	
921		DELIVERY ARO: <u> </u> 60-120 <u> </u> /DAYS	
922			
923	4	Tungsten Carbid Tipped edge - 6" x 3/4" x 3" Long	90%
924		QUOTING: MFR: <u> </u> Valk Manufacturing Company #	
925		DELIVERY ARO: <u> </u> 60-120 <u> </u> /DAYS	
926			
927			
928	STATE	NEW YORK	Post Consum
929		DESCRIPTION	Content
930		BLADES	
931			
932	1	TYPE OF STEEL SAE 1080 (AISI - 1080)	90%
933		Grader Blade 3/4" x 8" x 72"	
934		QUOTING: MFR: <u> </u> Valk Manufacturing Company #	
935		DELIVERY ARO: <u> </u> 30-60 <u> </u> /DAYS	
936			
937	2	Snow Plow 1/2" x 8" x 132"	

	A	B	C
938		QUOTING: MFR: <u> Valk Manufacturing Company </u> #	
939		DELIVERY ARO: <u> 30-60 </u> /DAYS	
940			
941	3	Snow Plow 1/2" x 8" x 132"	90%
942		QUOTING: MFR: <u> Valk Manufacturing Company </u> #	
943		DELIVERY ARO: <u> 30-60 </u> /DAYS	
944			
945	4	Tractor Shovel 7/8" x 10" x 100"	90%
946		QUOTING: MFR: <u> Valk Manufacturing Company </u> #	
947		DELIVERY ARO: <u> 30-60 </u> /DAYS	
948			
949	5	TYPE OF STEEL SAE 1020 (AISI - 1020)	90%
950		Snow Plow 3/4" x 6" x 36" with tungsten carbide inserts	
951		QUOTING: MFR: <u> Valk Manufacturing Company </u> #	
952		DELIVERY ARO: <u> 60-120 </u> /DAYS	
953			
954	6	Snow Plow 3/4" x 6" x 48" with tungsten carbide inserts	90%
955		QUOTING: MFR: <u> Valk Manufacturing Company </u> #	
956		DELIVERY ARO: <u> 60-120 </u> /DAYS	
957			
958	7	Fabricated Plow Shoe	90%
959		QUOTING: MFR: <u> Valk Manufacturing Company </u> #	
960		DELIVERY ARO: <u> 60-120 </u> /DAYS	
961			
962	8	SECTION CENTER - CARBIDE INSERT BLADE	90%
963		3/4 X 6 X 28 IN.	
964		QUOTING: MFR: <u> Valk Manufacturing Company </u> #	
965		DELIVERY ARO: <u> 60-120 </u> /DAYS	
966			
967	9	SECTION END CARBIDE	90%
968		INSERT BLADE 3/4 X 6 X 44	
969		QUOTING: MFR: <u> Valk Manufacturing Company </u> #	
970		DELIVERY ARO: <u> 60-120 </u> /DAYS	
971			
972	10	SECTION 5-HOLE CARBIDE INSERT WING	90%
973		BLADE 3/4 X 6 X 42	
974		QUOTING: MFR: <u> Valk Manufacturing Company </u> #	
975		DELIVERY ARO: <u> 60-120 </u> /DAYS	
976			
977	11	SECTION END 5-HOLE CARBIDE INSERT WING	90%
978		BLADE 3/4 X 6 X 40 IN	
979		QUOTING: MFR: <u> Valk Manufacturing Company </u> #	
980		DELIVERY ARO: <u> 60-120 </u> /DAYS	
981			
982	12	SECTION 6-HOLE CARBIDE INSERT WING	90%
983		BLADE 3/4 X 6 X 46 IN	
984		QUOTING: MFR: <u> Valk Manufacturing Company </u> #	
985		DELIVERY ARO: <u> 60-120 </u> /DAYS	
986			
987	13	SECTION CENTER CARB	90%
988		INSERT BLADE 3/4 X 6 X 44	
989		QUOTING: MFR: <u> Valk Manufacturing Company </u> #	
990		DELIVERY ARO: <u> 60-120 </u> /DAYS	
991			
992	14	SECTION END CARBIDE	90%
993		INSERT BLADE 3/4 X 6 X 38 IN.5-HOLE	
994		QUOTING: MFR: <u> Valk Manufacturing Company </u> #	
995		DELIVERY ARO: <u> 60-120 </u> /DAYS	
996			
997	15	SECTION END CARBIDE	90%
998		INSERT BLADE 3/4 X 6 X 38 IN.5-HOLE	
999		QUOTING: MFR: <u> Valk Manufacturing Company </u> #	
1000		DELIVERY ARO: <u> 60-120 </u> /DAYS	
1001			
1002	16	EDGE WING 12 FT 212112	90%
1003		QUOTING: MFR: <u> Valk Manufacturing Company </u> #	
1004		DELIVERY ARO: <u> 60-120 </u> /DAYS	

	A	B	C
1005			
1006			
1007			
1008		Any	
1009	State:	OTHER BLADES OR BLADE SYSTEMS	
1010			
1011	1	6' Plain steel cover blades	90%
1012		QUOTING: MFR: _____ Valk Manufacturing _____ # _____	
1013		DELIVERY ARO: _____ 30-60 _____ /DAYS	
1014			
1015			
1016			

**ATTACHMENT C: STANDARD STATE PROVISIONS
FOR CONTRACTS AND GRANTS
REVISED DECEMBER 15, 2017**

1. Definitions: For purposes of this Attachment, “Party” shall mean the Contractor, Grantee or Subrecipient, with whom the State of Vermont is executing this Agreement and consistent with the form of the Agreement. “Agreement” shall mean the specific contract or grant to which this form is attached.

2. Entire Agreement: This Agreement, whether in the form of a contract, State-funded grant, or Federally-funded grant, represents the entire agreement between the parties on the subject matter. All prior agreements, representations, statements, negotiations, and understandings shall have no effect.

3. Governing Law, Jurisdiction and Venue; No Waiver of Jury Trial: This Agreement will be governed by the laws of the State of Vermont. Any action or proceeding brought by either the State or the Party in connection with this Agreement shall be brought and enforced in the Superior Court of the State of Vermont, Civil Division, Washington Unit. The Party irrevocably submits to the jurisdiction of this court for any action or proceeding regarding this Agreement. The Party agrees that it must first exhaust any applicable administrative remedies with respect to any cause of action that it may have against the State with regard to its performance under this Agreement. Party agrees that the State shall not be required to submit to binding arbitration or waive its right to a jury trial.

4. Sovereign Immunity: The State reserves all immunities, defenses, rights or actions arising out of the State’s sovereign status or under the Eleventh Amendment to the United States Constitution. No waiver of the State’s immunities, defenses, rights or actions shall be implied or otherwise deemed to exist by reason of the State’s entry into this Agreement.

5. No Employee Benefits For Party: The Party understands that the State will not provide any individual retirement benefits, group life insurance, group health and dental insurance, vacation or sick leave, workers compensation or other benefits or services available to State employees, nor will the State withhold any state or Federal taxes except as required under applicable tax laws, which shall be determined in advance of execution of the Agreement. The Party understands that all tax returns required by the Internal Revenue Code and the State of Vermont, including but not limited to income, withholding, sales and use, and rooms and meals, must be filed by the Party, and information as to Agreement income will be provided by the State of Vermont to the Internal Revenue Service and the Vermont Department of Taxes.

6. Independence: The Party will act in an independent capacity and not as officers or employees of the State.

7. Defense and Indemnity: The Party shall defend the State and its officers and employees against all third party claims or suits arising in whole or in part from any act or omission of the Party or of any agent of the Party in connection with the performance of this Agreement. The State shall notify the Party in the event of any such claim or suit, and the Party shall immediately retain counsel and otherwise provide a complete defense against the entire claim or suit. The State retains the right to participate at its own expense in the defense of any claim. The State shall have the right to approve all proposed settlements of such claims or suits.

After a final judgment or settlement, the Party may request recoupment of specific defense costs and may file suit in Washington Superior Court requesting recoupment. The Party shall be entitled to recoup costs only upon a showing that such costs were entirely unrelated to the defense of any claim arising from an act or omission of the Party in connection with the performance of this Agreement.

The Party shall indemnify the State and its officers and employees if the State, its officers or employees become legally obligated to pay any damages or losses arising from any act or omission of the Party or an agent of the Party in connection with the performance of this Agreement.

Notwithstanding any contrary language anywhere, in no event shall the terms of this Agreement or any document furnished by the Party in connection with its performance under this Agreement obligate the State to (1) defend or indemnify the Party or any third party, or (2) otherwise be liable for the expenses or reimbursement, including attorneys’ fees, collection costs or other costs of the Party or any third party.

8. Insurance: Before commencing work on this Agreement the Party must provide certificates of insurance to show that the following minimum coverages are in effect. It is the responsibility of the Party to maintain current certificates of insurance on file with the State through the term of this Agreement. No warranty is made that the coverages and limits listed

herein are adequate to cover and protect the interests of the Party for the Party's operations. These are solely minimums that have been established to protect the interests of the State.

Workers Compensation: With respect to all operations performed, the Party shall carry workers' compensation insurance in accordance with the laws of the State of Vermont. Vermont will accept an out-of-state employer's workers' compensation coverage while operating in Vermont provided that the insurance carrier is licensed to write insurance in Vermont and an amendatory endorsement is added to the policy adding Vermont for coverage purposes. Otherwise, the party shall secure a Vermont workers' compensation policy, if necessary to comply with Vermont law.

General Liability and Property Damage: With respect to all operations performed under this Agreement, the Party shall carry general liability insurance having all major divisions of coverage including, but not limited to:

Premises - Operations

Products and Completed Operations

Personal Injury Liability

Contractual Liability

The policy shall be on an occurrence form and limits shall not be less than:

\$1,000,000 Each Occurrence

\$2,000,000 General Aggregate

\$1,000,000 Products/Completed Operations Aggregate

\$1,000,000 Personal & Advertising Injury

Automotive Liability: The Party shall carry automotive liability insurance covering all motor vehicles, including hired and non-owned coverage, used in connection with the Agreement. Limits of coverage shall not be less than \$500,000 combined single limit. If performance of this Agreement involves construction, or the transport of persons or hazardous materials, limits of coverage shall not be less than \$1,000,000 combined single limit.

Additional Insured. The General Liability and Property Damage coverages required for performance of this Agreement shall include the State of Vermont and its agencies, departments, officers and employees as Additional Insureds. If performance of this Agreement involves construction, or the transport of persons or hazardous materials, then the required Automotive Liability coverage shall include the State of Vermont and its agencies, departments, officers and employees as Additional Insureds. Coverage shall be primary and non-contributory with any other insurance and self-insurance.

Notice of Cancellation or Change. There shall be no cancellation, change, potential exhaustion of aggregate limits or non-renewal of insurance coverage(s) without thirty (30) days written prior written notice to the State.

9. Reliance by the State on Representations: All payments by the State under this Agreement will be made in reliance upon the accuracy of all representations made by the Party in accordance with this Agreement, including but not limited to bills, invoices, progress reports and other proofs of work.

10. False Claims Act: The Party acknowledges that it is subject to the Vermont False Claims Act as set forth in 32 V.S.A. § 630 *et seq.* If the Party violates the Vermont False Claims Act it shall be liable to the State for civil penalties, treble damages and the costs of the investigation and prosecution of such violation, including attorney's fees, except as the same may be reduced by a court of competent jurisdiction. The Party's liability to the State under the False Claims Act shall not be limited notwithstanding any agreement of the State to otherwise limit Party's liability.

11. Whistleblower Protections: The Party shall not discriminate or retaliate against one of its employees or agents for disclosing information concerning a violation of law, fraud, waste, abuse of authority or acts threatening health or safety, including but not limited to allegations concerning the False Claims Act. Further, the Party shall not require such employees or agents to forego monetary awards as a result of such disclosures, nor should they be required to report misconduct to the Party or its agents prior to reporting to any governmental entity and/or the public.

12. Location of State Data: No State data received, obtained, or generated by the Party in connection with performance under this Agreement shall be processed, transmitted, stored, or transferred by any means outside the continental United States, except with the express written permission of the State.

13. Records Available for Audit: The Party shall maintain all records pertaining to performance under this agreement. "Records" means any written or recorded information, regardless of physical form or characteristics, which is produced or

acquired by the Party in the performance of this agreement. Records produced or acquired in a machine readable electronic format shall be maintained in that format. The records described shall be made available at reasonable times during the period of the Agreement and for three years thereafter or for any period required by law for inspection by any authorized representatives of the State or Federal Government. If any litigation, claim, or audit is started before the expiration of the three-year period, the records shall be retained until all litigation, claims or audit findings involving the records have been resolved.

14. Fair Employment Practices and Americans with Disabilities Act: Party agrees to comply with the requirement of 21 V.S.A. Chapter 5, Subchapter 6, relating to fair employment practices, to the full extent applicable. Party shall also ensure, to the full extent required by the Americans with Disabilities Act of 1990, as amended, that qualified individuals with disabilities receive equitable access to the services, programs, and activities provided by the Party under this Agreement.

15. Set Off: The State may set off any sums which the Party owes the State against any sums due the Party under this Agreement; provided, however, that any set off of amounts due the State of Vermont as taxes shall be in accordance with the procedures more specifically provided hereinafter.

16. Taxes Due to the State:

- A. Party understands and acknowledges responsibility, if applicable, for compliance with State tax laws, including income tax withholding for employees performing services within the State, payment of use tax on property used within the State, corporate and/or personal income tax on income earned within the State.
- B. Party certifies under the pains and penalties of perjury that, as of the date this Agreement is signed, the Party is in good standing with respect to, or in full compliance with, a plan to pay any and all taxes due the State of Vermont.
- C. Party understands that final payment under this Agreement may be withheld if the Commissioner of Taxes determines that the Party is not in good standing with respect to or in full compliance with a plan to pay any and all taxes due to the State of Vermont.
- D. Party also understands the State may set off taxes (and related penalties, interest and fees) due to the State of Vermont, but only if the Party has failed to make an appeal within the time allowed by law, or an appeal has been taken and finally determined and the Party has no further legal recourse to contest the amounts due.

17. Taxation of Purchases: All State purchases must be invoiced tax free. An exemption certificate will be furnished upon request with respect to otherwise taxable items.

18. Child Support: (Only applicable if the Party is a natural person, not a corporation or partnership.) Party states that, as of the date this Agreement is signed, he/she:

- A. is not under any obligation to pay child support; or
- B. is under such an obligation and is in good standing with respect to that obligation; or
- C. has agreed to a payment plan with the Vermont Office of Child Support Services and is in full compliance with that plan.

Party makes this statement with regard to support owed to any and all children residing in Vermont. In addition, if the Party is a resident of Vermont, Party makes this statement with regard to support owed to any and all children residing in any other state or territory of the United States.

19. Sub-Agreements: Party shall not assign, subcontract or subgrant the performance of this Agreement or any portion thereof to any other Party without the prior written approval of the State. Party shall be responsible and liable to the State for all acts or omissions of subcontractors and any other person performing work under this Agreement pursuant to an agreement with Party or any subcontractor.

In the case this Agreement is a contract with a total cost in excess of \$250,000, the Party shall provide to the State a list of all proposed subcontractors and subcontractors' subcontractors, together with the identity of those subcontractors' workers compensation insurance providers, and additional required or requested information, as applicable, in accordance with Section 32 of The Vermont Recovery and Reinvestment Act of 2009 (Act No. 54).

Party shall include the following provisions of this Attachment C in all subcontracts for work performed solely for the State of Vermont and subcontracts for work performed in the State of Vermont: Section 10 ("False Claims Act"); Section 11 ("Whistleblower Protections"); Section 12 ("Location of State Data"); Section 14 ("Fair Employment Practices and

Americans with Disabilities Act”); Section 16 (“Taxes Due the State”); Section 18 (“Child Support”); Section 20 (“No Gifts or Gratuities”); Section 22 (“Certification Regarding Debarment”); Section 30 (“State Facilities”); and Section 32.A (“Certification Regarding Use of State Funds”).

20. No Gifts or Gratuities: Party shall not give title or possession of anything of substantial value (including property, currency, travel and/or education programs) to any officer or employee of the State during the term of this Agreement.

21. Copies: Party shall use reasonable best efforts to ensure that all written reports prepared under this Agreement are printed using both sides of the paper.

22. Certification Regarding Debarment: Party certifies under pains and penalties of perjury that, as of the date that this Agreement is signed, neither Party nor Party’s principals (officers, directors, owners, or partners) are presently debarred, suspended, proposed for debarment, declared ineligible or excluded from participation in Federal programs, or programs supported in whole or in part by Federal funds.

Party further certifies under pains and penalties of perjury that, as of the date that this Agreement is signed, Party is not presently debarred, suspended, nor named on the State’s debarment list at: <http://bgs.vermont.gov/purchasing/debarment>

23. Conflict of Interest: Party shall fully disclose, in writing, any conflicts of interest or potential conflicts of interest.

24. Confidentiality: Party acknowledges and agrees that this Agreement and any and all information obtained by the State from the Party in connection with this Agreement are subject to the State of Vermont Access to Public Records Act, 1 V.S.A. § 315 et seq.

25. Force Majeure: Neither the State nor the Party shall be liable to the other for any failure or delay of performance of any obligations under this Agreement to the extent such failure or delay shall have been wholly or principally caused by acts or events beyond its reasonable control rendering performance illegal or impossible (excluding strikes or lock-outs) (“Force Majeure”). Where Force Majeure is asserted, the nonperforming party must prove that it made all reasonable efforts to remove, eliminate or minimize such cause of delay or damages, diligently pursued performance of its obligations under this Agreement, substantially fulfilled all non-excused obligations, and timely notified the other party of the likelihood or actual occurrence of an event described in this paragraph.

26. Marketing: Party shall not refer to the State in any publicity materials, information pamphlets, press releases, research reports, advertising, sales promotions, trade shows, or marketing materials or similar communications to third parties except with the prior written consent of the State.

27. Termination:

A. Non-Appropriation: If this Agreement extends into more than one fiscal year of the State (July 1 to June 30), and if appropriations are insufficient to support this Agreement, the State may cancel at the end of the fiscal year, or otherwise upon the expiration of existing appropriation authority. In the case that this Agreement is a Grant that is funded in whole or in part by Federal funds, and in the event Federal funds become unavailable or reduced, the State may suspend or cancel this Grant immediately, and the State shall have no obligation to pay Subrecipient from State revenues.

B. Termination for Cause: Either party may terminate this Agreement if a party materially breaches its obligations under this Agreement, and such breach is not cured within thirty (30) days after delivery of the non-breaching party’s notice or such longer time as the non-breaching party may specify in the notice.

C. Termination Assistance: Upon nearing the end of the final term or termination of this Agreement, without respect to cause, the Party shall take all reasonable and prudent measures to facilitate any transition required by the State. All State property, tangible and intangible, shall be returned to the State upon demand at no additional cost to the State in a format acceptable to the State.

28. Continuity of Performance: In the event of a dispute between the Party and the State, each party will continue to perform its obligations under this Agreement during the resolution of the dispute until this Agreement is terminated in accordance with its terms.

29. No Implied Waiver of Remedies: Either party's delay or failure to exercise any right, power or remedy under this Agreement shall not impair any such right, power or remedy, or be construed as a waiver of any such right, power or remedy. All waivers must be in writing.

30. State Facilities: If the State makes space available to the Party in any State facility during the term of this Agreement for purposes of the Party's performance under this Agreement, the Party shall only use the space in accordance with all policies and procedures governing access to and use of State facilities which shall be made available upon request. State facilities will be made available to Party on an "AS IS, WHERE IS" basis, with no warranties whatsoever.

31. Requirements Pertaining Only to Federal Grants and Subrecipient Agreements: If this Agreement is a grant that is funded in whole or in part by Federal funds:

- A. Requirement to Have a Single Audit:** The Subrecipient will complete the Subrecipient Annual Report annually within 45 days after its fiscal year end, informing the State of Vermont whether or not a Single Audit is required for the prior fiscal year. If a Single Audit is required, the Subrecipient will submit a copy of the audit report to the granting Party within 9 months. If a single audit is not required, only the Subrecipient Annual Report is required. For fiscal years ending before December 25, 2015, a Single Audit is required if the subrecipient expends \$500,000 or more in Federal assistance during its fiscal year and must be conducted in accordance with OMB Circular A-133. For fiscal years ending on or after December 25, 2015, a Single Audit is required if the subrecipient expends \$750,000 or more in Federal assistance during its fiscal year and must be conducted in accordance with 2 CFR Chapter I, Chapter II, Part 200, Subpart F. The Subrecipient Annual Report is required to be submitted within 45 days, whether or not a Single Audit is required.
- B. Internal Controls:** In accordance with 2 CFR Part II, §200.303, the Party must establish and maintain effective internal control over the Federal award to provide reasonable assurance that the Party is managing the Federal award in compliance with Federal statutes, regulations, and the terms and conditions of the award. These internal controls should be in compliance with guidance in "Standards for Internal Control in the Federal Government" issued by the Comptroller General of the United States and the "Internal Control Integrated Framework", issued by the Committee of Sponsoring Organizations of the Treadway Commission (COSO).
- C. Mandatory Disclosures:** In accordance with 2 CFR Part II, §200.113, Party must disclose, in a timely manner, in writing to the State, all violations of Federal criminal law involving fraud, bribery, or gratuity violations potentially affecting the Federal award. Failure to make required disclosures may result in the imposition of sanctions which may include disallowance of costs incurred, withholding of payments, termination of the Agreement, suspension/debarment, etc.

32. Requirements Pertaining Only to State-Funded Grants:

- A. Certification Regarding Use of State Funds:** If Party is an employer and this Agreement is a State-funded grant in excess of \$1,001, Party certifies that none of these State funds will be used to interfere with or restrain the exercise of Party's employee's rights with respect to unionization.
- B. Good Standing Certification (Act 154 of 2016):** If this Agreement is a State-funded grant, Party hereby represents: (i) that it has signed and provided to the State the form prescribed by the Secretary of Administration for purposes of certifying that it is in good standing (as provided in Section 13(a)(2) of Act 154) with the Agency of Natural Resources and the Agency of Agriculture, Food and Markets, or otherwise explaining the circumstances surrounding the inability to so certify, and (ii) that it will comply with the requirements stated therein.

(End of Standard Provisions)

State of Vermont

Buildings and General Services
Office of Purchasing & Contracting
109 State St
Montpelier VT 05609-3001
USA

CONTRACT



Vendor ID 0000010383
Valk Manufacturing Co
PO Box 428
New Kingstown PA 17072-0428
USA

Contract ID 000000000000000000029018	Page 1 of 4	
Contract Dates 06/30/2015 to 06/30/2018	Origin CPS	
Description: SNOWPLOW BLADE CUTTING EDGES	Contract Maximum \$9,999,990.00	
Buyer Name Smith, Steven D	Buyer Phone 828-4681	Contract Status Approved

Phone #: 717-766-0711

Line #	Item ID	Item Desc	UOM	Unit Price	Max Qty	Max Amt
1		SNOWPLOW BLADE CUTTING EDGES	EA	0.01000	0.00	0.00

BLADES AND PRICES PER THE ATTACHED LIST

STANDARD CONTRACT FOR SNOWPLOWBLADE CUTTING EDGES

1. Parties. This is a contract for services between the State of Vermont, Office of Purchasing and Contracting (hereafter called "State"), and Valk Manufacturing, with the principal place of business in New Kingstown, PA 07072, (hereafter called "Contractor"). Contractor's form of business organization is Corporation. It is the contractor's responsibility to contact the Vermont Department of Taxes to determine if, by law, the contractor is required to have a Vermont Department of Taxes Business Account Number.

2. Subject Matter. The subject matter of this contract is services generally on the subject of Snowplow Blade Cutting Edges.

3. Contract Term. The period of contractor's performance shall begin on June 30, 2015 and end on June 30, 2017, with option to renew for five (5) one year periods.

If the state exercises the option, it will provide written notice to contractor prior to the end of the term. If exercised, the provision of the option letter shall become part of and be incorporated into the original master price agreement. The total duration of this master price agreement, including the exercise of any options, shall not exceed five years.

4. Prior Approvals. If approval by the Attorney General's Office or the Secretary of Administration is required, (under current law, bulletins, and interpretations), neither this contract nor any amendment to it is binding until it has been approved by either or both such persons.

- Approval by the Attorney General's Office is required.
- Approval by the Secretary of Administration is required.
- Approval by the CIO/Commissioner DII is not required.

5. Amendment. This agreement represents the entire agreement between the parties; No changes, modifications, or amendments in the terms and conditions of this contract shall be effective unless reduced to writing, numbered and signed by the duly authorized representative of the State and Contractor.

6. Cancellation. This contract may be canceled by either party by giving written notice at least thirty (30) days in advance.

7. Attachments. This contract consists of 160 pages including the following attachments which are incorporated herein:

- Attachment A - Master Agreement Terms and Conditions
- Attachment B - Payment Provisions
- Attachment B1-Price Schedule
- Attachment C - "Standard State Provisions for Contracts and Grants" a preprinted form (revision date March 1, 2015).
- Attachment D - Snowplow Blade Cutting Edges Detailed Specifications

8. Order of Precedence. Any ambiguity, conflict or inconsistency in the Contract Documents shall be resolved according to the following order of precedence:

- (1) Standard Contract
- (2) Attachment C (Standard Contract Provisions for Contracts and Grants)
- (3) Attachment A
- (4) Attachment D
- (5) Attachment B
- (6) Attachment B1

CONTRACT

State of Vermont

Buildings and General Services
Office of Purchasing & Contracting
109 State St
Montpelier VT 05609-3001
USA



Vendor ID 0000010383
Valk Manufacturing Co
PO Box 428
New Kingstown PA 17072-0428
USA

Contract ID 0000000000000000000029018	Page 2 of 4
Contract Dates 06/30/2015 to 06/30/2018	Origin CPS
Description: SNOWPLOW BLADE CUTTING EDGES	Contract Maximum \$9,999,990.00
Buyer Name Smith, Steven D	Buyer Phone 828-4681
Contract Status Approved	

Phone #: 717-766-0711

Line #	Item ID	Item Desc	UOM	Unit Price	Max Qty	Max Amt
--------	---------	-----------	-----	------------	---------	---------

CONTRACTOR POC:
Dan Cribari
Sales Manager, Snow Plow Division
Valk Manufacturing Company
plowsales@valkmfg.com
Phone: (717) 766-0711 ext. 122
Fax: (717) 697-6297

STATE OF VERMONT CONTACT:
STEVE SMITH
PURCHASING AGENT
802-828-4681
FAX 802-828-2222
steven.smith@Vermont.gov

QUANTITY: THE ANNUAL VALUE AND QUANTITIES ARE ESTIMATED ONLY BASED ON PRIOR USAGE; ACTUAL PURCHASES MAY BE HIGHER OR LOWER DEPENDING ON THE STATE'S NEEDS. THE CONTRACT MAXIMUM IS NOT REFLECTIVE OF ACTUAL USAGE.

DELIVERY: RESPONSIBILITY FOR PRODUCT DELIVERY REMAINS WITH THE CONTRACTOR UNTIL THE PRODUCT IS PROPERLY DELIVERED AND SIGNED FOR IN ACCORDANCE WITH THE OFFICE OF PURCHASING & CONTRACTING TERMS AND CONDITIONS. SHIPMENTS SHALL BE SECURELY AND PROPERLY PACKED, ACCORDING TO ACCEPTED COMMERCIAL PRACTICES, WITHOUT EXTRA CHARGE FOR PACKING CASES OR OTHER CONTAINERS. SUCH CONTAINERS WILL REMAIN THE PROPERTY OF THE STATE UNLESS OTHERWISE STATED. DELIVERED GOODS THAT DO NOT CONFORM TO THE SPECIFICATIONS OR ARE NOT IN GOOD CONDITION UPON RECEIPT SHALL BE REPLACED PROMPTLY BY THE CONTRACTOR.

PRICING: ALL EQUIPMENT PRICING IS TO INCLUDE F.O.B. DELIVERY TO THE ORDERING FACILITY. NO REQUEST FOR EXTRA DELIVERY COST WILL BE HONORED. ALL EQUIPMENT SHALL BE DELIVERED ASSEMBLED, SERVICED, OILED, AND READY FOR IMMEDIATE USE, UNLESS OTHERWISE REQUESTED BY THE PURCHASING AGENCY.

QUALITY: ALL PRODUCTS PROVIDED UNDER THESE AGREEMENTS WILL BE NEW AND UNUSED, UNLESS OTHERWISE STATED. FACTORY SECONDS OR REMANUFACTURED PRODUCTS WILL NOT BE ACCEPTED UNLESS SPECIFICALLY REQUESTED BY THE PURCHASING AGENCY. ALL PRODUCTS PROVIDED BY THE CONTRACTOR MUST MEET ALL FEDERAL, STATE, AND LOCAL STANDARDS FOR QUALITY AND SAFETY REQUIREMENTS. PRODUCTS NOT MEETING THESE STANDARDS WILL BE DEEMED UNACCEPTABLE AND RETURNED TO THE CONTRACTOR FOR CREDIT AT NO CHARGE TO THE STATE.

METHOD OF ORDERING: PURCHASE ORDERS MUST BE USED TO ORDER ITEMS AVAILABLE UNDER THIS CONTRACT. IF VERBAL ORDERS ARE GIVEN A CONFIRMING PURCHASE ORDER MUST BE ISSUED.

INVOICING: ALL INVOICES ARE TO BE RENDERED BY THE CONTRACTOR ON THE VENDOR'S STANDARD BILLHEAD AND FORWARDED DIRECTLY TO THE INSTITUTION OR AGENCY ORDERING MATERIALS OR SERVICES AND SHALL SPECIFY THE ADDRESS TO WHICH PAYMENTS WILL BE SENT.

CANCELLATION: THE STATE SPECIFICALLY RESERVES THE RIGHT TO CANCEL THE CONTRACT, OR ANY PORTION THEREOF, IF, IN THE OPINION OF ITS COMMISSIONER OF BUILDINGS AND GENERAL SERVICES, THE SERVICES OR MATERIALS SUPPLIED BY THE CONTRACTOR ARE NOT SATISFACTORY OR ARE NOT CONSISTENT WITH THE TERMS OF THE CONTRACT

DEFAULT: IN CASE OF DEFAULT OF THE CONTRACTOR, THE STATE MAY PROCURE THE MATERIALS OR SUPPLIES FROM OTHER SOURCES AND HOLD THE CONTRACTOR RESPONSIBLE FOR ANY EXCESS COST OCCASIONED THEREBY, PROVIDED, THAT IF PUBLIC NECESSITY REQUIRES THE USE OF MATERIALS OR SUPPLIES NOT CONFORMING TO THE SPECIFICATIONS THEY MAY BE ACCEPTED AND PAYMENT THEREFORE SHALL BE MADE AT A PROPER REDUCTION IN PRICE.

CONTRACT TERMS: THIS CONTRACT WILL BE SUBJECT TO REVIEW THROUGHOUT ITS TERM. THE STATE WILL CONSIDER CANCELLATION UPON DISCOVERY THAT A VENDOR IS IN VIOLATION OF ANY PORTION OF THE AGREEMENT, INCLUDING AN INABILITY BY THE VENDOR TO PROVIDE THE PRODUCTS, SUPPORT, AND/OR SERVICE OFFERED IN THEIR RESPONSE.

CONTRACT TERMS AND ADDITIONAL INFORMATION

CONTRACT

State of Vermont

Buildings and General Services
Office of Purchasing & Contracting
109 State St
Montpelier VT 05609-3001
USA



Vendor ID 0000010383
Valk Manufacturing Co
PO Box 428
New Kingstown PA 17072-0428
USA

Contract ID 0000000000000000000029018	Page 3 of 4
Contract Dates 06/30/2015 to 06/30/2018	Origin CPS
Description: SNOWPLOW BLADE CUTTING EDGES	Contract Maximum \$9,999,990.00
Buyer Name Smith, Steven D	Buyer Phone 828-4681
	Contract Status Approved

Phone #: 717-766-0711

Line #	Item ID	Item Desc	UOM	Unit Price	Max Qty	Max Amt
--------	---------	-----------	-----	------------	---------	---------

VERMONT STATE COLLEGES: THIS CONTRACT IS ALSO AVAILABLE FOR USE BY THE UNIVERSITY OF VERMONT AND THE VERMONT STATE COLLEGES INC., A SEPARATE CORPORATION, HAVING UNDER ITS JURISDICTION CASTLETON STATE COLLEGE, JOHNSON STATE COLLEGE, LYNDON STATE COLLEGE, COMMUNITY COLLEGE OF VERMONT, AND THE VERMONT TECHNICAL COLLEGE.

TOWNS AND SCHOOLS OF THE STATE OF VERMONT: AT THE BIDDER'S ELECTION POLITICAL SUBDIVISIONS AND INDEPENDENT COLLEGES OF THE STATE MAY PARTICIPATE IN STATE CONTRACTS AT THE SAME PRICES, TERMS AND CONDITIONS. ITEMS FURNISHED TO POLITICAL SUBDIVISIONS AND INDEPENDENT COLLEGES WILL BE BILLED DIRECTLY TO AND PAID FOR BY THE POLITICAL SUBDIVISIONS OR INDEPENDENT COLLEGES AND NEITHER THE STATE NOR ITS COMMISSIONER OF BUILDINGS AND GENERAL SERVICES PERSONALLY OR OFFICIALLY ASSUMES ANY RESPONSIBILITY FOR THESE PAYMENTS.

AGENCIES & DEPARTMENTS ARE REQUESTED TO ADVISE THE PURCHASING AGENT AT ONCE OF THE FAILURE ON THE PART OF THE CONTRACTOR TO FULFILL ANY OF THE TERMS OR CONDITIONS OF THIS CONTRACT.

PLEASE REFER TO THE ASSIGNED CONTRACT NUMBER/PURCHASE ORDER # ON ALL CORRESPONDENCE, DELIVERY DOCUMENTS AND INVOICES.

APRIL 7, 2017

AMENDMENT #01 - TO EXTEND CONTRACT FOR A ONE YEAR PERIOD AT THE SAME PRICES, TERMS AND CONDITIONS.

ATTACHMENT C: ATTACHMENT C: STANDARD STATE CONTRACT PROVISIONS FOR CONTRACTS AND GRANTS DATED JULY 1, 2016 SEE ATTACHED, WHICH SUPERSEDES ALL PRIOR VERSIONS OF ATTACHMENT C.

CONTRACTOR CERTIFIES UNDER THE PAINS AND PENALTIES OF PERJURY THAT, AS OF THE DATE THIS CONTRACT AMENDMENT IS SIGNED, CONTRACTOR IS IN GOOD STANDING WITH RESPECT TO, OR IN FULL COMPLIANCE WITH A PLAN TO PAY ANY AND ALL TAXES DUE THE STATE OF VERMONT

CERTIFICATION REGARDING SUSPENSION OR DEBARMENT. CONTRACTOR CERTIFIES UNDER THE PAINS AND PENALTIES OF PERJURY THAT, AS OF THIS DATE THIS CONTRACT AMENDMENT IS SIGNED, NEITHER PARTY NO PARTY'S PRINCIPALS (OFFICERS, DIRECTORS, OWNERS, OR PARTNERS) ARE PRESENTLY DEBARRED, SUSPENDED, PROPOSED FOR DEBARMENT, DECLARED INELIGIBLE OR EXCLUDED FROM PARTICIPATION IN FEDERAL PROGRAMS, OR PROGRAMS SUPPORTED IN WHOLE OR IN PART BY FEDERAL FUNDS.

PARTY FURTHER CERTIFIES UNDER PAINS AND PENALTIES OF PERJURY THAT, AS OF THE DATE THIS AGREEMENT IS SIGNED, PARTY IS NOT PRESENTLY DEBARRED, SUSPENDED, NOR NAMED ON THE STATE'S DEBARMENT LIST AT:
[HTTP://BGS.VERMONT.GOV/PURCHASING/DEBARMENT](http://BGS.VERMONT.GOV/PURCHASING/DEBARMENT) .

CHILD SUPPORT (APPLICABLE TO NATURAL PERSONS ONLY; NOT APPLICABLE TO CORPORATIONS, PARTNERSHIPS OR LLCs): CONTRACTOR IS UNDER NO OBLIGATION TO PAY CHILD SUPPORT OR IS IN GOOD STANDING WITH RESPECT TO OR IN FULL COMPLIANCE WITH A PLAN TO PAY ANY AND ALL CHILD SUPPORT PAYABLE UNDER A SUPPORT ORDER AS OF THE DATE OF THIS AMENDMENT.

CONTRACT

State of Vermont
Buildings and General Services
Office of Purchasing & Contracting
109 State St
Montpelier VT 05609-3001
USA



Vendor ID 0000010383
Valk Manufacturing Co
PO Box 428
New Kingstown PA 17072-0428
USA

Contract ID		Page
000000000000000000029018		4 of 4
Contract Dates		Origin
06/30/2015 to 06/30/2016		CPS
Description:		Contract Maximum
SNOWPLOW BLADE CUTTING EDGES		\$9,999,990.00
Buyer Name	Buyer Phone	Contract Status
Smith, Steven D	828-4681	Approved

Phone #: 717-766-0711

Line #	Item ID	Item Desc	UOM	Unit Price	Max Qty	Max Amt
WE THE UNDERSIGNED PARTIES AGREE TO BE BOUND BY THIS CONTRACT						

By the STATE of VERMONT

Date: _____
Signature: e-Signed by Jennifer Fitch
on 2017-07-11 18:20:20 GMT

Name: Christopher Cole

Commissioner
Title: Buildings & General Services

Email: _____

By the CONTRACTOR

Date: 7/5/17
Signature: *Robert P. Lang*
Name: Robert P. Lang

Title: Vice President

Email: rlang@valkmfg.com

**ATTACHMENT C: STANDARD STATE PROVISIONS
FOR CONTRACTS AND GRANTS
REVISED JULY 1, 2016**

1. Definitions: For purposes of this Attachment, "Party" shall mean the Contractor, Grantee or Subrecipient, with whom the State of Vermont is executing this Agreement and consistent with the form of the Agreement. "Agreement" shall mean the specific contract or grant to which this form is attached.

2. Entire Agreement: This Agreement, whether in the form of a Contract, State Funded Grant, or Federally Funded Grant, represents the entire agreement between the parties on the subject matter. All prior agreements, representations, statements, negotiations, and understandings shall have no effect.

3. Governing Law, Jurisdiction and Venue; No Waiver of Jury Trial: This Agreement will be governed by the laws of the State of Vermont. Any action or proceeding brought by either the State or the Party in connection with this Agreement shall be brought and enforced in the Superior Court of the State of Vermont, Civil Division, Washington Unit. The Party irrevocably submits to the jurisdiction of this court for any action or proceeding regarding this Agreement. The Party agrees that it must first exhaust any applicable administrative remedies with respect to any cause of action that it may have against the State with regard to its performance under the Agreement.

Party agrees that the State shall not be required to submit to binding arbitration or waive its right to a jury trial.

4. Sovereign Immunity: The State reserves all immunities, defenses, rights or actions arising out of the State's sovereign status or under the Eleventh Amendment to the United States Constitution. No waiver of the State's immunities, defenses, rights or actions shall be implied or otherwise deemed to exist by reason of the State's entry into this Agreement.

5. No Employee Benefits For Party: The Party understands that the State will not provide any individual retirement benefits, group life insurance, group health and dental insurance, vacation or sick leave, workers compensation or other benefits or services available to State employees, nor will the state withhold any state or federal taxes except as required under applicable tax laws, which shall be determined in advance of execution of the Agreement. The Party understands that all tax returns required by the Internal Revenue Code and the State of Vermont, including but not limited to income, withholding, sales and use, and rooms and meals, must be filed by the Party, and information as to Agreement income will be provided by the State of Vermont to the Internal Revenue Service and the Vermont Department of Taxes.

6. Independence: The Party will act in an independent capacity and not as officers or employees of the State.

7. Defense and Indemnity: The Party shall defend the State and its officers and employees against all third party claims or suits arising in whole or in part from any act or omission of the Party or of any agent of the Party in connection with the performance of this Agreement. The State shall notify the Party in the event of any such claim or suit, and the Party shall immediately retain counsel and otherwise provide a complete defense against the entire claim or suit. The State retains the right to participate at its own expense in the defense of any claim. The State shall have the right to approve all proposed settlements of such claims or suits. In the event the State withholds approval to settle any such claim, then the Party shall proceed with the defense of the claim but under those circumstances, the Party's indemnification obligations shall be limited to the amount of the proposed settlement initially rejected by the State.

After a final judgment or settlement the Party may request recoupment of specific defense costs and may file suit in Washington Superior Court requesting recoupment. The Party shall be entitled to recoup costs only upon a showing that such costs were entirely unrelated to the defense of any claim arising from an act or omission of the Party in connection with the performance of this Agreement.

The Party shall indemnify the State and its officers and employees in the event that the State, its officers or employees become legally obligated to pay any damages or losses arising from any act or omission of the Party or an agent of the Party in connection with the performance of this Agreement.

The Party agrees that in no event shall the terms of this Agreement nor any document required by the Party in connection with its performance under this Agreement obligate the State to defend or indemnify the Party or otherwise be liable for the expenses or reimbursement, including attorneys' fees, collection costs or other costs of the Party except to the extent awarded by a court of competent jurisdiction.

8. Insurance: Before commencing work on this Agreement the Party must provide certificates of insurance to show that the following minimum coverages are in effect. It is the responsibility of the Party to maintain current certificates of insurance on file with the State through the term of the Agreement. No warranty is made that the coverages and limits listed herein are adequate to cover and protect the interests of the Party for the Party's operations. These are solely minimums that have been established to protect the interests of the State.

Workers Compensation: With respect to all operations performed, the Party shall carry workers' compensation insurance in accordance with the laws of the State of Vermont. Vermont will accept an out-of-state employer's workers' compensation coverage while operating in Vermont provided that the insurance carrier is licensed to write insurance in Vermont and an amendatory endorsement is added to the policy adding Vermont for coverage purposes. Otherwise, the party shall secure a Vermont workers' compensation policy, if necessary to comply with Vermont law.

General Liability and Property Damage: With respect to all operations performed under this Agreement, the Party shall carry general liability insurance having all major divisions of coverage including, but not limited to:

Premises - Operations

Products and Completed Operations

Personal Injury Liability

Contractual Liability

The policy shall be on an occurrence form and limits shall not be less than:

\$1,000,000 Each Occurrence

\$2,000,000 General Aggregate

\$1,000,000 Products/Completed Operations Aggregate

\$1,000,000 Personal & Advertising Injury

Automotive Liability: The Party shall carry automotive liability insurance covering all motor vehicles, including hired and non-owned coverage, used in connection with the Agreement. Limits of coverage shall not be less than \$500,000 combined single limit. If performance of this Agreement involves construction, or the transport of persons or hazardous materials, limits of coverage shall not be less than \$1,000,000 combined single limit.

Additional Insured. The General Liability and Property Damage coverages required for performance of this Agreement shall include the State of Vermont and its agencies, departments, officers and employees as Additional Insureds. If performance of this Agreement involves construction, or the transport of persons or hazardous materials, then the required Automotive Liability coverage shall include the State of Vermont and its agencies, departments, officers and employees as Additional Insureds. Coverage shall be primary and non-contributory with any other insurance and self-insurance.

Notice of Cancellation or Change. There shall be no cancellation, change, potential exhaustion of aggregate limits or non-renewal of insurance coverage(s) without thirty (30) days written prior written notice to the State.

9. Reliance by the State on Representations: All payments by the State under this Agreement will be made in reliance upon the accuracy of all representations made by the Party in accordance with the Contract, including but not limited to bills, invoices, progress reports and other proofs of work.

10. False Claims Act: The Party acknowledges that it is subject to the Vermont False Claims Act as set forth in 32 V.S.A. § 630 *et seq.* If the Party violates the Vermont False Claims Act it shall be liable to the State for civil penalties, treble damages and the costs of the investigation and prosecution of such violation, including attorney's fees, except as the same may be reduced by a court of competent jurisdiction. The Party's liability to the State under the False Claims Act shall not be limited notwithstanding any agreement of the State to otherwise limit Party's liability.

11. Whistleblower Protections: The Party shall not discriminate or retaliate against one of its employees or agents for disclosing information concerning a violation of law, fraud, waste, abuse of authority or acts threatening health or safety, including but not limited to allegations concerning the False Claims Act. Further, the Party shall not require such employees or agents to forego monetary awards as a result of such disclosures, nor should they be required to report misconduct to the Party or its agents prior to reporting to any governmental entity and/or the public.

12. Federal Requirements Pertaining to Grants and Subrecipient Agreements:

- A. Requirement to Have a Single Audit:** In the case that this Agreement is a Grant that is funded in whole or in part by federal funds, the Subrecipient will complete the Subrecipient Annual Report annually within 45 days after its fiscal year end, informing the State of Vermont whether or not a Single Audit is required for the prior fiscal year. If a Single Audit is required, the Subrecipient will submit a copy of the audit report to the granting Party within 9 months. If a single audit is not required, only the Subrecipient Annual Report is required.

For fiscal years ending before December 25, 2015, a Single Audit is required if the subrecipient expends \$500,000 or more in federal assistance during its fiscal year and must be conducted in accordance with OMB Circular A-133. For fiscal years ending on or after December 25, 2015, a Single Audit is required if the subrecipient expends \$750,000 or more in federal assistance during its fiscal year and must be conducted in accordance with 2 CFR Chapter I, Chapter II, Part 200, Subpart F. The Subrecipient Annual Report is required to be submitted within 45 days, whether or not a Single Audit is required.

- B. Internal Controls:** In the case that this Agreement is a Grant that is funded in whole or in part by Federal funds, in accordance with 2 CFR Part II, §200.303, the Party must establish and maintain effective internal control over the Federal award to provide reasonable assurance that the Party is managing the Federal award in compliance with Federal statutes, regulations, and the terms and conditions of the award. These internal controls should be in compliance with guidance in "Standards for Internal Control in the Federal Government" issued by the Comptroller General of the United States and the "Internal Control Integrated Framework", issued by the Committee of Sponsoring Organizations of the Treadway Commission (COSO).

- C. Mandatory Disclosures:** In the case that this Agreement is a Grant funded in whole or in part by Federal funds, in accordance with 2CFR Part II, §200.113, Party must disclose, in a timely manner, in writing to the State, all violations of Federal criminal law involving fraud, bribery, or gratuity violations potentially affecting the Federal award. Failure to make required disclosures may result in the imposition of sanctions which may include disallowance of costs incurred, withholding of payments, termination of the Agreement, suspension/debarment, etc.

13. Records Available for Audit: The Party shall maintain all records pertaining to performance under this agreement. "Records" means any written or recorded information, regardless of physical form or characteristics, which is produced or acquired by the Party in the performance of this agreement. Records produced or acquired

in a machine readable electronic format shall be maintained in that format. The records described shall be made available at reasonable times during the period of the Agreement and for three years thereafter or for any period required by law for inspection by any authorized representatives of the State or Federal Government. If any litigation, claim, or audit is started before the expiration of the three-year period, the records shall be retained until all litigation, claims or audit findings involving the records have been resolved.

14. Fair Employment Practices and Americans with Disabilities Act: Party agrees to comply with the requirement of 21 V.S.A. Chapter 5, Subchapter 6, relating to fair employment practices, to the full extent applicable. Party shall also ensure, to the full extent required by the Americans with Disabilities Act of 1990, as amended, that qualified individuals with disabilities receive equitable access to the services, programs, and activities provided by the Party under this Agreement.

15. Set Off: The State may set off any sums which the Party owes the State against any sums due the Party under this Agreement; provided, however, that any set off of amounts due the State of Vermont as taxes shall be in accordance with the procedures more specifically provided hereinafter.

16. Taxes Due to the State:

- A. Party understands and acknowledges responsibility, if applicable, for compliance with State tax laws, including income tax withholding for employees performing services within the State, payment of use tax on property used within the State, corporate and/or personal income tax on income earned within the State.
- B. Party certifies under the pains and penalties of perjury that, as of the date the Agreement is signed, the Party is in good standing with respect to, or in full compliance with, a plan to pay any and all taxes due the State of Vermont.
- C. Party understands that final payment under this Agreement may be withheld if the Commissioner of Taxes determines that the Party is not in good standing with respect to or in full compliance with a plan to pay any and all taxes due to the State of Vermont.
- D. Party also understands the State may set off taxes (and related penalties, interest and fees) due to the State of Vermont, but only if the Party has failed to make an appeal within the time allowed by law, or an appeal has been taken and finally determined and the Party has no further legal recourse to contest the amounts due.

17. Taxation of Purchases: All State purchases must be invoiced tax free. An exemption certificate will be furnished upon request with respect to otherwise taxable items.

18. Child Support: (Only applicable if the Party is a natural person, not a corporation or partnership.) Party states that, as of the date the Agreement is signed, he/she:

- A. is not under any obligation to pay child support; or
- B. is under such an obligation and is in good standing with respect to that obligation; or
- C. has agreed to a payment plan with the Vermont Office of Child Support Services and is in full compliance with that plan.

Party makes this statement with regard to support owed to any and all children residing in Vermont. In addition, if the Party is a resident of Vermont, Party makes this statement with regard to support owed to any and all children residing in any other state or territory of the United States.

19. Sub-Agreements: Party shall not assign, subcontract or subgrant the performance of this Agreement or any portion thereof to any other Party without the prior written approval of the State. Party shall be responsible and

liable to the State for all acts or omissions of subcontractors and any other person performing work under this Agreement pursuant to an agreement with Party or any subcontractor.

In the case this Agreement is a contract with a total cost in excess of \$250,000, the Party shall provide to the State a list of all proposed subcontractors and subcontractors' subcontractors, together with the identity of those subcontractors' workers compensation insurance providers, and additional required or requested information, as applicable, in accordance with Section 32 of The Vermont Recovery and Reinvestment Act of 2009 (Act No. 54).

Party shall include the following provisions of this Attachment C in all subcontracts for work performed solely for the State of Vermont and subcontracts for work performed in the State of Vermont: Section 10 ("False Claims Act"); Section 11 ("Whistleblower Protections"); Section 14 ("Fair Employment Practices and Americans with Disabilities Act"); Section 16 ("Taxes Due the State"); Section 18 ("Child Support"); Section 20 ("No Gifts or Gratuities"); Section 22 ("Certification Regarding Debarment"); Section 23 ("Certification Regarding Use of State Funds"); Section 31 ("State Facilities"); and Section 32 ("Location of State Data").

20. No Gifts or Gratuities: Party shall not give title or possession of anything of substantial value (including property, currency, travel and/or education programs) to any officer or employee of the State during the term of this Agreement.

21. Copies: Party shall use reasonable best efforts to ensure that all written reports prepared under this Agreement are printed using both sides of the paper.

22. Certification Regarding Debarment: Party certifies under pains and penalties of perjury that, as of the date that this Agreement is signed, neither Party nor Party's principals (officers, directors, owners, or partners) are presently debarred, suspended, proposed for debarment, declared ineligible or excluded from participation in federal programs, or programs supported in whole or in part by federal funds.

Party further certifies under pains and penalties of perjury that, as of the date that this Agreement is signed, Party is not presently debarred, suspended, nor named on the State's debarment list at: <http://bgs.vermont.gov/purchasing/debarment>

23. Certification Regarding Use of State Funds: In the case that Party is an employer and this Agreement is a State Funded Grant in excess of \$1,001, Party certifies that none of these State funds will be used to interfere with or restrain the exercise of Party's employee's rights with respect to unionization.

24. Conflict of Interest: Party shall fully disclose, in writing, any conflicts of interest or potential conflicts of interest.

25. Confidentiality: Party acknowledges and agrees that this Agreement and any and all information obtained by the State from the Party in connection with this Agreement are subject to the State of Vermont Access to Public Records Act, 1 V.S.A. § 315 et seq.

26. Force Majeure: Neither the State nor the Party shall be liable to the other for any failure or delay of performance of any obligations under this Agreement to the extent such failure or delay shall have been wholly or principally caused by acts or events beyond its reasonable control rendering performance illegal or impossible (excluding strikes or lock-outs) ("Force Majeure"). Where Force Majeure is asserted, the nonperforming party must prove that it made all reasonable efforts to remove, eliminate or minimize such cause of delay or damages, diligently pursued performance of its obligations under this Agreement, substantially fulfilled all non-excused obligations, and timely notified the other party of the likelihood or actual occurrence of an event described in this paragraph.

27. Marketing: Party shall not refer to the State in any publicity materials, information pamphlets, press releases, research reports, advertising, sales promotions, trade shows, or marketing materials or similar communications to third parties except with the prior written consent of the State.

28. Termination: In addition to any right of the State to terminate for convenience, the State may terminate this Agreement as follows:

- A. Non-Appropriation:** If this Agreement extends into more than one fiscal year of the State (July 1 to June 30), and if appropriations are insufficient to support this Agreement, the State may cancel at the end of the fiscal year, or otherwise upon the expiration of existing appropriation authority. In the case that this Agreement is a Grant that is funded in whole or in part by federal funds, and in the event federal funds become unavailable or reduced, the State may suspend or cancel this Grant immediately, and the State shall have no obligation to pay Subrecipient from State revenues.
- B. Termination for Cause:** Either party may terminate this Agreement if a party materially breaches its obligations under this Agreement, and such breach is not cured within thirty (30) days after delivery of the non-breaching party's notice or such longer time as the non-breaching party may specify in the notice.
- C. No Implied Waiver of Remedies:** A party's delay or failure to exercise any right, power or remedy under this Agreement shall not impair any such right, power or remedy, or be construed as a waiver of any such right, power or remedy. All waivers must be in writing.

29. Continuity of Performance: In the event of a dispute between the Party and the State, each party will continue to perform its obligations under this Agreement during the resolution of the dispute until this Agreement is terminated in accordance with its terms.

30. Termination Assistance: Upon nearing the end of the final term or termination of this Agreement, without respect to cause, the Party shall take all reasonable and prudent measures to facilitate any transition required by the State. All State property, tangible and intangible, shall be returned to the State upon demand at no additional cost to the State in a format acceptable to the State.

31. State Facilities: If the State makes space available to the Party in any State facility during the term of this Agreement for purposes of the Party's performance under this Agreement, the Party shall only use the space in accordance with all policies and procedures governing access to and use of State facilities which shall be made available upon request. State facilities will be made available to Party on an "AS IS, WHERE IS" basis, with no warranties whatsoever.

32. Location of State Data: No State data received, obtained, or generated by the Party in connection with performance under this Agreement shall be processed, transmitted, stored, or transferred by any means outside continental United States, except with the express written permission of the State.

(End of Standard Provisions)

CONTRACT

State of Vermont

Buildings and General Services
Office of Purchasing & Contracting
10 Baldwin St
Montpelier VT 05633-7501
USA



Vendor ID 0000010383
Valk Manufacturing Co
PO Box 428
New Kingstown PA 17072-0428
USA

Contract ID 000000000000000000029018	Page 1 of 3	
Contract Dates 06/30/2015 to 06/30/2017	Origin CPS	
Description: SNOWPLOW BLADE CUTTING EDGES	Contract Maximum \$9,999,990.00	
Buyer Name Smith, Steven D	Buyer Phone 828-4681	Contract Status Approved

Phone #: 717-766-0711

Line #	Item ID	Item Desc	UOM	Unit Price	Max Qty	Max Amt
1		SNOWPLOW BLADE CUTTING EDGES	EA	0.01000	0.00	0.00

BLADES AND PRICES PER THE ATTACHED LIST

STANDARD CONTRACT FOR SNOWPLOWBLADE CUTTING EDGES

1. Parties. This is a contract for services between the State of Vermont, Office of Purchasing and Contracting (hereafter called "State"), and Valk Manufacturing, with the principal place of business in New Kingstown, PA 07072, (hereafter called "Contractor"). Contractor's form of business organization is Corporation. It is the contractor's responsibility to contact the Vermont Department of Taxes to determine if, by law, the contractor is required to have a Vermont Department of Taxes Business Account Number.

2. Subject Matter. The subject matter of this contract is services generally on the subject of Snowplow Blade Cutting Edges.

3. Contract Term. The period of contractor's performance shall begin on June 30, 2015 and end on June 30, 2017, with option to renew for five (5) one year periods.

If the state exercises the option, it will provide written notice to contractor prior to the end of the term. If exercised, the provision of the option letter shall become part of and be incorporated into the original master price agreement. The total duration of this master price agreement, including the exercise of any options, shall not exceed five years.

4. Prior Approvals. If approval by the Attorney General's Office or the Secretary of Administration is required, (under current law, bulletins, and interpretations), neither this contract nor any amendment to it is binding until it has been approved by either or both such persons.

- Approval by the Attorney General's Office is required.
- Approval by the Secretary of Administration is required.
- Approval by the CIO/Commissioner DII is not required.

5. Amendment. This agreement represents the entire agreement between the parties; No changes, modifications, or amendments in the terms and conditions of this contract shall be effective unless reduced to writing, numbered and signed by the duly authorized representative of the State and Contractor.

6. Cancellation. This contract may be canceled by either party by giving written notice at least thirty (30) days in advance.

7. Attachments. This contract consists of 160 pages including the following attachments which are incorporated herein:

- Attachment A - Master Agreement Terms and Conditions
- Attachment B - Payment Provisions
- Attachment B1-Price Schedule
- Attachment C - "Standard State Provisions for Contracts and Grants" a preprinted form (revision date March 1, 2015).
- Attachment D - Snowplow Blade Cutting Edges Detailed Specifications

8. Order of Precedence. Any ambiguity, conflict or inconsistency in the Contract Documents shall be resolved according to the following order of precedence:

- (1) Standard Contract
- (2) Attachment C (Standard Contract Provisions for Contracts and Grants)
- (3) Attachment A
- (4) Attachment D
- (5) Attachment B
- (6) Attachment B1

CONTRACT

State of Vermont

Buildings and General Services
Office of Purchasing & Contracting
10 Baldwin St
Montpelier VT 05633-7501
USA



Vendor ID 0000010383
Valk Manufacturing Co
PO Box 428
New Kingstown PA 17072-0428
USA

Contract ID 0000000000000000000029018	Page 2 of 3
Contract Dates 06/30/2015 to 06/30/2017	Origin CPS
Description: SNOWPLOW BLADE CUTTING EDGES	Contract Maximum \$9,999,990.00
Buyer Name Smith, Steven D	Buyer Phone 828-4681
	Contract Status Approved

Phone #: 717-766-0711

Line #	Item ID	Item Desc.	UOM	Unit Price	Max Qty	Max Amt
--------	---------	------------	-----	------------	---------	---------

IF YOU HAVE ANY QUESTIONS REGARDING THIS DOCUMENT PLEASE CONTACT:

STEVE SMITH
PURCHASING AGENT
802-828-4681
FAX 802-828-2222
steven.smith@state.vt.us

QUANTITY: THE ANNUAL VALUE AND QUANTITIES ARE ESTIMATED ONLY BASED ON PRIOR USAGE; ACTUAL PURCHASES MAY BE HIGHER OR LOWER DEPENDING ON THE STATE'S NEEDS. THE CONTRACT MAXIMUM IS NOT REFLECTIVE OF ACTUAL USAGE.

DELIVERY: RESPONSIBILITY FOR PRODUCT DELIVERY REMAINS WITH THE CONTRACTOR UNTIL THE PRODUCT IS PROPERLY DELIVERED AND SIGNED FOR IN ACCORDANCE WITH THE OFFICE OF PURCHASING & CONTRACTING TERMS AND CONDITIONS. SHIPMENTS SHALL BE SECURELY AND PROPERLY PACKED, ACCORDING TO ACCEPTED COMMERCIAL PRACTICES, WITHOUT EXTRA CHARGE FOR PACKING CASES OR OTHER CONTAINERS. SUCH CONTAINERS WILL REMAIN THE PROPERTY OF THE STATE UNLESS OTHERWISE STATED. DELIVERED GOODS THAT DO NOT CONFORM TO THE SPECIFICATIONS OR ARE NOT IN GOOD CONDITION UPON RECEIPT SHALL BE REPLACED PROMPTLY BY THE CONTRACTOR.

PRICING: ALL EQUIPMENT PRICING IS TO INCLUDE F.O.B. DELIVERY TO THE ORDERING FACILITY. NO REQUEST FOR EXTRA DELIVERY COST WILL BE HONORED. ALL EQUIPMENT SHALL BE DELIVERED ASSEMBLED, SERVICED, OILED, AND READY FOR IMMEDIATE USE, UNLESS OTHERWISE REQUESTED BY THE PURCHASING AGENCY.

QUALITY: ALL PRODUCTS PROVIDED UNDER THESE AGREEMENTS WILL BE NEW AND UNUSED, UNLESS OTHERWISE STATED. FACTORY SECONDS OR REMANUFACTURED PRODUCTS WILL NOT BE ACCEPTED UNLESS SPECIFICALLY REQUESTED BY THE PURCHASING AGENCY. ALL PRODUCTS PROVIDED BY THE CONTRACTOR MUST MEET ALL FEDERAL, STATE, AND LOCAL STANDARDS FOR QUALITY AND SAFETY REQUIREMENTS. PRODUCTS NOT MEETING THESE STANDARDS WILL BE DEEMED UNACCEPTABLE AND RETURNED TO THE CONTRACTOR FOR CREDIT AT NO CHARGE TO THE STATE.

METHOD OF ORDERING: PURCHASE ORDERS MUST BE USED TO ORDER ITEMS AVAILABLE UNDER THIS CONTRACT. IF VERBAL ORDERS ARE GIVEN A CONFIRMING PURCHASE ORDER MUST BE ISSUED.

INVOICING: ALL INVOICES ARE TO BE RENDERED BY THE CONTRACTOR ON THE VENDOR'S STANDARD BILLHEAD AND FORWARDED DIRECTLY TO THE INSTITUTION OR AGENCY ORDERING MATERIALS OR SERVICES AND SHALL SPECIFY THE ADDRESS TO WHICH PAYMENTS WILL BE SENT.

CANCELLATION: THE STATE SPECIFICALLY RESERVES THE RIGHT TO CANCEL THE CONTRACT, OR ANY PORTION THEREOF, IF, IN THE OPINION OF ITS COMMISSIONER OF BUILDINGS AND GENERAL SERVICES, THE SERVICES OR MATERIALS SUPPLIED BY THE CONTRACTOR ARE NOT SATISFACTORY OR ARE NOT CONSISTENT WITH THE TERMS OF THE CONTRACT

DEFAULT: IN CASE OF DEFAULT OF THE CONTRACTOR, THE STATE MAY PROCURE THE MATERIALS OR SUPPLIES FROM OTHER SOURCES AND HOLD THE CONTRACTOR RESPONSIBLE FOR ANY EXCESS COST OCCASIONED THEREBY, PROVIDED, THAT IF PUBLIC NECESSITY REQUIRES THE USE OF MATERIALS OR SUPPLIES NOT CONFORMING TO THE SPECIFICATIONS THEY MAY BE ACCEPTED AND PAYMENT THEREFORE SHALL BE MADE AT A PROPER REDUCTION IN PRICE.

CONTRACT TERMS: THIS CONTRACT WILL BE SUBJECT TO REVIEW THROUGHOUT ITS TERM. THE STATE WILL CONSIDER CANCELLATION UPON DISCOVERY THAT A VENDOR IS IN VIOLATION OF ANY PORTION OF THE AGREEMENT, INCLUDING AN INABILITY BY THE VENDOR TO PROVIDE THE PRODUCTS, SUPPORT, AND/OR SERVICE OFFERED IN THEIR RESPONSE.

VERMONT STATE COLLEGES: THIS CONTRACT IS ALSO AVAILABLE FOR USE BY THE UNIVERSITY OF VERMONT AND THE VERMONT STATE COLLEGES INC., A SEPARATE CORPORATION, HAVING UNDER ITS JURISDICTION CASTLETON STATE COLLEGE, JOHNSON STATE COLLEGE, LYNDON STATE COLLEGE, COMMUNITY COLLEGE OF VERMONT, AND THE VERMONT TECHNICAL COLLEGE.

TOWNS AND SCHOOLS OF THE STATE OF VERMONT: AT THE BIDDER'S ELECTION POLITICAL SUBDIVISIONS AND INDEPENDENT COLLEGES OF THE STATE MAY PARTICIPATE IN STATE CONTRACTS AT THE SAME PRICES, TERMS AND CONDITIONS. ITEMS FURNISHED TO POLITICAL SUBDIVISIONS AND INDEPENDENT COLLEGES WILL BE BILLED DIRECTLY TO AND PAID FOR BY THE POLITICAL SUBDIVISIONS OR INDEPENDENT COLLEGES AND NEITHER THE STATE NOR ITS COMMISSIONER OF BUILDINGS AND GENERAL SERVICES PERSONALLY OR OFFICIALLY ASSUMES ANY RESPONSIBILITY FOR THESE PAYMENTS.

CONTRACT TERMS AND ADDITIONAL INFORMATION

CONTRACT



State of Vermont

Buildings and General Services
Office of Purchasing & Contracting
10 Baldwin St
Montpelier VT 05633-7501
USA

Vendor ID 0000010383
Valk Manufacturing Co
PO Box 428
New Kingstown PA 17072-0428
USA

Contract ID		Page
000000000000000000029018		3 of 3
Contract Dates	Origin	
06/30/2015 to 06/30/2017	CPS	
Description:	Contract Maximum	
SNOWPLOW BLADE CUTTING EDGES	\$9,999,990.00	
Buyer Name	Buyer Phone	Contract Status
Smith, Steven D	828-4681	Approved

Phone #: 717-766-0711

Line #	Item ID	Item Desc	UOM	Unit Price	Max Qty	Max Amt
AGENCIES & DEPARTMENTS ARE REQUESTED TO ADVISE THE PURCHASING AGENT AT ONCE OF THE FAILURE ON THE PART OF THE CONTRACTOR TO FULFILL ANY OF THE TERMS OR CONDITIONS OF THIS CONTRACT.						

PLEASE REFER TO THE ASSIGNED CONTRACT NUMBER/PURCHASE ORDER # ON ALL CORRESPONDENCE, DELIVERY DOCUMENTS AND INVOICES.

WE THE UNDERSIGNED PARTIES AGREE TO BE BOUND BY THIS CONTRACT

By the STATE of VERMONT

Date: E-SIGNED by DEBORAH DAMORE
on 2015-07-24 16:11:33 GMT
Signature: _____
Name: Deborah Damore

Title: Director
Email: Purchasing & Contracting

By the CONTRACTOR

Date: July 16, 2015
Signature: [Handwritten Signature]
Name: Robert P. Lang

Title: Vice President
Email: rlang@valkmfq.com

ATTACHMENT A: MASTER AGREEMENT TERMS AND CONDITIONS

Scope of Work

Contractor to provide various types of snowplow cutting edges, in accordance with the attached detailed specifications, drawings and diagrams and prices lists to various state agencies and political subdivisions within Vermont and any NASPO VALUEPOINT (FORMERLY WSCA-NASPO) participating entity.

There are 12 individual blade category types as referenced in Attachment D

Overview:

The State of Vermont, Office of Purchasing & Contracting, was the lead state in a Request for Proposal on behalf of the State of Vermont and NASPO VALUEPOINT (FORMERLY WSCA-NASPO) Cooperative Procurement Program resulting in a Master Agreement Award. After evaluation by a multi-state sourcing team the solicitation resulted in Master Agreement with qualified manufacturers for various types of snowplow cutting edges.

Master Agreement Order of Precedence

a. For any Order placed under this Master Agreement, any conflict among these documents shall be resolved by giving priority to these documents in the order below:

- (1) A Participating Entity's Participating Addendum ("PA");
- (2) Except for Orders by the Lead State, this Attachment A;
- (3) Section 8, Order of Precedence, of the State of Vermont Contract;

b. These documents shall be read to be consistent and complementary. Any conflict among these documents shall be resolved by giving priority to these documents in the order listed above. Contractor terms and conditions that apply to this Master Agreement are only those that are expressly accepted by the Lead State and must be in writing and attached to this Master Agreement as an Exhibit or Attachment.

Term of the Master Agreement

The initial term of this Master Agreement is for Two years. This Master Agreement may be extended beyond the original contract period for Five additional years at the Lead State's

discretion and by mutual agreement and upon review of requirements of Participating Entities, current market conditions, and Contractor performance.

1. Amendments

The terms of this Master Agreement shall not be waived, altered, modified, supplemented or amended in any manner whatsoever without prior written approval of the Lead State Contract Administrator.

2. Assignment/Subcontracts

a. Contractor shall not assign, sell, transfer, subcontract or sublet rights, or delegate responsibilities under this Master Agreement, in whole or in part, without the prior written approval of the Lead State Contract Administrator.

b. The Lead State Contract Administrator reserves the right to assign any rights or duties, including written assignment of contract administration duties to the NASPO VALUEPOINT organization, FORMERLY WSCA-NASPO (hereafter "NASPO ValuePoint").

3. Cancellation

Unless otherwise stated, this Master Agreement may be canceled by either party upon 60 days written notice prior to the effective date of the cancellation. Further, any Participating State or other Participating Entity may cancel its participation upon 30 days written notice, unless otherwise limited or stated in the Participating Addendum. Cancellation may be in whole or in part. Any cancellation under this provision shall not affect the rights and obligations attending orders outstanding at the time of cancellation, including any right of and Purchasing Entity to indemnification by the Contractor, rights of payment for Products delivered and accepted, and rights attending any warranty or default in performance in association with any Order. Cancellation of the Master Agreement due to Contractor default may be immediate.

4. Confidentiality, Non-Disclosure, and Injunctive Relief

a. Confidentiality. Contractor acknowledges that it and its employees or agents may, in the course of providing a Product under this Master Agreement, be exposed to or acquire information that is confidential to Purchasing Entity's or Purchasing Entity's clients. Any and all information of any form that is marked as confidential or would by its nature be deemed confidential obtained by Contractor or its employees or agents in the performance of this Master Agreement, including, but not necessarily limited to (1) any Purchasing Entity's records, (2) personnel records, and (3) information concerning individuals, is confidential information of

Purchasing Entity (“Confidential Information”). Any reports or other documents or items (including software) that result from the use of the Confidential Information by Contractor shall be treated in the same manner as the Confidential Information. Confidential Information does not include information that (1) is or becomes (other than by disclosure by Contractor) publicly known; (2) is furnished by Purchasing Entity to others without restrictions similar to those imposed by this Master Agreement; (3) is rightfully in Contractor’s possession without the obligation of nondisclosure prior to the time of its disclosure under this Master Agreement; (4) is obtained from a source other than Purchasing Entity without the obligation of confidentiality, (5) is disclosed with the written consent of Purchasing Entity or; (6) is independently developed by employees, agents or subcontractors of Contractor who can be shown to have had no access to the Confidential Information.

b. Non-Disclosure. Contractor shall hold Confidential Information in confidence, using at least the industry standard of confidentiality, and shall not copy, reproduce, sell, assign, license, market, transfer or otherwise dispose of, give, or disclose Confidential Information to third parties or use Confidential Information for any purposes whatsoever other than what is necessary to the performance of Orders placed under this Master Agreement. Contractor shall advise each of its employees and agents of their obligations to keep Confidential Information confidential. Contractor shall use commercially reasonable efforts to assist Purchasing Entity in identifying and preventing any unauthorized use or disclosure of any Confidential Information. Without limiting the generality of the foregoing, Contractor shall advise Purchasing Entity, applicable Participating Entity, and the Lead State Contract Administrator immediately if Contractor learns or has reason to believe that any person who has had access to Confidential Information has violated or intends to violate the terms of this Master Agreement, and Contractor shall at its expense cooperate with Purchasing Entity in seeking injunctive or other equitable relief in the name of Purchasing Entity or Contractor against any such person. Except as directed by Purchasing Entity, Contractor will not at any time during or after the term of this Master Agreement disclose, directly or indirectly, any Confidential Information to any person, except in accordance with this Master Agreement, and that upon termination of this Master Agreement or at Purchasing Entity’s request, Contractor shall turn over to Purchasing Entity all documents, papers, and other matter in Contractor’s possession that embody Confidential Information. Notwithstanding the foregoing, Contractor may keep one copy of such Confidential Information necessary for quality assurance, audits and evidence of the performance of this Master Agreement.

c. Injunctive Relief. Contractor acknowledges that breach of this section, including disclosure of any Confidential Information, will cause irreparable injury to Purchasing Entity that is inadequately compensable in damages. Accordingly, Purchasing Entity may seek and obtain

injunctive relief against the breach or threatened breach of the foregoing undertakings, in addition to any other legal remedies that may be available. Contractor acknowledges and agrees that the covenants contained herein are necessary for the protection of the legitimate business interests of Purchasing Entity and are reasonable in scope and content.

d. Purchasing Entity Law. These provisions shall be applicable only to extent they are not in conflict with the applicable public disclosure laws of any Purchasing Entity.

5. Right to Publish

Throughout the duration of this Master Agreement, Contractor must secure from the Lead State Contract Administrator prior approval for the release of any information that pertains to the potential work or activities covered by the Master Agreement. The Contractor shall not make any representations of NASPO ValuePoint's opinion or position as to the quality or effectiveness of the services that are the subject of this Master Agreement without prior written consent. Failure to adhere to this requirement may result in termination of the Master Agreement for cause.

6. Defaults and Remedies

a. The occurrence of any of the following events shall be an event of default under this Master Agreement:

- (1) Nonperformance of contractual requirements; or
- (2) A material breach of any term or condition of this Master Agreement; or
- (3) Any certification, representation or warranty by Contractor in response to the solicitation or in this Master Agreement that proves to be untrue or materially misleading; or
- (4) Institution of proceedings under any bankruptcy, insolvency, reorganization or similar law, by or against Contractor, or the appointment of a receiver or similar officer for Contractor or any of its property, which is not vacated or fully stayed within thirty (30) calendar days after the institution or occurrence thereof; or
- (5) Any default specified in another section of this Master Agreement.

b. Upon the occurrence of an event of default, Lead State Contract Administrator shall issue a written notice of default, identifying the nature of the default, and providing a period of 15 calendar days in which Contractor shall have an opportunity to cure the default. The Lead State Contract Administrator shall not be required to provide advance written notice or a cure period and may immediately terminate this Master Agreement in whole or in part if the Lead State Contract Administrator, in its sole discretion, determines that it is reasonably necessary to preserve public safety or prevent immediate public crisis. Time allowed for cure shall not

diminish or eliminate Contractor's liability for damages, including liquidated damages to the extent provided for under this Master Agreement.

c. If Contractor is afforded an opportunity to cure and fails to cure the default within the period specified in the written notice of default, Contractor shall be in breach of its obligations under this Master Agreement and Lead State Contract Administrator shall have the right to exercise any or all of the following remedies:

- (1) Exercise any remedy provided by law; and
- (2) Terminate this Master Agreement and any related Contracts or portions thereof; and
- (3) Impose liquidated damages as provided in this Master Agreement; and
- (4) Suspend Contractor from being able to respond to future bid solicitations; and
- (5) Suspend Contractor's performance; and
- (6) Withhold payment until the default is remedied.

d. Unless other specified in the Participating Addendum, in the event of a default under a Participating Addendum, a Participating Entity shall provide a written notice of default as described in this section and have all of the rights and remedies under this paragraph regarding its participation in the Master Agreement, in addition to those set forth in its Participating Addendum. Unless otherwise specified in a Purchase Order, a Purchasing Entity shall provide written notice of default as described in this section and have all of the rights and remedies under this paragraph and any applicable Participating Addendum with respect to an Order placed by the Purchasing Entity. Nothing in these Master Agreement Terms and Conditions shall be construed to limit the rights and remedies available to a Purchasing Entity under the applicable commercial code.

7. Shipping and Delivery.

a. **DELIVERY:** Responsibility for product delivery remains with the contractor until the product is properly delivered and signed for in accordance with the Purchasing Entity terms and conditions. Shipments shall be securely and properly packed, according to accepted commercial practices, without extra charge for packing cases or other containers. Such containers will remain the property of the State unless otherwise stated. Delivered goods that do not conform to the specifications or are not in good condition upon receipt shall be replaced promptly by the contractor.

b. Cases shall be of durable construction, good condition, properly labeled and suitable in every respect for storage and handling of contents. Each shipping carton shall be marked with the commodity, brand, quantity, item code number and the Purchasing Entity's Purchase Order number.

8. Changes in Contractor Representation

The Contractor must notify the Lead State Contract Administrator of changes in the Contractor's key administrative personnel working on this Contract, in writing within 10 calendar days of the change. The Lead State Contract Administrator reserves the right to approve changes in key personnel working on this Contract. The Contractor agrees to propose replacement key personnel having substantially equal or better education, training, and experience as was possessed by the key person proposed by the Contractor in its bid and approved by the Lead State upon contract execution.

9. Force Majeure

Neither party to this Master Agreement shall be held responsible for delay or default caused by fire, riot, acts of God and/or war which is beyond that party's reasonable control. The Lead State Contract Administrator may terminate this Master Agreement after determining such delay or default will reasonably prevent successful performance of the Master Agreement.

10. Indemnification

a. The Contractor shall defend, indemnify and hold harmless NASPO ValuePoint, the Lead State Contract Administrator, Participating Entities, and Purchasing Entities, along with their officers, agents, and employees as well as any person or entity for which they may be liable, from and against claims, damages or causes of action including reasonable attorneys' fees and related costs for any death, injury, or damage to property arising from act(s), error(s), or omission(s) of the Contractor, its employees or subcontractors or volunteers, at any tier, relating to the performance under the Master Agreement.

b. Indemnification – Intellectual Property. The Contractor shall defend, indemnify and hold harmless NASPO ValuePoint, the Lead State Contract Administrator, Participating Entities, Purchasing Entities, along with their officers, agents, and employees as well as any person or entity for which they may be liable ("Indemnified Party"), from and against claims, damages or causes of action including reasonable attorneys' fees and related costs arising out of the claim that the Product or its use, infringes Intellectual Property rights ("Intellectual Property Claim").

(1) The Contractor's obligations under this section shall not extend to any combination of the Product with any other product, system or method, unless the Product, system or method is:

(a) provided by the Contractor or the Contractor's subsidiaries or affiliates;

(b) specified by the Contractor to work with the Product; or

(c) reasonably required, in order to use the Product in its intended manner, and the infringement could not have been avoided by substituting another reasonably available product, system or method capable of performing the same function; or

(d) It would be reasonably expected to use the Product in combination with such product, system or method.

(2) The Indemnified Party shall notify the Contractor within a reasonable time after receiving notice of an Intellectual Property Claim. Even if the Indemnified Party fails to provide reasonable notice, the Contractor shall not be relieved from its obligations unless the Contractor can demonstrate that it was prejudiced in defending the Intellectual Property Claim resulting in increased expenses or loss to the Contractor. If the Contractor promptly and reasonably investigates and defends any Intellectual Property Claim, it shall have control over the defense and settlement of it. However, the Indemnified Party must consent in writing for any money damages or obligations for which it may be responsible. The Indemnified Party shall furnish, at the Contractor's reasonable request and expense, information and assistance necessary for such defense. If the Contractor fails to vigorously pursue the defense or settlement of the Intellectual Property Claim, the Indemnified Party may assume the defense or settlement of it and the Contractor shall be liable for all costs and expenses, including reasonable attorneys' fees and related costs, incurred by the Indemnified Party in the pursuit of the Intellectual Property Claim. Unless otherwise agreed in writing, this section is not subject to any limitations of liability in this Master Agreement or in any other document executed in conjunction with this Master Agreement.

11. Independent Contractor

The Contractor shall be an independent contractor. Contractor shall have no authorization, express or implied, to bind the Lead State Contract Administrator, Participating States, other Participating Entities, or Purchasing Entities to any agreements, settlements, liability or understanding whatsoever, and agrees not to hold itself out as agent except as expressly set forth herein or as expressly agreed in any Participating Addendum.

12. Individual Customers

Except to the extent modified by a Participating Addendum, each Purchasing Entity shall follow the terms and conditions of the Master Agreement and applicable Participating Addendum and

will have the same rights and responsibilities for their purchases as the Lead State Contract Administrator has in the Master Agreement, including but not limited to, any indemnity or right to recover any costs as such right is defined in the Master Agreement and applicable Participating Addendum for their purchases. Each Purchasing Entity will be responsible for its own charges, fees, and liabilities. The Contractor will apply the charges and invoice each Purchasing Entity individually.

13. Insurance

a. The insurance requirements for the State of Vermont are specified in section 7 of Attachment C. Unless otherwise agreed in a Participating Addendum, Contractor shall, during the term of this Master Agreement, maintain in full force and effect, the insurance described in this section for other Participating Entities. Contractor shall acquire such insurance from an insurance carrier or carriers licensed to conduct business in each Participating Entity's state and having a rating of A-, Class VII or better, in the most recently published edition of Best's Reports. Failure to buy and maintain the required insurance may result in this Master Agreement's termination or, at a Participating Entity's option; result in termination of its Participating Addendum.

b. Coverage shall be written on an occurrence basis. The minimum acceptable limits shall be as indicated below, with no deductible for each of the following categories:

(1) Commercial General Liability covering premises operations, independent contractors, products and completed operations, blanket contractual liability, personal injury (including death), advertising liability, and property damage, with a limit of not less than \$1 million per occurrence/\$1 million general aggregate;

(2) Contractor must comply with any applicable State Workers Compensation or Employers Liability Insurance requirements.

c. Contractor shall pay premiums on all insurance policies. Such policies shall also reference this Master Agreement and shall have a condition that they not be revoked by the insurer until thirty (30) calendar days after notice of intended revocation thereof shall have been given to Purchasing Entity and Participating Entity by the Contractor.

d. Prior to commencement of performance, Contractor shall provide to the Lead State Contract Administrator a written endorsement to the Contractor's general liability insurance policy or

other documentary evidence acceptable to the Lead State Contract Administrator that (1) names the Participating States identified in the Request for Proposal as additional insureds, (2) provides that no material alteration, cancellation, non-renewal, or expiration of the coverage contained in such policy shall have effect unless the named Participating State has been given at least thirty (30) days prior written notice, and (3) provides that the Contractor's liability insurance policy shall be primary, with any liability insurance of any Participating State as secondary and noncontributory. Unless otherwise agreed in any Participating Addendum, the Participating Entity's rights and Contractor's obligations are the same as those specified in the first sentence of this subsection. Before performance of any Purchase Order issued after execution of a Participating Addendum authorizing it, the Contractor shall provide to a Purchasing Entity or Participating Entity who requests it the same information described in this subsection.

e. Contractor shall furnish to the Lead State Contract Administrator, Participating Entity, and, on request, the Purchasing Entity copies of certificates of all required insurance within thirty (30) calendar days of the execution of this Master Agreement, the execution of a Participating Addendum, or the Purchase Order's effective date and prior to performing any work. The insurance certificate shall provide the following information: the name and address of the insured; name, address, telephone number and signature of the authorized agent; name of the insurance company (authorized to operate in all states); a description of coverage in detailed standard terminology (including policy period, policy number, limits of liability, exclusions and endorsements); and an acknowledgment of the requirement for notice of cancellation. Copies of renewal certificates of all required insurance shall be furnished within thirty (30) days after any renewal date. These certificates of insurance must expressly indicate compliance with each and every insurance requirement specified in this section. Failure to provide evidence of coverage may, at sole option of the Lead State Contract Administrator, or any Participating Entity, result in this Master Agreement's termination or the termination of any Participating Addendum.

f. Coverage and limits shall not limit Contractor's liability and obligations under this Master Agreement, any Participating Addendum, or any Purchase Order.

14. Laws and Regulations

Any and all Products offered and furnished shall comply fully with all applicable Federal and State laws and regulations.

15. License of Pre-Existing Intellectual Property

Contractor grants to the Purchasing Entity a nonexclusive, perpetual, royalty-free, irrevocable, unlimited license to publish, translate, reproduce, modify, deliver, perform, display, and dispose of the Intellectual Property, and its derivatives, used or delivered under this Master Agreement,

but not created under it (“Pre-existing Intellectual Property”). The license shall be subject to any third party rights in the Pre-existing Intellectual Property. Contractor shall obtain, at its own expense, on behalf of the Purchasing Entity, written consent of the owner for the licensed Pre-existing Intellectual Property.

16. No Waiver of Sovereign Immunity

In no event shall this Master Agreement, any Participating Addendum or any contract or any Purchase Order issued thereunder, or any act of a Lead State, a Participating Entity, or a Purchasing Entity be a waiver of any form of defense or immunity, whether sovereign immunity, governmental immunity, immunity based on the Eleventh Amendment to the Constitution of the United States or otherwise, from any claim or from the jurisdiction of any court.

This section applies to a claim brought against the Participating State only to the extent Congress has appropriately abrogated the Participating State’s sovereign immunity and is not consent by the Participating State to be sued in federal court. This section is also not a waiver by the Participating State of any form of immunity, including but not limited to sovereign immunity and immunity based on the Eleventh Amendment to the Constitution of the United States.

17. Ordering

a. Master Agreement order and purchase order numbers shall be clearly shown on all acknowledgments, shipping labels, packing slips, invoices, and on all correspondence.

b. The resulting Master Agreements permit Purchasing Entities to define project-specific requirements and informally complete the requirement among companies having a Master Agreement on an “as needed” basis. This procedure may also be used when requirements are aggregated or other firm commitments may be made to achieve reductions in pricing. This procedure may be modified in Participating Addenda and adapted to Purchasing Entity rules and policies. The Purchasing Entity may in its sole discretion determine which Master Agreement Contractors should be solicited for a quote. The Purchasing Agency may select the quote that it considers most advantageous, cost and other factors considered.

c. Each Purchasing Entity will identify and utilize its own appropriate purchasing procedure and documentation. Contractor is expected to become familiar with the Purchasing Entities’ rules, policies, and procedures regarding the ordering of supplies and/or services contemplated by this Master Agreement.

d. Contractor shall not begin work without a valid Purchase Order or other appropriate commitment document compliance with the law of the Purchasing Entity.

e. Orders may be placed consistent with the terms of this Master Agreement during the term of the Master Agreement.

f. All Orders pursuant to this Master Agreement, at a minimum, shall include:

- (1) The services or supplies being delivered;
- (2) The place and requested time of delivery;
- (3) A billing address;
- (4) The name, phone number, and address of the Purchasing Entity representative;
- (5) The price per hour or other pricing elements consistent with this Master Agreement and the contractor's proposal;
- (6) A ceiling amount of the order for services being ordered; and
- (7) The Master Agreement identifier.

g. All communications concerning administration of Orders placed shall be furnished solely to the authorized purchasing agent within the Purchasing Entity's purchasing office, or to such other individual identified in writing in the Order.

h. Orders must be placed pursuant to this Master Agreement prior to the termination date thereof, but may have a delivery date or performance period up to 120 days past the then-current termination date of this Master Agreement. Contractor is reminded that financial obligations of Purchasing Entities payable after the current applicable fiscal year are contingent upon agency funds for that purpose being appropriated, budgeted, and otherwise made available.

i. Notwithstanding the expiration or termination of this Master Agreement, Contractor agrees to perform in accordance with the terms of any Orders then outstanding at the time of such

expiration or termination. Contractor shall not honor any Orders placed after the expiration or termination of this Master Agreement, or otherwise inconsistent with its terms. Orders from any separate indefinite quantity, task orders, or other form of indefinite delivery order arrangement priced against this Master Agreement may not be placed after the expiration or termination of this Master Agreement, notwithstanding the term of any such indefinite delivery order agreement.

18. Participants

a. Contractor may not deliver Products under this Master Agreement until a Participating Addendum acceptable to the Participating Entity and Contractor is executed. The NASPO ValuePoint Master Agreement Terms and Conditions are applicable to any Order by a Participating Entity (and other Purchasing Entities covered by their Participating Addendum), except to the extent altered, modified, supplemented or amended by a Participating Addendum. By way of illustration and not limitation, this authority may apply to unique delivery and invoicing requirements, confidentiality requirements, defaults on Orders, governing law and venue relating to Orders by a Participating Entity, indemnification, and insurance requirements. Statutory or constitutional requirements relating to availability of funds may require specific language in some Participating Addenda in order to comply with applicable law. The expectation is that these alterations, modifications, supplements, or amendments will be addressed in the Participating Addendum or, with the consent of the Purchasing Entity and Contractor, may be included in the ordering document (e.g. purchase order or contract) used by the Purchasing Entity to place the Order.

b. Use of specific NASPO ValuePoint cooperative Master Agreements by state agencies, political subdivisions and other Participating Entities (including cooperatives) authorized by individual state's statutes to use state contracts are subject to the approval of the respective State Chief Procurement Official. Issues of interpretation and eligibility for participation are solely within the authority of the respective State Chief Procurement Official.

c. Obligations under this Master Agreement are limited to those Participating Entities who have signed a Participating Addendum and Purchasing Entities within the scope of those Participating Addenda. Financial obligations of Participating States are limited to the orders placed by the departments or other state agencies and institutions having available funds. Participating States incur no financial obligations on behalf of political subdivisions.

d. NASPO ValuePoint is not a party to the Master Agreement. It is a nonprofit cooperative purchasing organization assisting states in administering the NASPO cooperative purchasing program for state government departments, institutions, agencies and political subdivisions (e.g.,

colleges, school districts, counties, cities, etc.) for all 50 states, the District of Columbia and the territories of the United States.

e. State Participating Addenda or other Participating Addenda shall not be construed to amend the terms of this Master Agreement between the Lead State Contract Administrator and Contractor. Participating Entities who execute a Participating Addendum may alter, modify, supplement or amend these NASPO ValuePoint Master Agreement Terms and Conditions as necessary to comply with Participating Entity law or policy with respect to their Orders (or Orders of Purchasing Entities encompassed by their Participating Addendum) under the Master Agreement.

f. Participating Entities who are not states may under some circumstances sign their own Participating Addendum, subject to the approval of the Chief Procurement Official of the state where the Participating Entity is located. Contractors may upon request obtain a copy of the written authorization from the Lead State Contract Administrator.

19. Payment

Payment for completion of a contract order will normally be made within 30 days following the date the entire order is delivered or the date a correct invoice is received, whichever is later. Payments will be remitted by mail. Payments may be made via a State or political subdivision "Purchasing Card" with no additional charge.

20. Public Information

This Master Agreement and all related documents are subject to disclosure pursuant to the State of Vermont's public information laws, and with respect to Participating Addenda and Orders, the Participating Entity's and Purchasing Entity's public information laws.

21. Records available for Audit

a. The Contractor shall maintain books, records, documents, and other evidence pertaining to this Master Agreement and orders placed by Purchasing Entities under it to the extent and in such detail as shall adequately reflect performance and administration of payments and fees. "Records" means any written or recorded information, regardless of physical form or characteristics, which is produced or acquired by the Contractor in the performance of this agreement. Records produced or acquired in a machine readable electronic format shall be maintained in that format. Contractor shall permit the Lead State Contract Administrator, a Participating Entity, a Purchasing Entity, the federal government (including its grant awarding entities and the U.S. Comptroller General), and any other duly authorized agent of a governmental agency, to audit, inspect, examine, copy and/or transcribe Contractor's books, documents, papers and records directly

pertinent to this Master Agreement or orders placed by a Purchasing Entity under it for the purpose of making audits, examinations, excerpts, and transcriptions. This right shall survive for a period of five (5) years following termination of this Agreement or final payment for any order placed by a Purchasing Entity against this Agreement, whichever is later, to assure compliance with the terms hereof or to evaluate performance hereunder.

b. Without limiting any other remedy available to any governmental entity, the Contractor shall reimburse the applicable Lead State, Participating Entity, or Purchasing Entity for any overpayments inconsistent with the terms of the Master Agreement or orders or underpayment of fees found as a result of the examination of the Contractor's records.

c. The rights and obligations herein right exist in addition to any quality assurance obligation in the Master Agreement requiring the Contractor to self-audit contract obligations and that permits the Lead State Contract Administrator to review compliance with those obligations.

22. Administrative Fees

a. The Contractor shall pay to NASPO ValuePoint, or its assignee, a NASPO ValuePoint Administrative Fee of one-quarter of one percent (0.25% or 0.0025) no later than 60 days following the end of each calendar quarter. The NASPO ValuePoint Administrative Fee shall be submitted quarterly and is based on sales of products and services (less any charges for taxes or shipping). The NASPO ValuePoint Administrative Fee is not negotiable. This fee is to be included as part of the pricing submitted with proposal.

b. Additionally, some states may require an additional fee be paid directly to the state on purchases made by Purchasing Entities within that state. For all such requests, the fee level, payment method and schedule for such reports and payments will be incorporated into the Participating Addendum that is made a part of the Master Agreement. The Contractor may adjust the Master Agreement pricing accordingly for purchases made by Purchasing Entities within the jurisdiction of the state. All such agreements shall not affect the NASPO ValuePoint Administrative Fee or the prices paid by the Purchasing Entities outside the jurisdiction of the state requesting the additional fee. The NASPO ValuePoint Administrative Fee in subsection 22a shall be based on the gross amount of all sales (less any charges for taxes or shipping) at the adjusted prices (if any) in Participating Addenda.

23. NASPO ValuePoint Summary and Detailed Usage Reports

In addition to other reports that may be required by this solicitation, the Contractor shall provide the following NASPO ValuePoint reports.

a. Summary Sales Data. The Contractor shall submit quarterly sales reports directly to NASPO ValuePoint using the NASPO ValuePoint Quarterly Sales/Administrative Fee Reporting Tool found at <http://www.naspo.org/WNCPO/Calculator.aspx>. Any/all sales made under the contract shall be reported as cumulative totals by state. Even if Contractor experiences zero sales during a calendar quarter, a report is still required. Reports shall be due no later than 30 day following the end of the calendar quarter (as specified in the reporting tool).

b. Detailed Sales Data. Contract Vendor shall also report detailed sales data by: (1) state; (2) entity/customer type, e.g. local government, higher education, K12, non-profit; (3) Purchasing Entity name; (4) Purchasing Entity bill-to and ship-to locations; (4) Purchasing Entity and Contract Vendor Purchase Order identifier/number(s); (5) Purchase Order Type (e.g. sales order, credit, return, upgrade, determined by industry practices); (6) Purchase Order date; (7) Ship Date; (8) and line item description, including product number if used. The report shall be submitted in any form required by the solicitation. Reports are due on a quarterly basis and must be received by the Lead State and NASPO ValuePoint Cooperative Development Team no later than thirty (30) days after the end of the reporting period. Reports shall be delivered to the Lead State and to the NASPO ValuePoint Cooperative Development Team electronically through a designated portal, email, CD-ROM, flash drive or other method as determined by the Lead State. Detailed sales data reports shall include sales information for all sales under Participating Addenda executed under this Master Agreement.

c. Reportable sales for the summary sales data report and detailed sales data report includes sales to employees for personal use where authorized by the solicitation.

d. Timely submission of these reports is a material requirement of the Master Agreement. The recipient of the reports shall have exclusive ownership of the media containing the reports. The Lead State and NASPO ValuePoint shall have a perpetual, irrevocable, non-exclusive, royalty free, transferable right to display, modify, copy, and otherwise use reports, data and information provided under this section.

24. Standard of Performance and Acceptance.

Any standard of performance under this Master Agreement applies to all Products purchased under this Master Agreement, including any additional, replacement, or substitute Product(s) and any Product(s) which are modified by or with the written approval of Contractor after Acceptance by the Purchasing Entity. The Acceptance Testing period shall be thirty (30)

calendar days or other time period identified in the solicitation or the Participating Addendum, starting from the day after the Product is delivered or, if installed, the day after the Product is installed and Contractor certifies that the Product is ready for Acceptance Testing. If the Product does not meet the standard of performance during the initial period of Acceptance Testing, Purchasing Entity may, at its discretion, continue Acceptance Testing on a day-to-day basis until the standard of performance is met. Upon rejection, the Contractor will have fifteen (15) calendar days to cure the standard of performance issue(s). If after the cure period, the Product still has not met the standard of performance, the Purchasing Entity may, at its option: (a) declare Contractor to be in breach and terminate the Order; (b) demand replacement Product from Contractor at no additional cost to Purchasing Entity; or, (c) continue the cure period for an additional time period agreed upon by the Purchasing Entity and the Contractor. Contractor shall pay all costs related to the preparation and shipping of Product returned pursuant to the section. No Product shall be accepted and no charges shall be paid until the standard of performance is met. The warranty period will begin upon Acceptance.

25. Warranty

The Contractor warrants for a period of one year from the date of Acceptance that: (a) the Product performs according to all specific claims that the Contractor made in its response to the solicitation, (b) the Product is suitable for the ordinary purposes for which such Product is used, (c) the Product is suitable for any special purposes identified in the solicitation or for which the Purchasing Entity has relied on the Contractor's skill or judgment, (d) the Product is designed and manufactured in a commercially reasonable manner, and (e) the Product is free of defects. Upon breach of the warranty, the Contractor will repair or replace (at no charge to the Purchasing Entity) the Product whose nonconformance is discovered and made known to the Contractor. If the repaired and/or replaced Product proves to be inadequate, or fails of its essential purpose, the Contractor will refund the full amount of any payments that have been made. The rights and remedies of the parties under this warranty are in addition to any other rights and remedies of the parties provided by law or equity, including, without limitation, actual damages, and, as applicable and awarded under the law, to a prevailing party, reasonable attorneys' fees and costs.

26. System Failure or Damage

In the event of system failure or damage caused by the Contractor or its Product, the Contractor agrees to use its best efforts to restore or assist in restoring the system to operational capacity.

27. Title of Product

Upon Acceptance by the Purchasing Entity, Contractor shall convey to Purchasing Entity title to the Product free and clear of all liens, encumbrances, or other security interests. Transfer of title to the Product shall include an irrevocable and perpetual license to use any Embedded Software in the Product. If Purchasing Entity subsequently transfers title of the Product to another entity,

Purchasing Entity shall have the right to transfer the license to use the Embedded Software with the transfer of Product title. A subsequent transfer of this software license shall be at no additional cost or charge to either Purchasing Entity or Purchasing Entity's transferee.

28. Waiver of Breach

Failure of the Lead State Contract Administrator, Participating Entity, or Purchasing Entity to declare a default or enforce any rights and remedies shall not operate as a waiver under this Master Agreement or Participating Addendum. Any waiver by the Lead State Contract Administrator, Participating Entity, or Purchasing Entity must be in writing. Waiver by the Lead State Contract Administrator or Participating Entity of any default, right or remedy under this Master Agreement or Participating Addendum, or by Purchasing Entity with respect to any Purchase Order, or breach of any terms or requirements of this Master Agreement, a Participating Addendum, or Purchase Order shall not be construed or operate as a waiver of any subsequent default or breach of such term or requirement, or of any other term or requirement under this Master Agreement, Participating Addendum, or Purchase Order.

29. Assignment of Antitrust Rights

Contractor irrevocably assigns to a Participating Entity any claim for relief or cause of action which the Contractor now has or which may accrue to the Contractor in the future by reason of any violation of state or federal antitrust laws (15 U.S.C. § 1-15 or a Participating Entity's state antitrust provisions), as now in effect and as may be amended from time to time, in connection with any goods or services provided to the Contractor for the purpose of carrying out the Contractor's obligations under this Master Agreement or Participating Addendum, including, at a Participating Entity's option, the right to control any such litigation on such claim for relief or cause of action.

30. Debarment

The Contractor certifies that neither it nor its principals are presently debarred, suspended, proposed for debarment, declared ineligible, or voluntarily excluded from participation in this transaction (contract) by any governmental department or agency. This certification represents a recurring certification made at the time any Order is placed under this Master Agreement. If the Contractor cannot certify this statement, attach a written explanation for review by the Lead State Contract Administrator.

31. Governing Law and Venue

a. The procurement, evaluation, and award of the Master Agreement shall be governed by and construed in accordance with the laws of the Lead State sponsoring and administering the procurement. The construction and effect of the Master Agreement after award shall be

governed by the law of the state serving as Lead State Contract Administrator (in most cases also the Lead State). The construction and effect of any Participating Addendum or Order against the Master Agreement shall be governed by and construed in accordance with the laws of the Participating Entity's or Purchasing Entity's State.

b. Unless otherwise specified, the venue for any protest, claim, dispute or action relating to the procurement, evaluation, and award is in the Lead State. Venue for any claim, dispute or action concerning the terms of the Master Agreement shall be in the state serving as Lead State Contract Administrator. Venue for any claim, dispute, or action concerning any Order placed against the Master Agreement or the effect of a Participating Addendum shall be in the Purchasing Entity's State.

c. Subject to all immunities, defenses, rights or actions arising out of the Lead State's, or any Participation Entity's or Purchasing Entity's, sovereign status or under the Eleventh Amendment to the United States Constitution, if a claim is brought in a federal forum with jurisdiction, then it must be brought and adjudicated solely and exclusively within the United States District Court for (in decreasing order of priority): the Lead State for claims relating to the procurement, evaluation, award, or contract performance or administration if the Lead State is a party; the Participating Entity if a named party; or the Purchasing Entity if a named party. No waiver of any of the aforementioned immunities, defenses, rights or actions shall be implied or otherwise deemed to exist by reason of the Lead State's, or any Participation Entity's or Purchasing Entity's, entry into this Contract.

32. DEFINITIONS

The following definitions apply to this solicitation contract.

Acceptance means a written notice from a Purchasing Entity to Contractor advising Contractor that the Product has passed its Acceptance Testing. Acceptance of a Product for which acceptance testing is not required shall occur following the completion of delivery, installation, if required, and a reasonable time for inspection of the Product, unless the Purchasing Entity provides a written notice of rejection to Contractor.

Acceptance Testing means the process for ascertaining that the Product meets the standards set forth in the section titled Standard of Performance and Acceptance, prior to Acceptance by the Purchasing Entity.

Contractor means the person or entity delivering Products or performing services under the terms and conditions set forth in this Master Agreement.

Embedded Software means one or more software applications which permanently reside on a computing device.

Intellectual Property means any and all patents, copyrights, service marks, trademarks, trade secrets, trade names, patentable inventions, or other similar proprietary rights, in tangible or intangible form, and all rights, title, and interest therein.

Lead State Contract Administrator means the State centrally administering the Master Agreement after execution with the permission of the NASPO ValuePoint States. The Lead State Administrator normally is the same as the Lead State conducting the cooperative procurement, evaluation, and award.

Master Agreement means the underlying agreement executed by and between the NASPO ValuePoint contract administrator, normally the Lead State, acting on behalf of NASPO ValuePoint, and the Contractor, as now or hereafter amended.

Order or Purchase Order means any purchase order, sales order, contract or other document used by a Purchasing Entity to order the Products.

Participating Addendum means a bilateral agreement executed by a Contractor and a Participating Entity incorporating this Master Agreement and any other additional Participating Entity specific language or other requirements, e.g. ordering procedures specific to the Participating Entity, other terms and conditions.

Participating Entity means a state, or other legal entity, properly authorized to enter into a Participating Addendum.

Participating State means a state, the District of Columbia, or one of the territories of the United States that is listed in this Request for Proposal as intending to participate. A Participating State is required to participate through execution of a Participating Addendum. Upon execution of the Participating Addendum, a Participating State becomes a Participating Entity.

Product means any equipment, software (including embedded software), documentation, service or other deliverable supplied or created by the Contractor pursuant to this Master Agreement. The term Products, supplies and services, and products and services are used interchangeably in these terms and conditions.

Purchasing Entity means a state, city, county, district, other political subdivision of a State, and a nonprofit organization under the laws of some states if authorized by a Participating Addendum, who issues a Purchase Order against the Master Agreement and becomes financially committed to the purchase.

NASPO ValuePoint is the NASPO Cooperative Purchasing Program, LLC, doing business as NASPO ValuePoint, , a 501(c)(3) limited liability company that is a subsidiary organization the National Association of State Procurement Officials (NASPO), the sole member of NASPO ValuePoint. NASPO ValuePoint facilitates administration of the cooperative group contracting consortium of state chief procurement officials for the benefit of state departments, institutions, agencies, and political subdivisions and other eligible entities (i.e., colleges, school districts, counties, cities, some nonprofit organizations, etc.) for all states and the District of Columbia. The NASPO ValuePoint Cooperative Development Team is identified in the Master Agreement as the recipient of reports and may be performing contract administration functions relating to collecting and receiving reports as well as other contract administration functions as assigned by the Lead State Contract Administrator.

33. NASPO ValuePoint eMarket Center

a. In July 2011, NASPO ValuePoint entered into a multi-year agreement with SciQuest, Inc. whereby SciQuest will provide certain electronic catalog hosting and management services to enable eligible NASPO ValuePoint entity's customers to access a central online website to view and/or shop the goods and services available from existing NASPO ValuePoint Cooperative Contracts. The central online website is referred to as the NASPO ValuePoint eMarket Center Contractor shall either upload a hosted catalog into the eMarket Center or integrate a punchout site with the eMarket Center.

b. Supplier's Interface with the eMarket Center. There is no cost charged by SciQuest to the Contractor for loading a hosted catalog or integrating a punchout site.

c. At a minimum, the Contractor agrees to the following:

(1) Implementation Timeline: NASPO ValuePoint eMarket Center Site Admin shall provide a written request to the Contractor to begin enablement process. The Contractor shall have fifteen (15) days from receipt of written request to work with NASPO ValuePoint and SciQuest to set up an enablement schedule, at which time SciQuest's technical documentation shall be provided to the Contractor. The schedule will include future calls and milestone dates related to test and go live dates. The contractor shall have a total of Ninety (90) days to deliver either a (1) hosted catalog or (2) punch-out catalog, from date of receipt of written request.

(2) NASPO ValuePoint and SciQuest will work with the Contractor, to decide which of the catalog structures (either hosted or punch-out as further described below) shall be provided by the Contractor. **Whether hosted or punch-out, the catalog must be strictly limited to the Contractor's awarded contract offering (e.g. products and/or services not authorized through the resulting cooperative contract should not be viewable by NASPO ValuePoint Participating Entity users).**

(a) Hosted Catalog. By providing a hosted catalog, the Contractor is providing a list of its awarded products/services and pricing in an electronic data file in a format acceptable to SciQuest, such as Tab Delimited Text files. In this scenario, the Contractor must submit updated electronic data monthly to the eMarket Center for the Lead State

Contract Administrator's approval to maintain the most up-to-date version of its product/service offering under the cooperative contract in the eMarket Center.

(b) Punch-Out Catalog. By providing a punch-out catalog, the Contractor is providing its own online catalog, which must be capable of being integrated with the eMarket Center as a. Standard punch-in via Commerce extensible Markup Language (cXML). In this scenario, the Contractor shall validate that its online catalog is up-to-date by providing a written update on a monthly basis to the Lead State Contract Administrator stating they have audited the offered products/services and pricing listed on its online catalog. The site must also return detailed UNSPSC codes (as outlined in line 3) for each line item. Contractor also agrees to provide e-Quote functionality to facilitate volume discounts.

d. Revising Pricing and Product Offerings: Any revisions (whether an increase or decrease) to pricing or product/service offerings (new products, altered SKUs, etc.) must be pre-approved by the Lead State Contract Administrator and shall be subject to any other applicable restrictions with respect to the frequency or amount of such revisions. However, no cooperative contract enabled in the eMarket Center may include price changes on a more frequent basis than once per quarter. The following conditions apply with respect to hosted catalogs:

(1). Updated pricing files are required by the 1st of the month and shall go into effect in the eMarket Center on the 1st day of the following month (i.e. file received on 1/01/13 would be effective in the eMarket Center on 2/01/13)]. Files received after the 1st of the month may be delayed up to a month (i.e. file received on 11/06/09 would be effect in the eMarket Center on 1/01/10).

(2) Lead State Contract Administrator-approved price changes are not effective until implemented within the eMarket Center. Errors in the Contractor's submitted pricing files will delay the implementation of the price changes in eMarket Center.

e. Supplier Network Requirements: Contractor shall join the SciQuest Supplier Network (SQSN) and shall use the SciQuest's Supplier Portal to import the Contractor's catalog and pricing, into the SciQuest system, and view reports on catalog spend and product/pricing freshness. The Contractor can receive orders through electronic delivery (coml.) or through low-tech options

such as fax. More information about the SQSN can be found at: www.sciquest.com or call the SciQuest Supplier Network Services team at 800-233-1121.

f. Minimum Requirements: Whether the Contractor is providing a hosted catalog or a punch-out catalog, the Contractor agrees to meet the following requirements:

(1) Catalog must contain the most current pricing, including all applicable administrative fees and/or discounts, as well as the most up-to-date product/service offering the Contractor is authorized to provide in accordance with the cooperative contract; and

(2) The accuracy of the catalog must be maintained by Contractor throughout the duration of the cooperative contract between the Contractor and the Contract Administrator; and

(3) The Catalog must include a Lead State contract identification number; and

(4) The Catalog must include detailed product line item descriptions; and

(5) The Catalog must include pictures when possible; and

(6) The Catalog must include any additional NASPO ValuePoint and Participating Addendum requirements. Although suppliers in the SQSN normally submit one (1) catalog, it is possible to have multiple contracts applicable to different NASPO ValuePoint Participating Entities. For example, a supplier may have different pricing for state government agencies and Board of Regents institutions. Suppliers have the ability and responsibility to submit separate contract pricing for the same catalog if applicable. The system will deliver the appropriate contract pricing to the user viewing the catalog.

g. Order Acceptance Requirements: Contractor must be able to accept Purchase Orders via fax or cXML. The Contractor shall provide positive confirmation via phone or email within 24 hours of the Contractor's receipt of the Purchase Order. If the Purchasing Order is received after 3pm

EST on the day before a weekend or holiday, the Contractor must provide positive confirmation via phone or email on the next business day.

h. UNSPSC Requirements: Contractor shall support use of the United Nations Standard Product and Services Code (UNSPSC). UNSPSC versions that must be adhered to are driven by SciQuest for the suppliers and are upgraded every year. NASPO ValuePoint reserves the right to migrate to future versions of the UNSPSC and the Contractor shall be required to support the migration effort. All line items, goods or services provided under the resulting statewide contract must be associated to a UNSPSC code. All line items must be identified at the most detailed UNSPSC level indicated by segment, family, class and commodity. More information about the UNSPSC is available at: <http://www.unspsc.com> and <http://www.unspsc.com/FAQs.asp#howdoesunspscwork>.

i. Applicability: Contractor agrees that NASPO ValuePoint controls which contracts appear in the eMarket Center and that NASPO ValuePoint may elect at any time to remove any supplier's offering from the eMarket Center.

j. The Lead State Contract Administrator reserves the right to approve the pricing on the eMarket Center. This catalog review right is solely for the benefit of the Lead State Contract Administrator and Participating Entities, and the review and approval shall not waive the requirement that products and services be offered at prices (and approved fees) required by the Master Agreement.

k. Several NASPO ValuePoint Participating Entities currently maintain separate SciQuest eMarketplaces, these Participating Entities do enable certain NASPO ValuePoint Cooperative Contracts. In the event one of these entities elects to use this NASPO ValuePoint Cooperative Contract (available through the eMarket Center) but publish to their own eMarketplace, the Contractor agrees to work in good faith with the entity and NASPO ValuePoint to implement the catalog. NASPO ValuePoint does not anticipate that this will require substantial additional efforts by the Contractor; however, the supplier agrees to take commercially reasonable efforts to enable such separate SciQuest catalogs.

ATTACHMENT B: PAYMENT PROVISIONS

Contract Sum: The State shall pay Contractor compensation as follows:

1. All prices and rates must be guaranteed for a one year period. Following the initial Master Agreement period, any request for price or rate adjustment must be for an equal guarantee period, and must be made at least sixty (60) days prior to the effective date. Requests for price or rate adjustment must include sufficient documentation supporting the request. Any adjustment or amendment to the Master Agreement shall not be effective unless approved by the Lead State Contract Administrator. No retroactive adjustments to prices or rates will be allowed.
2. The State shall not be responsible for any unauthorized expenses or services incurred and/or performed by Contractor.
3. Contractor shall submit invoicing to the ordering institution or agency and shall specify the address to which payments will be sent and shall include:
 - A numbered invoice.
 - Contract number that the invoice is to be paid from;
4. This agreement represents the entire agreement between the parties; No changes, modifications, or amendments in the terms and conditions of this contract shall be effective unless reduced to writing, numbered and signed by the duly authorized representative of the State and Contractor.
5. The State shall not pay for any unauthorized labor, materials, equipment or expenses of Contractor.
6. Any products or services outside of this agreement shall not be allowed.
7. Payment Terms: Net 30. The State has 30 days from the date the state receives an invoice **with full and complete supporting documentation** to exercise its right to bill or credit adjustments made necessary by internal audits and quality assurance checks.

ATTACHMENT C: STANDARD STATE PROVISIONS FOR CONTRACTS AND GRANTS

1. **Entire Agreement:** This Agreement, whether in the form of a Contract, State Funded Grant, or Federally Funded Grant, represents the entire agreement between the parties on the subject matter. All prior agreements, representations, statements, negotiations, and understandings shall have no effect.
2. **Applicable Law:** This Agreement will be governed by the laws of the State of Vermont.
3. **Definitions:** For purposes of this Attachment, "Party" shall mean the Contractor, Grantee or Subrecipient, with whom the State of Vermont is executing this Agreement and consistent with the form of the Agreement.
4. **Appropriations:** If this Agreement extends into more than one fiscal year of the State (July 1 to June 30), and if appropriations are insufficient to support this Agreement, the State may cancel at the end of the fiscal year, or otherwise upon the expiration of existing appropriation authority. In the case that this Agreement is a Grant that is funded in whole or in part by federal funds, and in the event federal funds become unavailable or reduced, the State may suspend or cancel this Grant immediately, and the State shall have no obligation to pay Subrecipient from State revenues.
5. **No Employee Benefits For Party:** The Party understands that the State will not provide any individual retirement benefits, group life insurance, group health and dental insurance, vacation or sick leave, workers compensation or other benefits or services available to State employees, nor will the state withhold any state or federal taxes except as required under applicable tax laws, which shall be determined in advance of execution of the Agreement. The Party understands that all tax returns required by the Internal Revenue Code and the State of Vermont, including but not limited to income, withholding, sales and use, and rooms and meals, must be filed by the Party, and information as to Agreement income will be provided by the State of Vermont to the Internal Revenue Service and the Vermont Department of Taxes.
6. **Independence, Liability:** The Party will act in an independent capacity and not as officers or employees of the State.

The Party shall defend the State and its officers and employees against all claims or suits arising in whole or in part from any act or omission of the Party or of any agent of the Party. The State shall notify the Party in the event of any such claim or suit, and the Party shall immediately retain counsel and otherwise provide a complete defense against the entire claim or suit.

After a final judgment or settlement the Party may request recoupment of specific defense costs and may file suit in Washington Superior Court requesting recoupment. The Party shall be entitled to recoup costs only upon a showing that such costs were entirely unrelated to the defense of any claim arising from an act or omission of the Party.

The Party shall indemnify the State and its officers and employees in the event that the State, its officers or employees become legally obligated to pay any damages or losses arising from any act or omission of the Party.

7. **Insurance:** Before commencing work on this Agreement the Party must provide certificates of insurance to show that the following minimum coverages are in effect. It is the responsibility of the Party to maintain current certificates of insurance on file with the state through the term of the Agreement. No warranty is made that the coverages and limits listed

herein are adequate to cover and protect the interests of the Party for the Party's operations. These are solely minimums that have been established to protect the interests of the State.

Workers Compensation: With respect to all operations performed, the Party shall carry workers' compensation insurance in accordance with the laws of the State of Vermont.

General Liability and Property Damage: With respect to all operations performed under the contract, the Party shall carry general liability insurance having all major divisions of coverage including, but not limited to:

Premises - Operations
Products and Completed Operations
Personal Injury Liability
Contractual Liability

The policy shall be on an occurrence form and limits shall not be less than:

\$1,000,000 Per Occurrence
\$1,000,000 General Aggregate
\$1,000,000 Products/Completed Operations Aggregate
\$ 50,000 Fire/ Legal/Liability

Party shall name the State of Vermont and its officers and employees as additional insureds for liability arising out of this Agreement.

Automotive Liability: The Party shall carry automotive liability insurance covering all motor vehicles, including hired and non-owned coverage, used in connection with the Agreement. Limits of coverage shall not be less than: \$1,000,000 combined single limit.

Party shall name the State of Vermont and its officers and employees as additional insureds for liability arising out of this Agreement.

8. **Reliance by the State on Representations:** All payments by the State under this Agreement will be made in reliance upon the accuracy of all prior representations by the Party, including but not limited to bills, invoices, progress reports and other proofs of work.
9. **Requirement to Have a Single Audit:** In the case that this Agreement is a Grant that is funded in whole or in part by federal funds, the Subrecipient will complete the Subrecipient Annual Report annually within 45 days after its fiscal year end, informing the State of Vermont whether or not a Single Audit is required for the prior fiscal year. If a Single Audit is required, the Subrecipient will submit a copy of the audit report to the granting Party within 9 months. If a single audit is not required, only the Subrecipient Annual Report is required.

For fiscal years ending before December 25, 2015, a Single Audit is required if the subrecipient expends \$500,000 or more in federal assistance during its fiscal year and must be conducted in accordance with OMB Circular A-133. For fiscal years ending on or after December 25, 2015, a Single Audit is required if the subrecipient expends \$750,000 or more in federal assistance during its fiscal year and must be conducted in accordance with 2 CFR Chapter I, Chapter II, Part 200, Subpart F. The Subrecipient Annual Report is required to be submitted within 45 days, whether or not a Single Audit is required.

10. **Records Available for Audit:** The Party shall maintain all records pertaining to performance under this agreement. "Records" means any written or recorded information, regardless of physical form or characteristics, which is produced or acquired by the Party in

the performance of this agreement. Records produced or acquired in a machine readable electronic format shall be maintained in that format. The records described shall be made available at reasonable times during the period of the Agreement and for three years thereafter or for any period required by law for inspection by any authorized representatives of the State or Federal Government. If any litigation, claim, or audit is started before the expiration of the three year period, the records shall be retained until all litigation, claims or audit findings involving the records have been resolved.

11. Fair Employment Practices and Americans with Disabilities Act: Party agrees to comply with the requirement of Title 21V.S.A. Chapter 5, Subchapter 6, relating to fair employment practices, to the full extent applicable. Party shall also ensure, to the full extent required by the Americans with Disabilities Act of 1990, as amended, that qualified individuals with disabilities receive equitable access to the services, programs, and activities provided by the Party under this Agreement. Party further agrees to include this provision in all subcontracts.

12. Set Off: The State may set off any sums which the Party owes the State against any sums due the Party under this Agreement; provided, however, that any set off of amounts due the State of Vermont as taxes shall be in accordance with the procedures more specifically provided hereinafter.

13. Taxes Due to the State:

- a. Party understands and acknowledges responsibility, if applicable, for compliance with State tax laws, including income tax withholding for employees performing services within the State, payment of use tax on property used within the State, corporate and/or personal income tax on income earned within the State.
- b. Party certifies under the pains and penalties of perjury that, as of the date the Agreement is signed, the Party is in good standing with respect to, or in full compliance with, a plan to pay any and all taxes due the State of Vermont.
- c. Party understands that final payment under this Agreement may be withheld if the Commissioner of Taxes determines that the Party is not in good standing with respect to or in full compliance with a plan to pay any and all taxes due to the State of Vermont.
- d. Party also understands the State may set off taxes (and related penalties, interest and fees) due to the State of Vermont, but only if the Party has failed to make an appeal within the time allowed by law, or an appeal has been taken and finally determined and the Party has no further legal recourse to contest the amounts due.

14. Child Support: (Applicable if the Party is a natural person, not a corporation or partnership.) Party states that, as of the date the Agreement is signed, he/she:

- a. is not under any obligation to pay child support; or
- b. is under such an obligation and is in good standing with respect to that obligation; or
- c. has agreed to a payment plan with the Vermont Office of Child Support Services and is in full compliance with that plan.

Party makes this statement with regard to support owed to any and all children residing in Vermont. In addition, if the Party is a resident of Vermont, Party makes this statement with regard to support owed to any and all children residing in any other state or territory of the United States.

15. Sub-Agreements: Party shall not assign, subcontract or subgrant the performance of this Agreement or any portion thereof to any other Party without the prior written approval of the State. Party also agrees to include in all subcontract or subgrant agreements a tax certification in accordance with paragraph 13 above.

16. No Gifts or Gratuities: Party shall not give title or possession of any thing of substantial value (including property, currency, travel and/or education programs) to any officer or employee of the State during the term of this Agreement.

17. Copies: All written reports prepared under this Agreement will be printed using both sides of the paper.

18. Certification Regarding Debarment: Party certifies under pains and penalties of perjury that, as of the date that this Agreement is signed, neither Party nor Party's principals (officers, directors, owners, or partners) are presently debarred, suspended, proposed for debarment, declared ineligible or excluded from participation in federal programs, or programs supported in whole or in part by federal funds.

Party further certifies under pains and penalties of perjury that, as of the date that this Agreement is signed, Party is not presently debarred, suspended, nor named on the State's debarment list at: <http://bgs.vermont.gov/purchasing/debarment>

19. Certification Regarding Use of State Funds: In the case that Party is an employer and this Agreement is a State Funded Grant in excess of \$1,001, Party certifies that none of these State funds will be used to interfere with or restrain the exercise of Party's employee's rights with respect to unionization.

20. Internal Controls: In the case that this Agreement is an award that is funded in whole or in part by Federal funds, in accordance with 2 CFR Part II, §200.303, the Party must establish and maintain effective internal control over the Federal award to provide reasonable assurance that the Party is managing the Federal award in compliance with Federal statutes, regulations, and the terms and conditions of the award. These internal controls should be in compliance with guidance in "Standards for Internal Control in the Federal Government" issued by the Comptroller General of the United States and the "Internal Control Integrated Framework", issued by the Committee of Sponsoring Organizations of the Treadway Commission (COSO).

21. Mandatory Disclosures: In the case that this Agreement is an award funded in whole or in part by Federal funds, in accordance with 2CFR Part II, §200.113, Party must disclose, in a timely manner, in writing to the State, all violations of Federal criminal law involving fraud, bribery, or gratuity violations potentially affecting the Federal award. Failure to make required disclosures may result in the imposition of sanctions which may include disallowance of costs incurred, withholding of payments, termination of the Agreement, suspension/debarment, etc.

22. Conflict of Interest: Party must disclose in writing any potential conflict of interest in accordance with Uniform Guidance §200.112, Bulletin 5 Section IX and Bulletin 3.5 Section IV.B.

(End of Standard Provisions)

**SNOW PLOW BLADE CUTTING EDGES
DETAILED SPECIFICATIONS
VERMONT**

General: It is the purpose and intent of these specifications to describe a high quality snow plow blade cutting edges. The blades will be constructed as shown in the enclosed diagrams. Blade sections will be identified by use of the part number being stamped on the end or stenciled on the face of the blade section. Shipments may be refused if blades are not labeled. The finished blade section will be given one coat of rust resistant lacquer. Blade sections will be bundled with like blades when shipped, do not mix blades in bundles. Shipping papers and invoices are to include the part number.

REGULAR STEEL SNOW PLOW BLADE CUTTING EDGES

1. Blade:

- A. The blade will be 5/8" thick unless otherwise specified AISI C1090 quality steel.
- B. Punched or drilled square bolt holes will be 11/16" diameter. The location and spacing of the holes will be as designated on the diagrams provided.
- C. The center of the holes shall be in line within 1/32" of the established center line.

HARDENED SNOW PLOW BLADE CUTTING EDGES

1. Blade:

- A. The blade will be 1" thick AISI 1074 quality steel.
- B. Punched or drilled square bolt holes will be 11/16" diameter. The location and spacing of the holes will be as designated on the diagrams provided.
- C. The center of the holes shall be in line within 1/32" of the established centerline.

2. Hardness:

- A. Blades will be selectively hardened front and back a primary and secondary hardness.
- B. The hardening pattern will start 5/8" +/- 1/8" above the bottom edge of the blade with a 3 1/2" width over the length of the blade.
- C. Primary hardness, Rockwell C 62 +/- 5, for a depth of 1/8" +/- 1/32" at the high point of the pattern.
- D. Secondary hardness, Rockwell C 50 +/- 5, for a minimum depth of 1/32" at the high point of the pattern.

TUNGSTEN CARBIDE TIPPED SNOW PLOW BLADE CUTTING EDGES

Tungsten Carbide Tipped: A "Type A" certification will be provided on the carbide insert by the manufacturer to include:

Percent Cobalt
Density in GMSLCC
Hardness (Rockwell A)
Transverse Rupture Strength in PSI Statement certifying that no reclaimed or scrap tungsten carbide has been used.

1. **Blade:**
 - A. The blade will be 3/4" thick flat hot rolled finished SAE 1020 steel.
 - B. Punching will be 11/16" square holes countersunk for 5/8" diameter
Plow bolts. The location and spacing of the holes will be as designated on the diagrams provided.
 - C. The center of the holes shall be in line within 1/32" of the established centerline.
 - D. The groove for the carbide inserts will be milled in the center of the blade edge.
 - E. The highest and lowest tip points are not to exceed 1/32" in a multiple blade set.
 - F. Blades will be free of warp age
 - G. Longitudinal deviation will not exceed 1/8" on a 6' section.

2. **Tungsten Carbide Inserts:**
 - A. The inserts will be high shock WC grade virgin tungsten carbide with a cobalt content not less than 11.5% or more than 12.5%.
Hardness: 87.5 minimum to 88.5 maximum, Rc. "A" Scale.
Density: 14.1 minimum to 14.6 maximum GMSLCC.
Transverse Rupture Strength: 350,000 P.S.I. minimum.
 - B. The inserts will be a trapezoid design conforming to the following dimensions.
Height: .635 +/- .005
Width: .365 +/- .005
Length: 1" Nominal
Bottom Angle: 25 degrees with a nose radius of 1/16" minimum.

3. **Brazing:**

- A. Brazing material will be a high strength silver alloy type. Braze shear strength to be 30,000 P.S.I. minimum.
- B. Tungsten carbide inserts will be positioned in the milled groove with .010" between inserts for the entire length of each blade section.
- C. The inserts will be brazed on all sides using sound brazing practices. There will be no voids or use of shims.

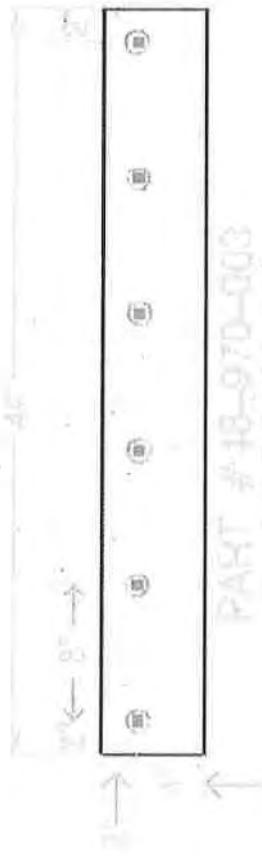

PART # 48-970-003
8 HOLES 8" C/C

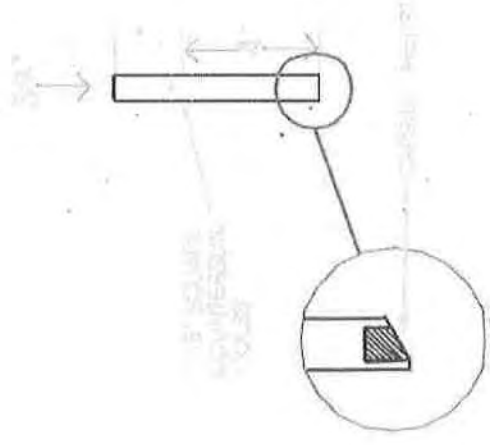

BLADE: CARBIDE STEEL SET
TYPE: PLOW 44" - 6" TP
NUMBER: 48-970-003
DATE: 400



PART #48-970-004
5 HOLES 8" OC

BLADE: CARBIDE STEEL SET
TYPE: PLOW 44" - 6" TP
NUMBER: 48-970-004
DATE: 400

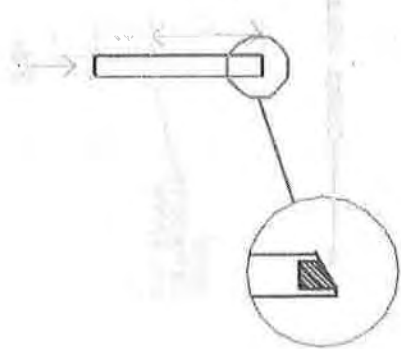



PART: #48-970-005
 3 HOLES 8" CG

BLADE: CARBIDE STEEL SET
 TYPE: PLOW 28" - 6" TP
 NUMBER: 48-970-005
 DATE: 400

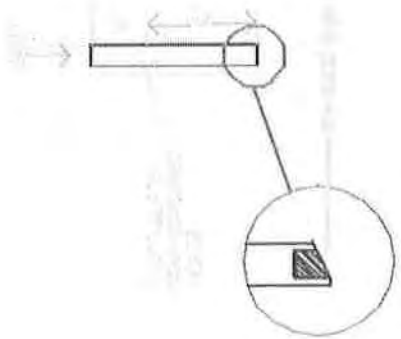



PART # 48-970-008
9 HOLES 9" DO

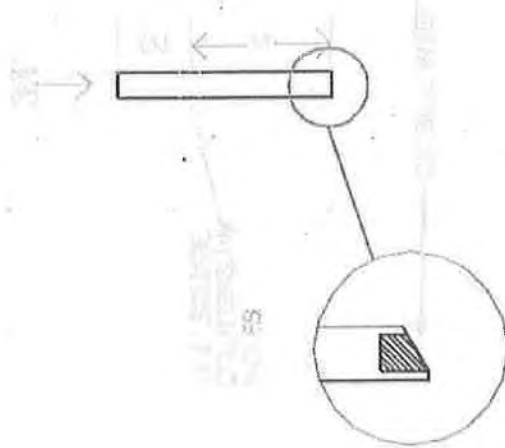

BLADE: CARBIDE STEEL SET
TYPE: PLOW 72" - 6" TP
NUMBER: 48-970-008
DATE: 604

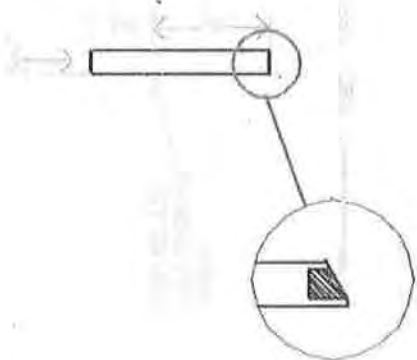
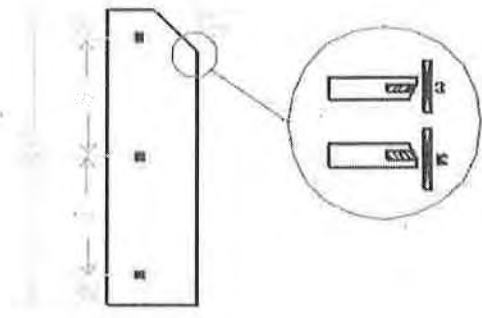

NOTE: Orders will be right-hand (R) or left-hand (L) to designate the direction of the taper on the leading edge

**BLADE: CARBIDE STEEL
 TYPE: WING END SECTION
 NUMBER: 48-970-013
 DATE: 400**

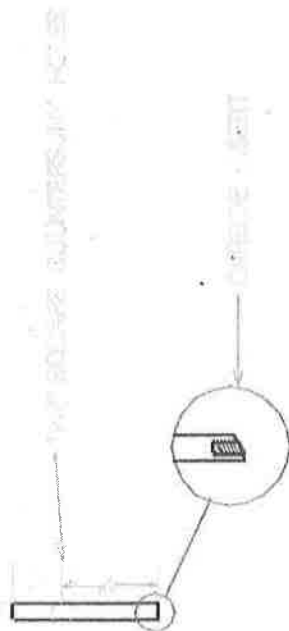

BLADE: CARBIDE STEEL
TYPE: GRADER 121 MOLDBOARD
NUMBER: 48-870-011
DATE: 3/02



PART #48-970-020
5 HOLES

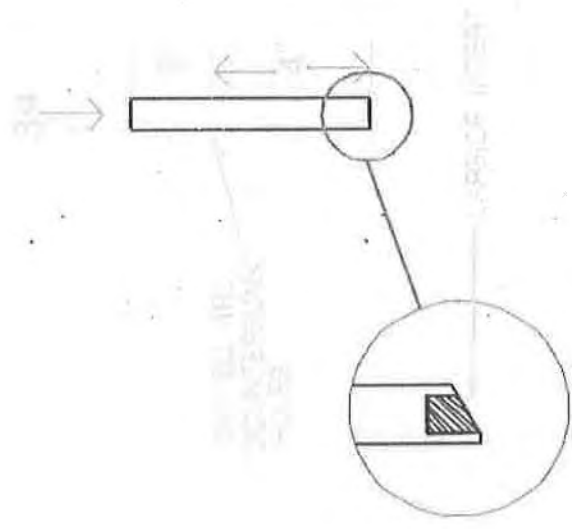

BLADE: CARBIDE STEEL
TYPE: PLOW 36"-6" TP
NUMBER: 48-970-020
DATE: 604

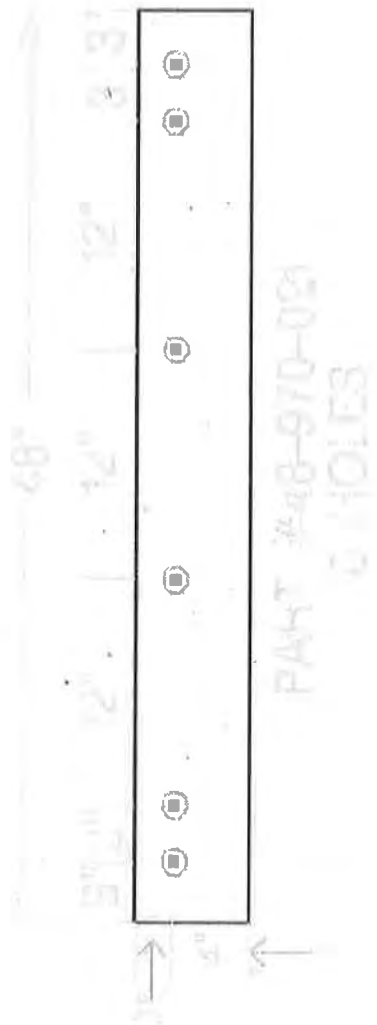

BLADE: CARBIDE STEEL
 TYPE: PLOW 48"-6" TP
 NUMBER: 48-970-021
 DATE: 604

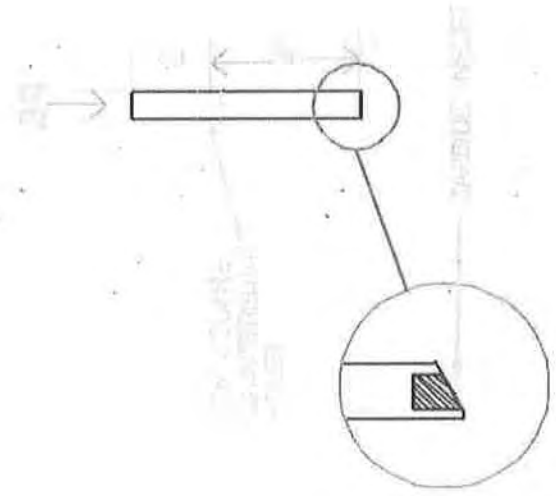

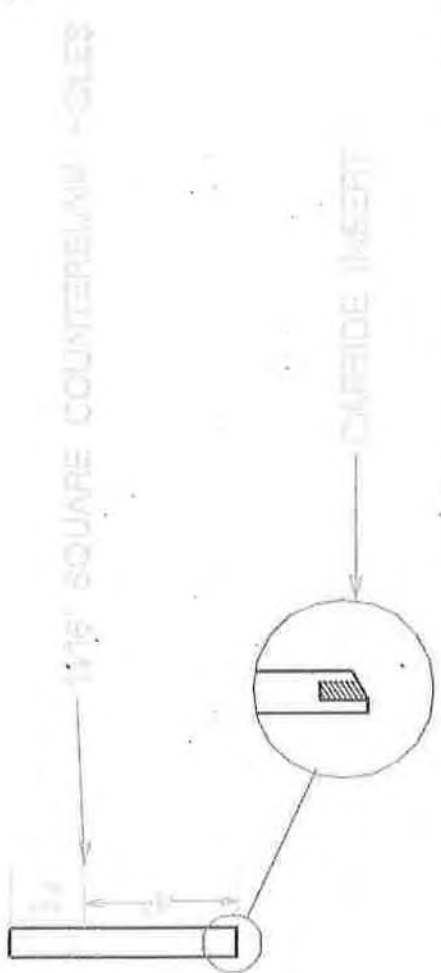

BLADE: CARBIDE STEEL
TYPE: JOHN DEERE MOLDBOARD
NUMBER: 48-970-030
DATE: 604

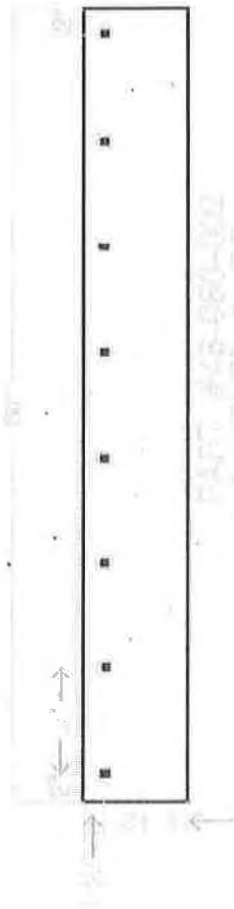

PART #48-960-002
8 HOLES @ 6" OC

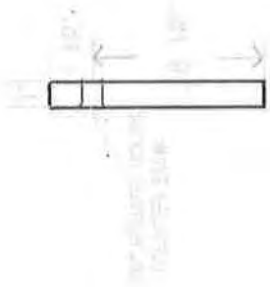

1.0" DIAMETER
1.0" LENGTH

BLADE: HARDENED STEEL SET
TYPE: PLOW 60" - 8" TP
NUMBER: 48-960-002
DATE: 600



PART #48-260-003
 2 HOLES BY GC

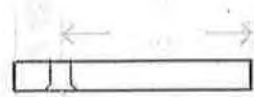

BLADE: HARDENED STEEL SET
TYPE: PLOW 72" - 8" TP
NUMBER: 48-960-003
DATE: 600



PART #48-960-010
7 HOLES



BLADE: HARDENED STEEL SET
TYPE: PLOW 60" - 8" TP
NUMBER: 48-960-010
DATE: 604



7' x 1/2" #48-960-011
8 HOLES

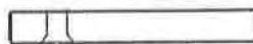

BLADE: HARDENED STEEL SET
TYPE: PLOW 72" - 8" TP
NUMBER: 48-960-011
DATE: 604

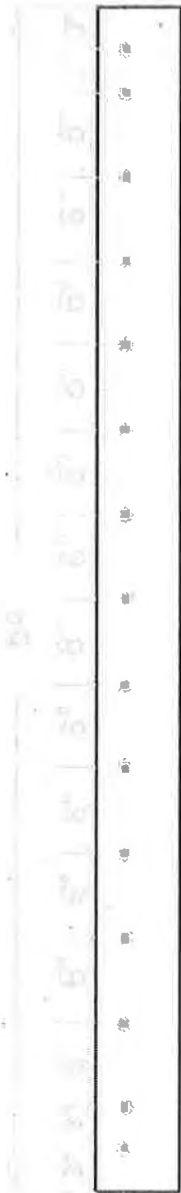

1 1/2" SQUARE COUNTERSINK HOLES

BLADE: HARDENED STEEL
TYPE: JD MOLDBOARD 8" TP
NUMBER: 48-960-030
DATE: 604

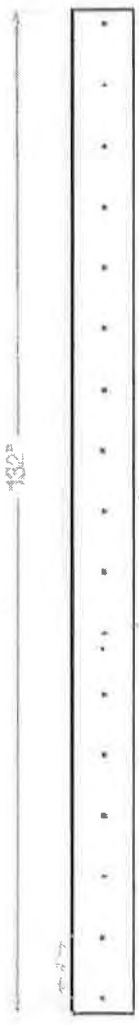

17 SQUARE HOLES @ 8' OC

BLADE: REGULAR STEEL
TYPE: PLOW 11'-8" CP
NUMBER: 46-610-001
DATE: 4/00



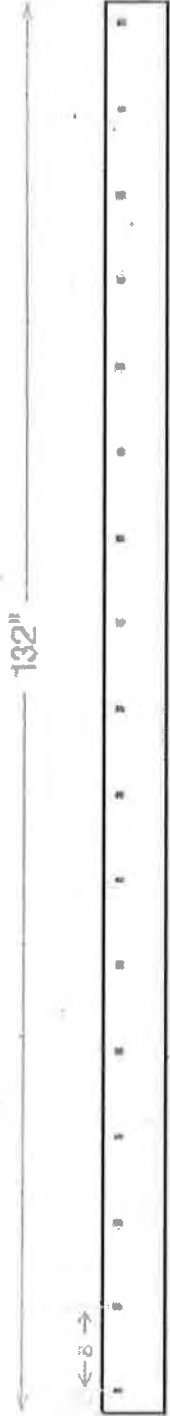

17 SQUARE HOLES 8" C/C

BLADE: REGULAR STEEL
TYPE: PLOW 11'-6" TP
NUMBER: 48-910-002
DATE: 400



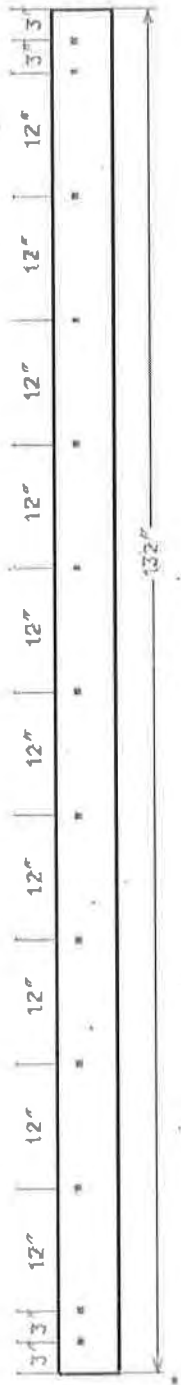

13 SQUARE HOLES 12" C/C

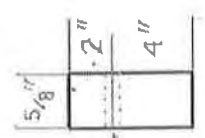

1/16" SQUARE HOLE

BLADE: REGULAR STEEL
 TYPE: PLOW 11' -6"
 NUMBER: 48-910-020
 DATE: 6/04

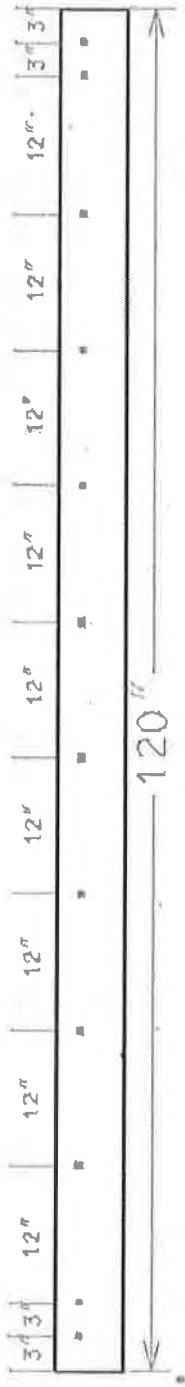

12 SQUARE HOLES 12" C/C



1 1/16" SQUARE HOLE

BLADE: REGULAR STEEL
 TYPE: PLOW 10'-6" TP
 NUMBER: 48-910-021
 DATE: 6/04

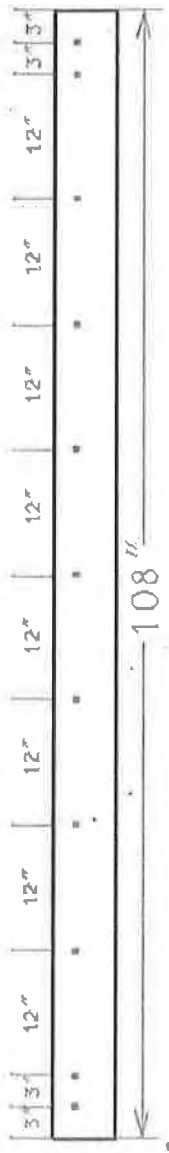

11 SQUARE HOLES 12" C/C

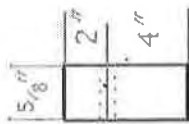

1/16" SQUARE HOLE

BLADE: REGULAR STEEL
 TYPE: PLOW 9'-6"
 NUMBER: 48-910-022
 DATE: 6/04

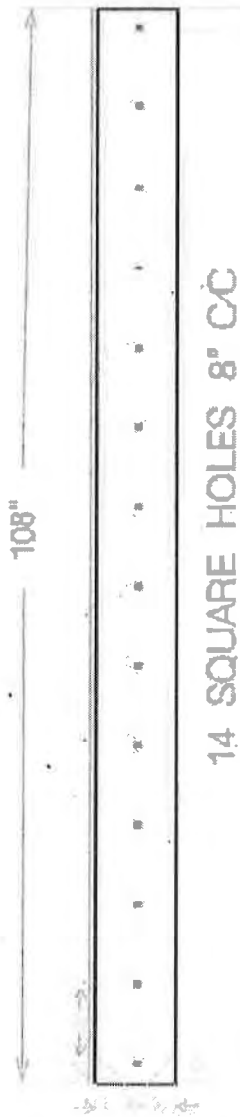

BLADE: REGULAR STEEL
TYPE: WING 8' - 8" CP
NUMBER: 48-820-002
DATE: 302

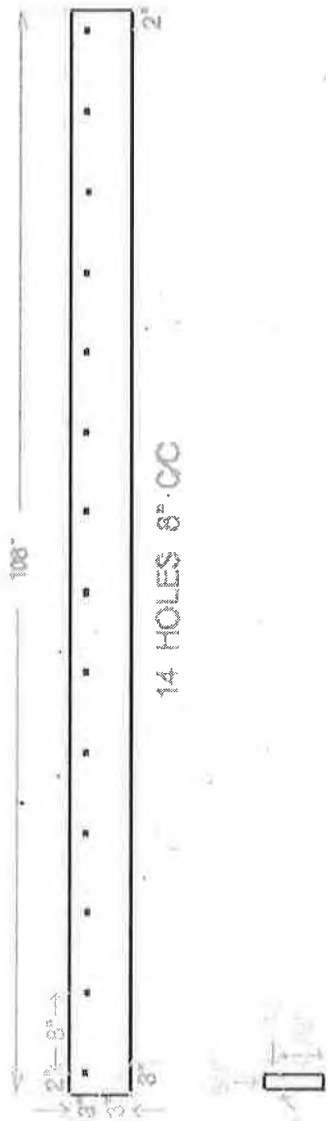

GRADE: REGULAR STEEL
 TYPE: WMS 7 - 8" TP
 NUMBER: 48-800-003
 DATE: 400

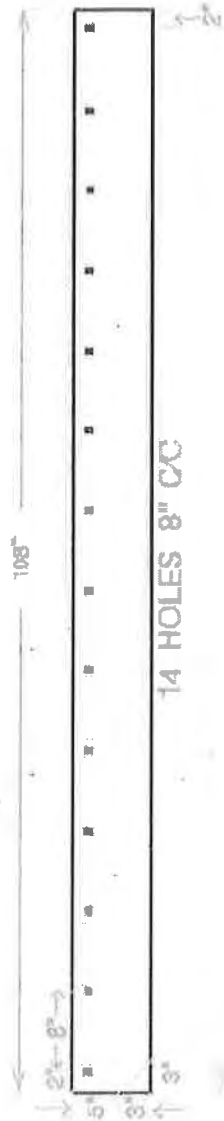

BLADE: REGULAR STEEL
 TYPE: WING 9' - 8" TP
 NUMBER: 48-620-004
 DATE: 400

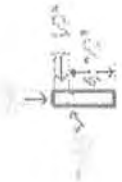

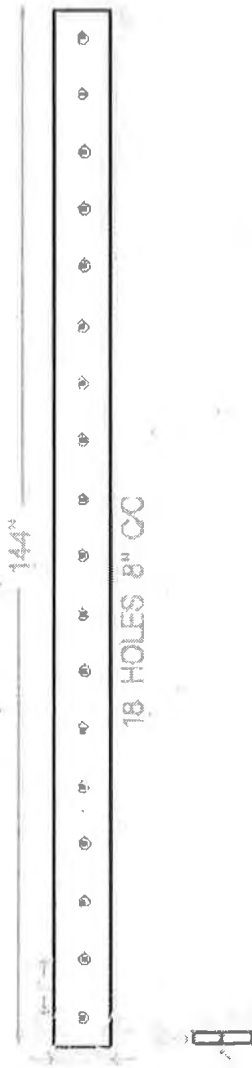

GRADE: REGULAR STEEL
TYPE: GRADER WING 12' - 8" CP
NUMBER: 48-600-005
DATE: 3/02

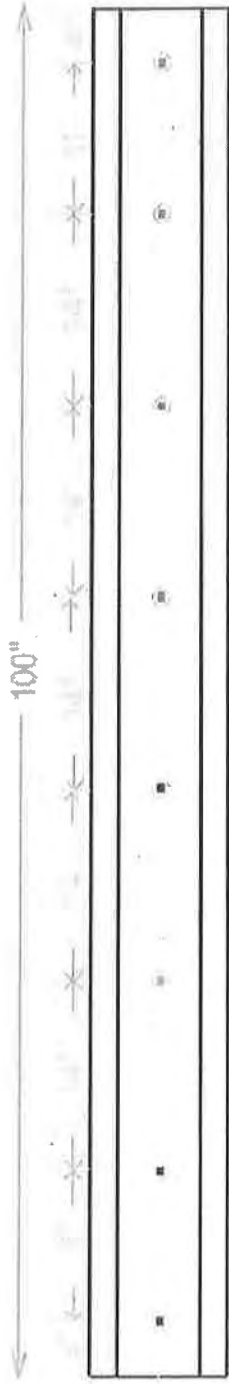

BLADE: REGULAR STEEL
 TYPE: LOADER JD 544E
 NUMBER: 48-940-001
 DATE: 302

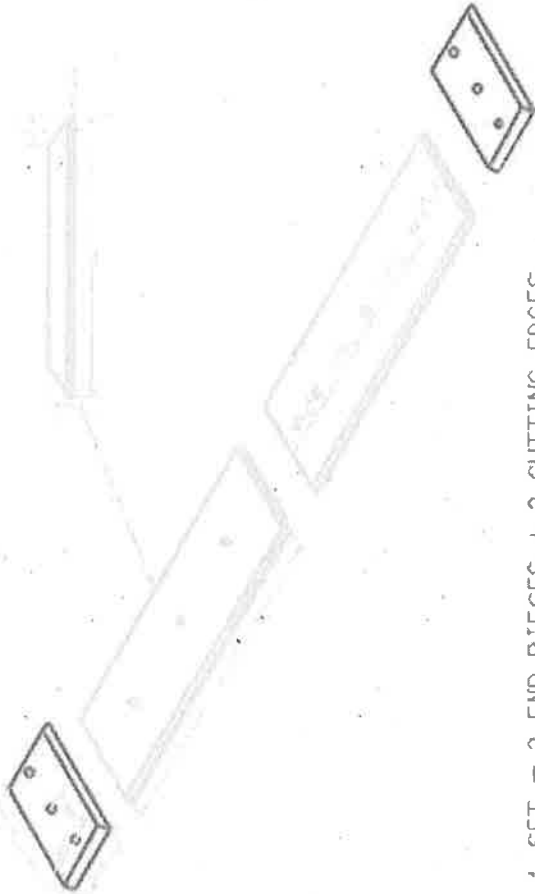

NOTE: 1 SET = 2 END PIECES + 2 CUTTING EDGES

7/8" COUNTERSUNK HOLES



BLADE: REGULAR STEEL
TYPE: LOADER 544G
NUMBER: 48-940-002
DATE: 600



BLADE: REGULAR STEEL
 TYPE: JD 310/410
 NUMBER: 48-940-003
 DATE: 302



8 SQUARE HOLES 12 1/2" CG



**BLADE: REGULAR STEEL
TYPE: PLOW 8' FISHER
NUMBER: 48-940-021
DATE: 604**

side view

1/4"
1 1/8"



11/16" square bolt

Trapezoid insert

365 x ~~365~~ x 1"

635

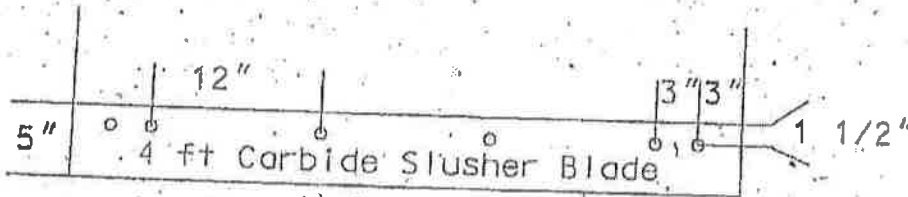

code 62030001005
11/16" square holes

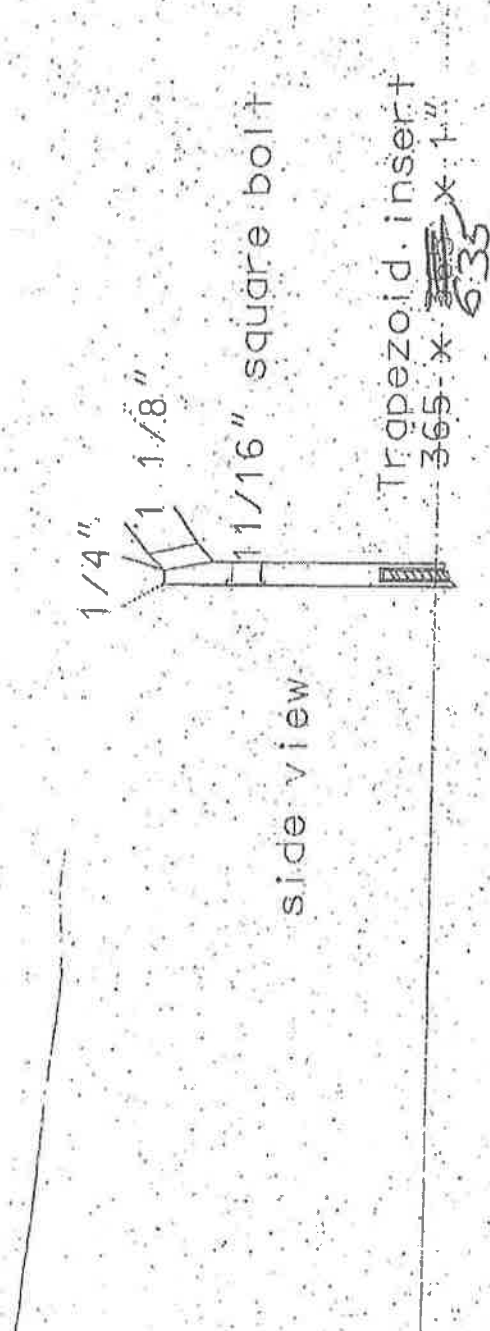

side view

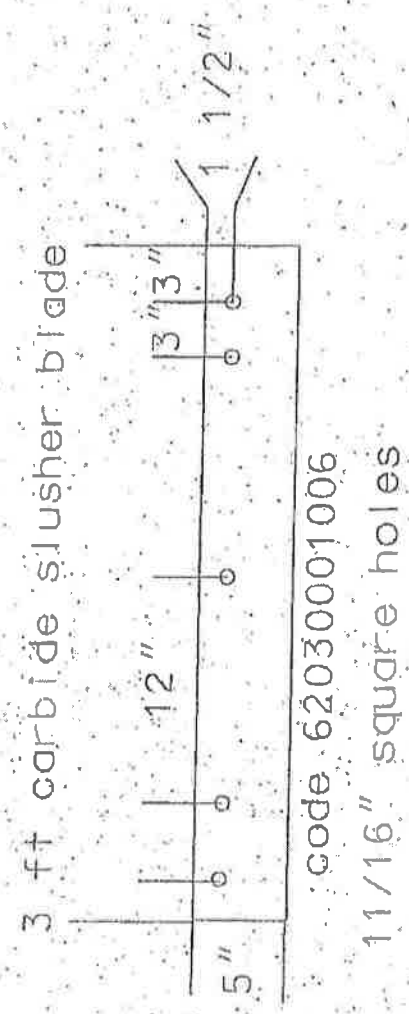

code 62030001006
1 1/16" square holes

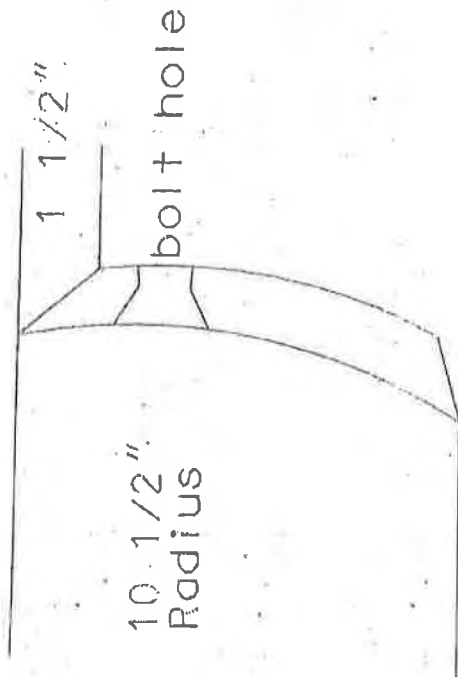

side view

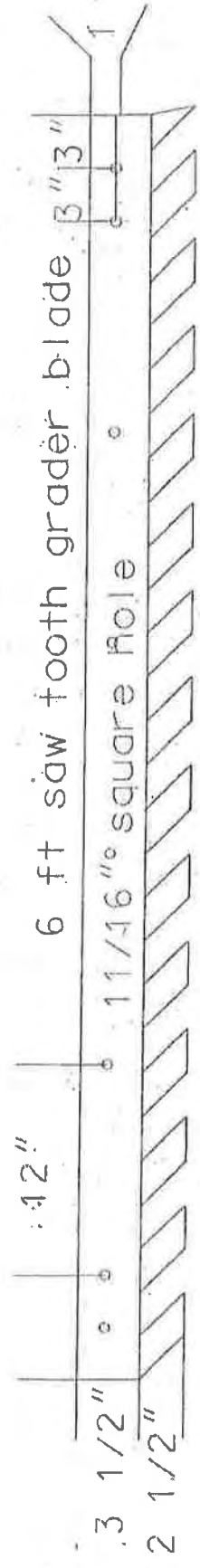

Code 62030001014

115.AP ✓ 13 FOOT WING BLADE

Bid item #10

62030001071

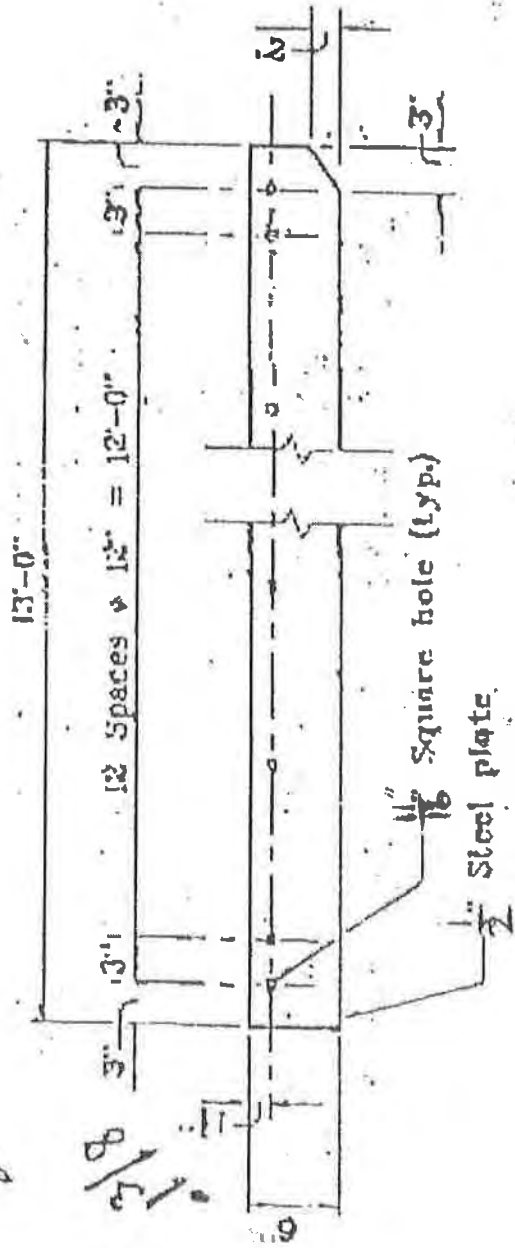

**SNOW PLOW BLADE CUTTING EDGES
DETAILED SPECIFICATIONS
IDAHO**

TUNGSTEN CARBIDE TIPPED

I. MATERIAL SPECIFICATIONS

A. BLADES

1. The blade shall be ¾" (three-quarters of an inch) thick flat, hot-rolled finished steel SAE 1020, or ASTM A36 Structural Grade hot rolled flat bar.
2. Punching shall be 11/16" square holes countersunk to receive 5/8" diameter No. 3 plow bolts.
3. Location and spacing of the holes shall be as shown on the attached drawing, specifically "SNOW PLOW CUTTING EDGE."
4. The groove of the carbide inserts shall be milled in the center of the blade edge.
5. Center of holes shall be in line within 1/32" of established centerline.
6. Lengths of finished blade assemblies shall be 3' and 4' – See Bid Schedule for requested quantities of both lengths.

B. TUNGSTEN CARBIDE INSERTS

1. The inserts shall be high shock WC grade virgin tungsten carbide with a cobalt content not less than 11% or more than 12.5%.

Density: 14.1 Minimum to 14.6 Maximum GMSLCC
Hardness: 87.5 Minimum to 89.0 Maximum Rc. "A" Scale
Transverse Rupture Strength: Minimum 300,000 PSI

"The carbide insert manufacturer and/or bidder shall furnish certification WITH HIS BID SUBMITTAL that the inserts meet the specifications as outlined in this document. Failure to supply such certification with bid submittal will result in the bid being declared non-responsive."

2. Inserts shall be a trapezoid design of the following dimensions:
Height: .635" +/- 0.005" (long angle)
Width: .365" +/- 0.010"
Length: 1" nominal
Bottom Angle: 25 degrees with a nose radius of 1/16" minimum

C. BRAZING AND ASSEMBLY

1. The brazing material shall be high strength alloy type.
2. The braze shear strength shall be minimum 30,000 PSI.

3. The tungsten carbide inserts shall be positioned in the milled groove at .010 between the inserts the entire length of each cutting edge section.
4. The inserts shall be brazed on all sides consistent with sound brazing practice, with no evidence of voids, use of shims, or fillers.
5. Each blade section to contain one insert one inch nominal length for each inch of blade section length.
6. The complete cutting edge shall consist of a combination of three sections with the two end sections interchangeable.
7. The difference between the highest and lowest tip point not to exceed 1/32" on any given blade assembly.
8. The finished blade sections shall be free of warpage and longitudinal deviation not to exceed 1/8" in a four-foot blade section.
9. Each blade section shall be identified with manufacturer's identification label, stamp or stencil on each end of the section.
10. The finished blade sections shall have markings showing the front edge of the blade to avoid improper mounting.
11. The finished blade section shall be given one coat of rust resistant lacquer.

II. CERTIFICATION

Each blade shipment must be accompanied with certification documentation, specifically:

1. A Certificate of Conformance listing or stating
 - a. Manufacturer Work/Job Order Number
 - b. Raw Material lot numbers used in production
 - c. Manufacturing date
 - d. Manufacturer Quality Inspection Manager with contact information
 - e. Conformance to bid specifications
2. Raw Material Certificates of Analysis (aka, "mill" certs)
 - a. Steel
 - b. Tungsten Carbide

III. DELIVERY AFTER RECEIPT OF ORDER (ARO)

All orders must be received by the ordering District(s) within 90 calendar days after order placement. Each District is responsible for placing orders using a Purchase Order.

IV. DELIVERY REQUIREMENTS

It shall be the responsibility of the successful bidder to deliver to an area designated by the District Supply Operations Supervisor(s). A forklift with operator will be provided by the District to assist in unloading.

Blades sections will be bundled with like blades when shipped; do not mix blades in bundles. The blades must be packaged or banded in a manner so that they may be unloaded by a forklift.

Deliveries are to be made between the hours of 8:30 AM to 11:30 AM and 1:00 PM to 4:00 PM Local Time, on weekdays only. No deliveries will be accepted after these hours. No deliveries will be accepted on Saturdays, Sundays and Holidays.

The successful vendor is to notify the customer at the delivery location of any shipment at least 24 hours prior to delivery.

**SNOW PLOW BLADE CUTTING EDGES
DETAILED SPECIFICATIONS
MASSACHUSETTS**

The following general requirements shall apply to all plow blades, both carbon steel and tungsten carbide edge, to be supplied under the Contract governed by this specification.

Shearing:

Shearing is to be within 1/16" of actual dimensions as shown on blueprints, to be clean cut with no burrs. **Flame cuts will not be accepted.**

Blade Sizes:

The length and width of all blades shall be as shown on the accompanying drawings with a maximum tolerance of + or - 1/16".

Punching:

Punching shall be square holes to receive plow bolts. Plow bolts shall not be supplied. Sizes, location and spacing of the holes shall be shown on the attached drawings. Maximum horizontal and vertical tolerance on placement of the centerlines of the punched holes shall be + or - 1/16". **HOLES MUST BE SQUARE. ROUND HOLES ARE UNACCEPTABLE.**

Painting:

Plow blade shall be painted with a black rust-inhibiting paint on both sides to prevent rusting while being stored.

Bundle Size:

Blade edges are to be bundled in lots of ten (10) each of the same type and **bundles are to be strapped together using a 1" strap at three locations.**

Chemical Analysis:

The manufacturer shall take a test ingot during the pouring of each melt of steel used in the manufacture of plow blade cutting edges supplied under this specification. The chemical composition shall be reported to the Department for each delivery of cutting edges and for each melt represented in the shipments means of a Certified Mill Test Report of each heat of steel used. The chemical composition shall conform to the requirements set forth in the paragraph Chemical Composition below. Any shipment not accompanied by a certified chemical analysis shall be rejected and returned at the Contractor's expense. The Contractor shall replace any blades returned with certified blades within fifteen (15) business days of notification.

Chemical Composition:

Carbon Steel Cutting Edges:

The blades shall be made from flat hot-rolled open hearth carbon steel conforming to S.E.A. C-1090 of latest issue and shall have a Brinell hardness of 275 min. and 325. Max. and shall conform to the following analysis of chemical composition.

PERCENTAGE		
<u>Element</u>	<u>Min.</u>	<u>Max.</u>
• Carbon	• 0.85	• 1.00
• Manganese	• 0.60	• 0.90
• Phosphorous	•	• 0.04
• Sulphur	•	• 0.05
• Silicon	•	• 0.30

Tungsten Carbide Tipped Plow Blade Cutting Blade:

Plow Blade

The blades shall be made from flat hot-rolled finished steel conforming to S.A.E. 1021 of latest issue and shall conform to the following analysis of chemical composition:

Percentage		
<u>Element</u>	<u>Min.</u>	<u>Max.</u>
Carbon	0.18	0.23
Manganese	0.60	0.90
Phosphorous		0.04
Silicon		0.05

Tungsten Carbide Inserts:

The inserts shall be fabricated of high stock WC grade tungsten Carbide having cobalt content between 10% and 12%.

	<u>Min.</u>	<u>Max.</u>
Specific Gravity	14:1 min	14.6 max
Hardness:	87.5 min	87.5 min Rockwell "a" Scale
Transverse Rupture Strength	350,000 psi. Min	

The carbide insert manufacture shall furnish with each shipment certification to the purchaser that the inserts conform to the requirements set forth above and Do Not Contain Any Reclaimed Hard scrap Tungsten Carbide. Any shipment delivered without the required certification shall be returned to the Contractor at his expense. The Contractor shall replace all rejected blades with certified blades.

The Contractor shall replace any blades returned within fifteen (15) business days of notification.

The following list of plow blades is to be included on this contract:

Line Item	Size and Description
00010	Viking Plow 1/2" x 6" x 132"
00020	Snow King Plow 3/4" x 6 x 108"
00030	3 ft carbide blade
00040	4 ft carbide blade
00050	41 1/2" x 10" blade (J.D. cutting edge for 544GH loader John Deere DWG # T146673)
00060	14" x 8 1/8" blade (J.D. cutting edge for 544GH loader John Deere DWG # T146672)
00070	Steel plate 1/2" x 8" x 6"
00080	Viking Plow 1/2" x 6" x 120"
00090	Snow King Plow 3/4" x 6" x 96"
00100	Fisher Plow 5/8" x 8" x 96"
00110	John Deere Bucket weld on cutting Edge 1" x 8" x 100"

LINE ITEM # 00010

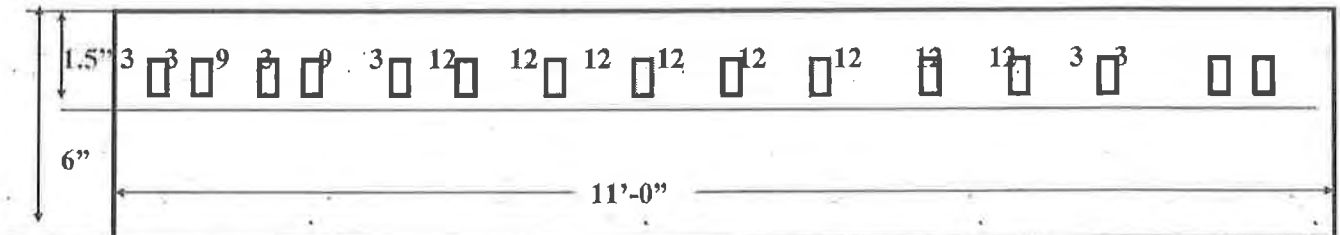

SIZE: 1/2" X 6" X 132"

All holes to be punched 15 holes 11/16" sq. Spaced as shown above.

Plow Blade 1/2" thick

From left to right first two (2) are 3" apart on center, then 9" on center, then 3" on center, then 9" on center, then 3" on center, then the next 7 holes are 12" on center, then 3" on center, then 3" on center

For the Viking plows

Line Item # 00020

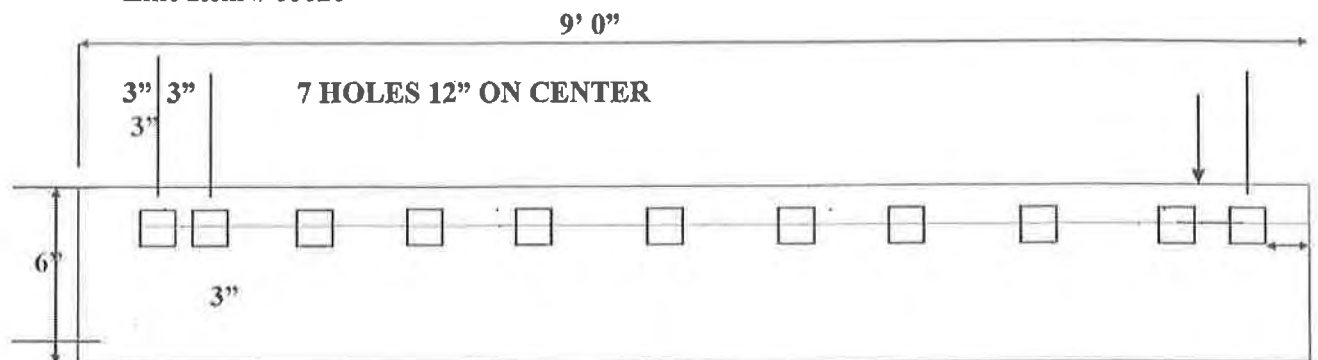

SIZE: 3/4" X 6" X 108"

All holes to be punched 11 holes 11/16" sq. Spaced as shown above.

Plow Blade 3/4" thick

From left to right first two (2) are 3" apart on center, and then the next 7 holes are 12" on center, then 3" on center, then 3" on center

For the Snow-King Plows

Line Item # 00030

Three (3) Foot Tungsten Carbide Edge Plow Blades
Size: 36" x 6" x 3/4"

Line Item # 00040

Four (4) Foot Tungsten Carbide Edge Plow Blade
Size : 48" x 6" x 3/4"

All Holes To Be Punched

5 Holes 11/16" sq. Spaced as Shown Above
Plow Blades 3/4" Thick

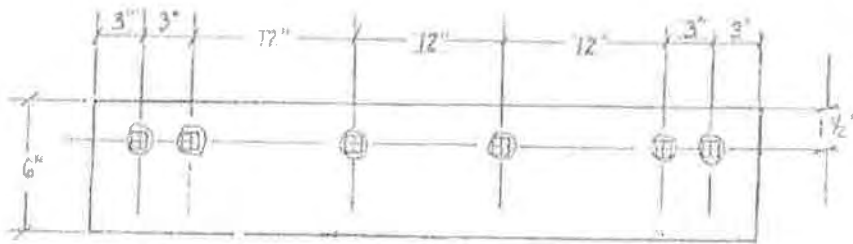

48" CARBIDE SECTION

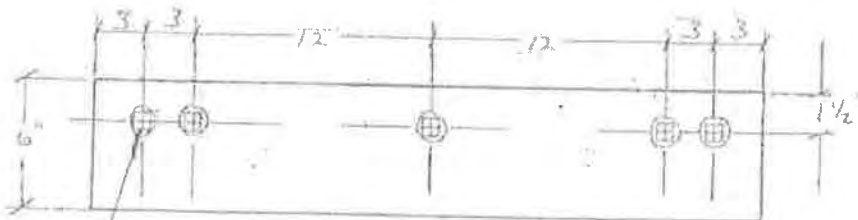

36" CARBIDE SECTION

11/16" SQ. HOLES PUNCHED FOR 5/8" PLOW BOLTS
COUNTER SUNK

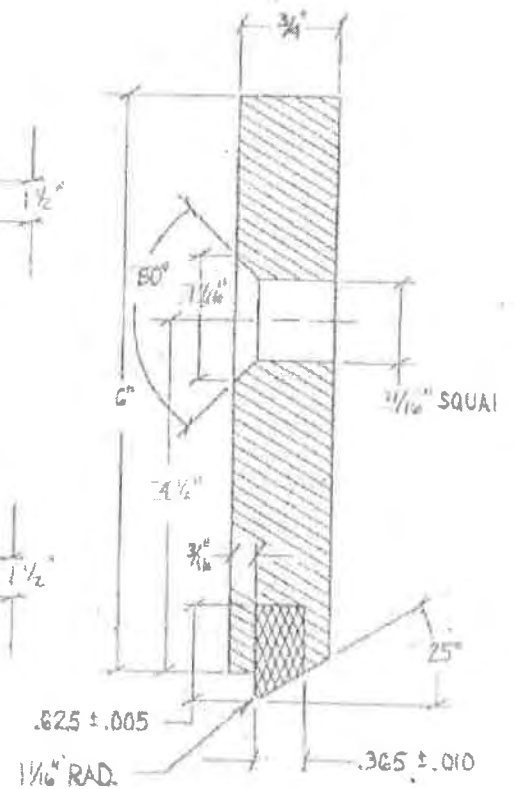

Line Item # 00050
John Deere Cutting Edge for 544GH loader
John Deere DWG # T146673
Size; 1" x 10" x 41.5" Blade
Double Bevel Flat
Bolt Size = 3/4" x 2 3/4"

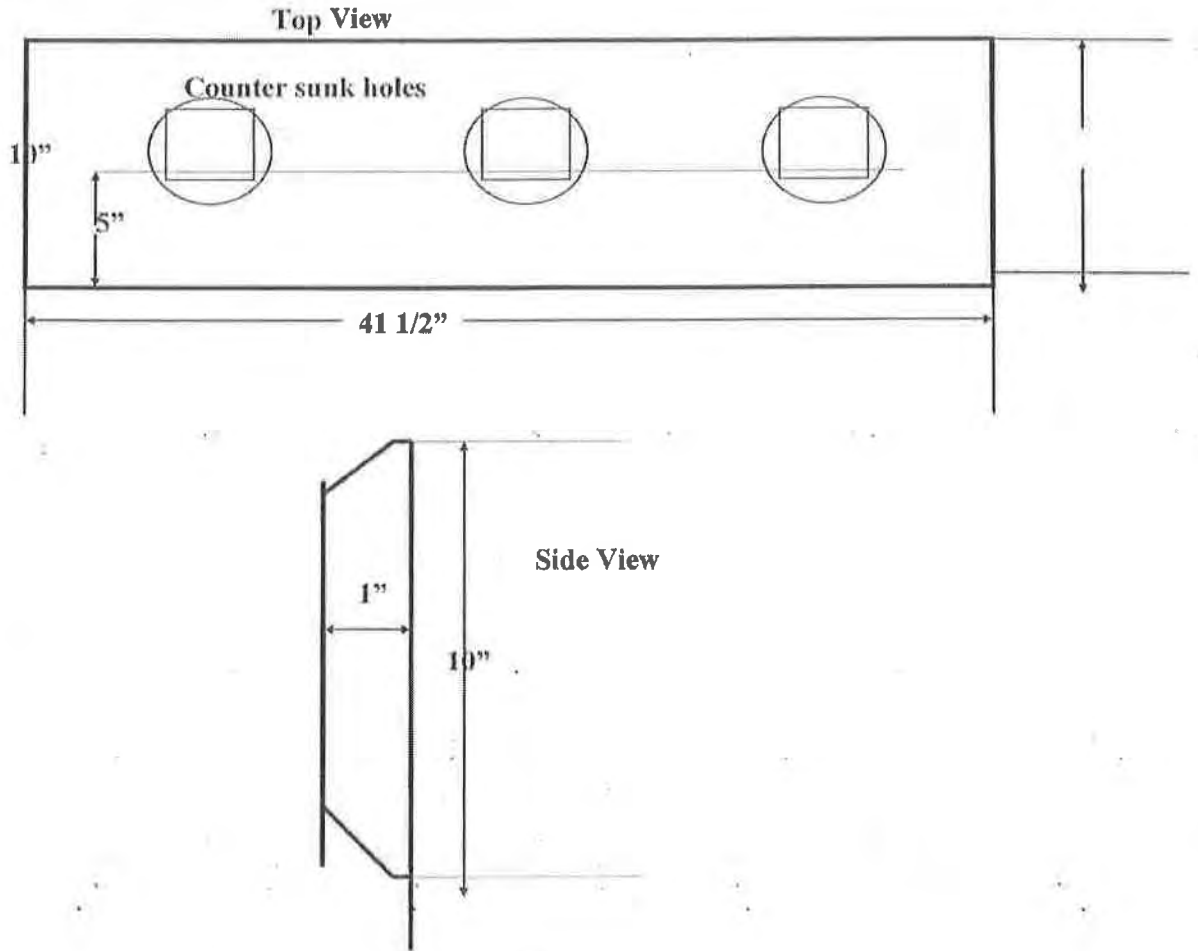

Line Item # 00060
John Deere Cutting Edge for 544GH loader
John Deere DWG # T146672

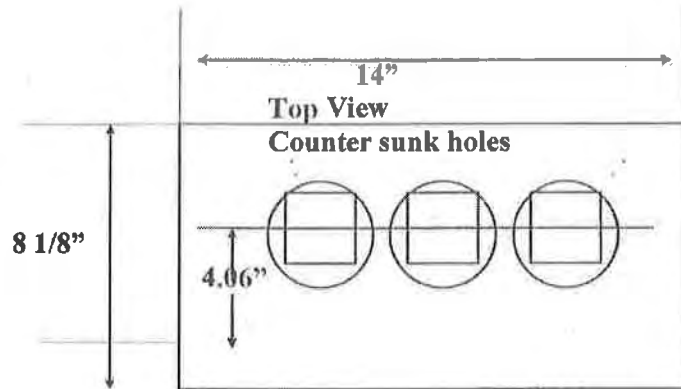

Size; 1" x 14" x 8 1/8" Blade
Double Bevel Flat
Bolt Size = 3/4" x 2 3/4"

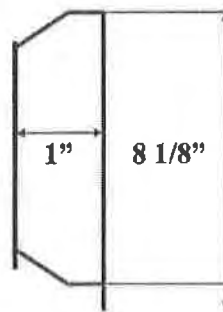

Side View

Line Item # 00070

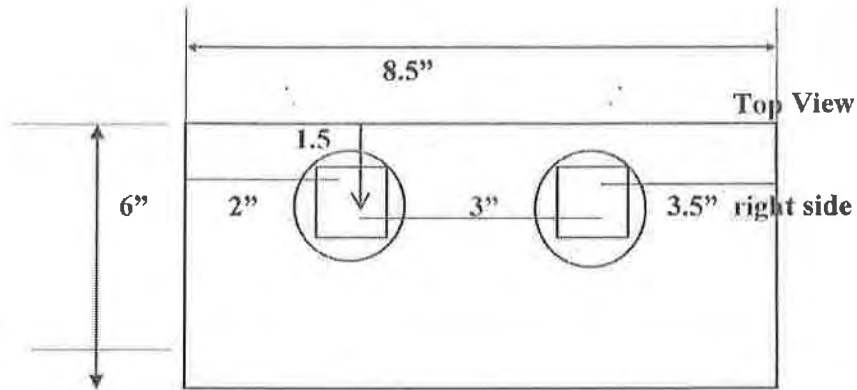

Counter sunk holes
Holes are 1 1/2" FROM TOP
Size; 5/8"x 6" x 8.5" Blade
Steel Plate to make curb shoes

Line Item # 00080

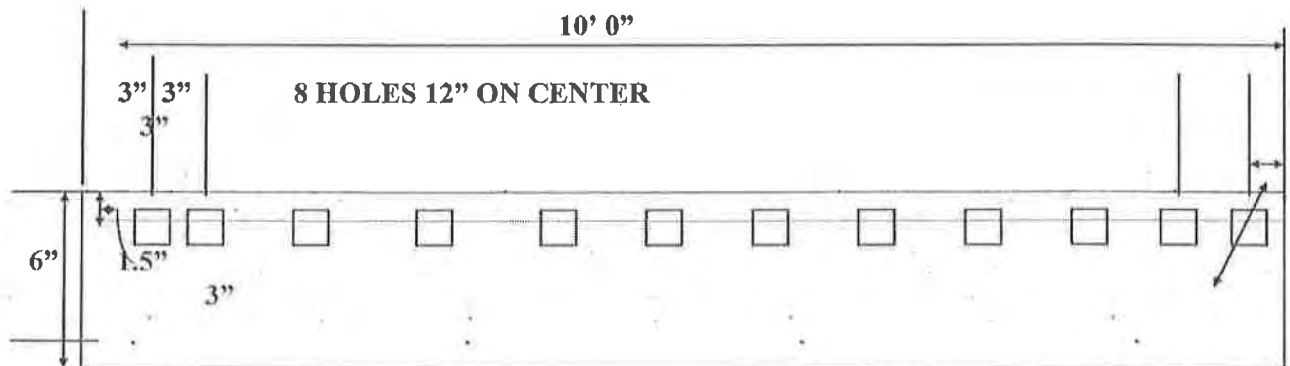

SIZE: 1/2" X 6" X 120"

All holes to be punched 12 holes 11/16" sq. Spaced as shown above.

Plow Blade 1/2" thick

From left to right first two (2) are 3" apart on center, and then the next 8 holes are 12" on center, then 3" on center, then 3" on center

For the Viking Plows

Line Item # 00090

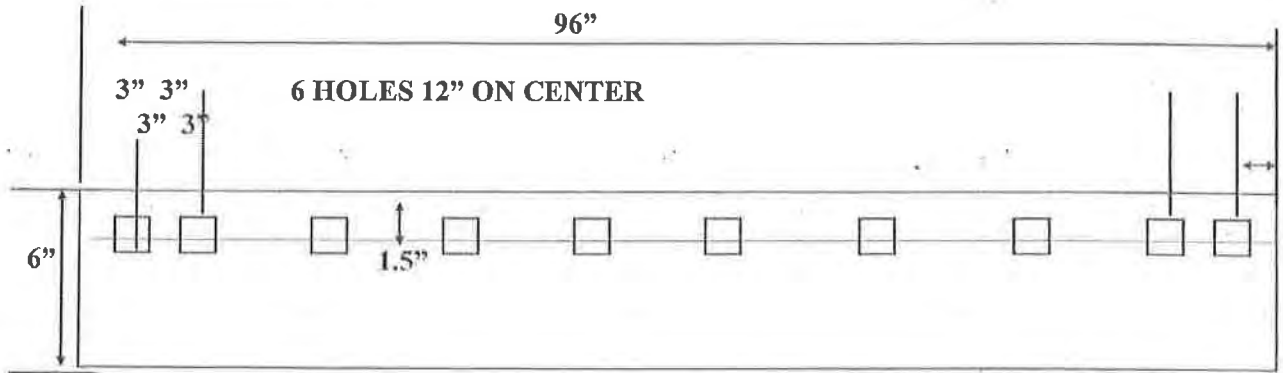

SIZE: 3/4" X 6" X 96"

All holes to be punched 10 holes 11/16" sq. Spaced as shown above.

Plow Blade 3/4" thick

From left to right first two (2) are 3" apart on center, and then the next 6 holes are 12" on center, then 3" on center, then 3" on center

For the Snow King Plows

Item # 00100

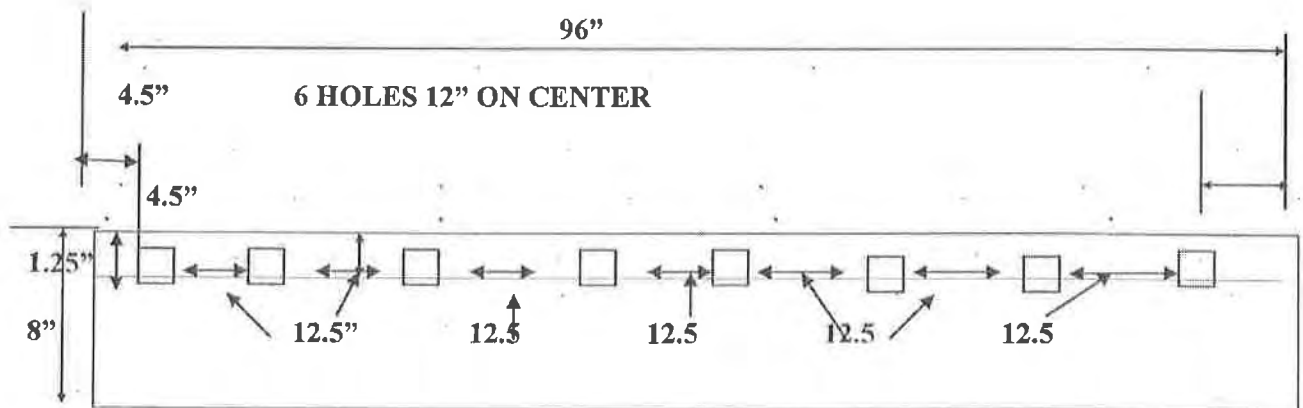

SIZE: 5/8" X 8" X 96"

All holes to be punched 6 holes 11/16" sq. Spaced as shown above.

Plow Blade 5/8" thick

From left to right first hole is 4.5" apart on center, and then the next 6 holes are 12.5" on center, then the last hole is 4.5" on center from the right side end

For the Fisher Plows

Item # 00110

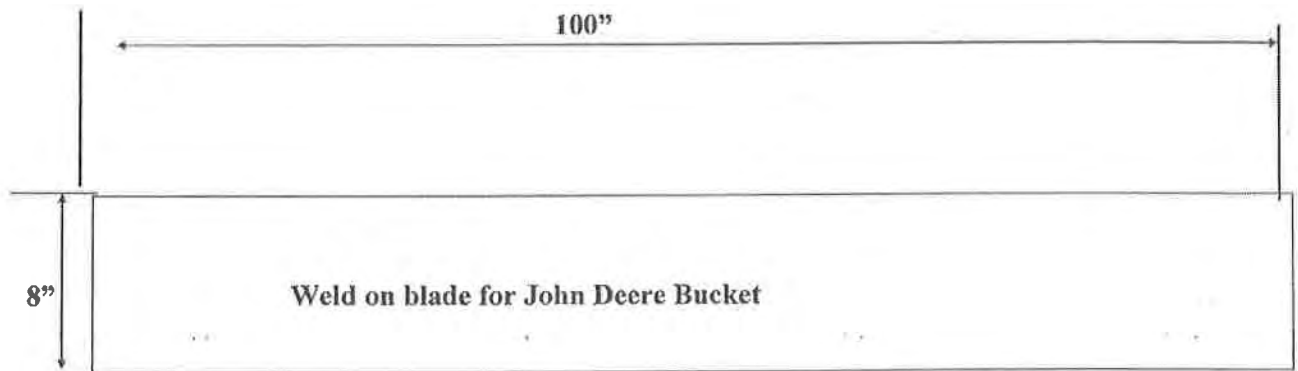

SIZE: 1" X 8" X 100"

KÜPER

KÜPER

**Kueper Plow Blade
Specification:**

**TUCA SX Carbide Tipped Snowplow
Blades**

Presented by Kueper North America, LLC

2012

About this Specification

© 2012 Kueper North America, LLC. All Rights Reserved. All other brands and names may be trademarks of their respective owners and are used for explanation without intent to infringe.

1. Description:

This specification covers snowplow blades with tungsten carbide inserts free floating in vulcanized rubber with the configuration of -STEEL-RUBBER-STEEL WITH CARBIDE INSERTS-RUBBER - STEEL.

2. Materials:

Front Steel Plate:

Wear resistant steel with an average hardness of 400 HB,

1. matching the wear and hardness specifications of Dillidur 400 V.
 - **Front Steel Plate thickness: 8 mm**
 - **Hardness: 400 HB (43 Rockwell C, 114 Rockwell B)**
 - **Tensile Strength: U.T.S. = 1300 MPa**
 - **Yield Point: Y.P. = 1000 MPa**
 - **Tolerances according to specifications of Dillidur 400V.**
 - **Shape: Front plate to be formed in a "wave" shape in order to better deflect snow into the mold-board of the plow. Front plate to have triangular openings as wear indicator and to permit snow to cool the carbide.**

Back Steel Plate:

Wear resistant steel with an average hardness of 400 HB

2. matching the specifications of Dillidur 400 V.
 - **Back Steel Plate thickness: 8 mm**
 - **Hardness: 400 HB (43 Rockwell C, 114 Rockwell B) (tolerance \pm 30 HB)**
 - **Tensile Strength: U.T.S. = 1300 MPa**
 - **Yield Point: Y.P. = 1000 MPa**
 - **Tolerances according to specifications of Dillidur 400V.**
 -

3. **Rubber: The blade shall have a wear resistant rubber body, vulcanized between the two steel plates with tungsten carbide holders and inserts embedded within the rubber.**

4. Tungsten Carbide Inserts:

- **Tungsten carbide inserts shall be centrically embedded on the lower end of a steel plate (=steel carbide holder).**
- **The inserts shall be a high shock WC Grade of tungsten and shall meet Virgin Tungsten Carbide quality specifications and the following requirements:**
 1. **Hardness: 1100-1300 HV10 ISO 3878**
 2. **Bending Strength: 2700 N/mm (squared) ISO 3327**
 3. **Average Grain Size: 5 – 7 μ m**
 4. **Density: 14,40 g/cm³ ISO 3369**
 5. **Insert Dimensions:**
 6. **Height: 17,5 mm**
 7. **Width, 8 mm**
 8. **The groove for the carbide shall be milled in the center of the steel carbide**

holder. The groove shall be milled to a depth that will allow the inserts to be brazed flush with the bottom edge of the carbide holder.

9. Each insert shall be max. two-inches nominal length.

10. The inserts shall be brazed on all contact surfaces consistent with sound brazing practice with no evidence of voids or use of shims. Brazing shall be of such strength and quality as required to prevent movement or loss of the inserts during use.

3. Finished Blades

3.1 Overall blade dimensions:

1. **Blade Thickness in wear area: 40 mm (tolerance ± 2 mm)**
2. **Overall Blade Height: 187 mm (tolerance ± 2 mm)**

3.2 Physical Requirements. All blades shall be straight and free from flaws and injurious defects, and shall have workmanlike finish.

3.3 Tungsten carbide holders shall be placed free-floating in the rubber body. Thus there has to be a slight gap between two holders in order for the holders to act independently of one another and "flex". In length carbide inserts should cover no less than 90% of the total length of the blade.

3.4 Punching shall be square or round holes. Details, location, and spacing of the holes shall be to customer requirements.

3.5 Blade punching will be of such accuracy, both for the spacing between holes and for the spacing between the end hole and the end of the blade, that the blades will fit the moldboards, thus making the blade sections interchangeable.

3.6 Blades shall be painted and any paint used to coat the blades shall be dry prior to shipment and shall not smear or track during handling.

3.7 Each blade element should provide the name of the manufacturer and a serial number for quality control.

3.8 Finished blade sections shall be provided in units of three (3) feet, four (4) feet, five (5) feet, or any other measure in length.

3.9 The finished blade section shall be fully assembled by the manufacturer and require no additional assembly, no additional parts or hardware, and no mounting hardware other than bolts and nuts.

Figure 1: Blade Dimensions

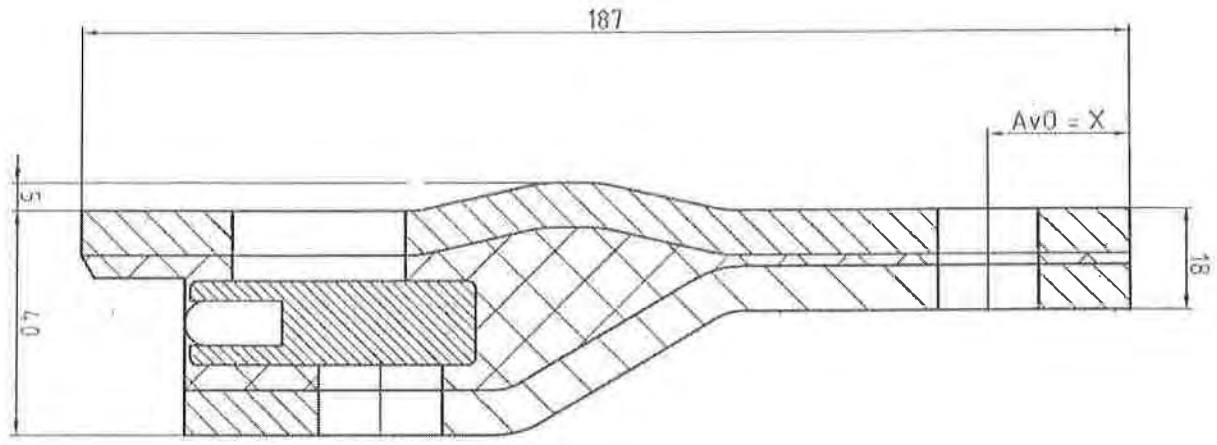
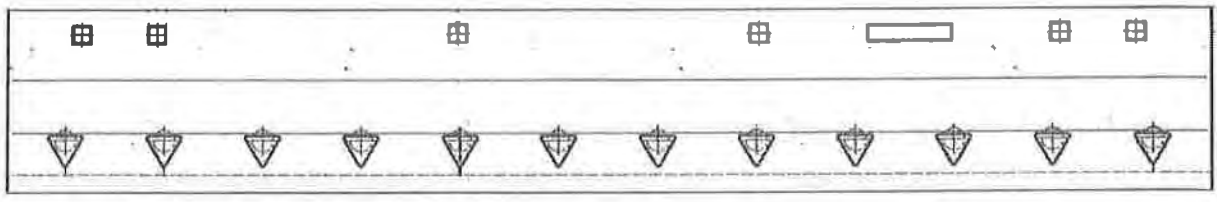

Figure 2: AASHTO Hole Positioning (4')



**SNOW PLOW BLADE CUTTING EDGES
DETAILED SPECIFICATIONS
ALASKA**

No. 1 - Regular Curved Blades:

Blades shall be heat treated, through hardened, with a Rockwell hardness of 43 to 55 or a Brinell hardness of 408 to 548, and rated EXTREME SERVICE. Blade width shall be 8 inches. Blades shall have the following bolt hole spacing: the first two holes on each end of the blade shall be 3 inches apart; the remaining holes shall be 6 inches apart. Example: (3-3-6-6). Bolt holes shall be square and countersunk.

Length of blades shall be one of the following standard sizes:

- 1-a: 3 feet
- 1-b: 4 feet
- 1-c: 6 feet
- 1-d: 7 feet
- 1-e: 8 feet

Blade thickness shall be either:

- 1-f: 3/4 inch
- 1-g: 1 inch

Blades shall be curved with double bevel sections having standard AASHTO highway punching for either:

- 1-h: 5/8 inch diameter bolts
- 1-i: 3/4 inch diameter bolts

No. 2 - Regular Flat Blades / Heat Treated:

Blades shall be heat treated, through hardened, with a Rockwell hardness of 43 to 55 or a Brinell hardness of 408 to 548. Blades shall be either top punched or center punched, as specified in the order. Blades shall have the following bolt hole spacing: the first two holes on each end of the blade shall be 3 inches apart; the remaining holes shall be 6 inches apart (3-3-6-6). Bolt holes shall be square and countersunk.

Length of blades shall be one of the following standard sizes:

- 2-a: 4 feet
- 2-b: 5 feet
- 2-c: 6 feet
- 2-d: 7 feet
- 2-e: 8 feet
- 2-f: 9 feet
- 2-g: 10 feet

- 2-h: 11 feet
- 2-i: 12 feet
- 2-j: 14 feet

Blade width shall be either:

- 2-k: 6 inches
- 2-l: 8 inches
- 2-m: 10 inches

Blade thickness shall be either:

- 2-n: 1/2 inch
- 2-o: 3/4 inch
- 2-p: 7/8 inch
- 2-q: 1 inch

Blades shall be flat sections having standard AASHTO highway punching for either:

- 2-r: 5/8 inch diameter bolts
- 2-s: 3/4 inch diameter bolts

No. 3 - Regular Flat Blades / High Carbon:

Blades shall be high carbon with a Rockwell hardness of 24 to 36 or a Brinell hardness of 247 to 337. Blades shall be either top punched or center punched, as specified in the order. Blade width shall be 8 inches. Blades shall have the following bolt hole spacing: the first two holes on each end of the blade shall be 3 inches apart; the remaining holes shall be 6 inch apart (3-3-6-6). Bolt holes shall be square and countersunk.

Length of blades shall be one of the following standard sizes:

- 3-a: 9 feet
- 3-b: 12 feet
- 3-c: 14 feet

Blade thickness shall be either:

- 3-d: 3/4 inch
- 3-e: 5/8 inch
- 3-f: 7/8 inch

Blades shall be flat sections having standard AASHTO highway punching for either:

- 3-g: 5/8 inch diameter bolts
- 3-h: 3/4 inch diameter bolts

No. 4 - Scarifier Blades/1.4" Tooth Width:

Blades shall be heat treated, through hardened with a Rockwell hardness of 38 to 50 or a Brinell hardness of 357 to 488. Blade width shall be 8 inches. Blades shall have the following bolt hole spacing: the first two holes on each end of the blade shall be 3 inches apart; the remaining holes shall be 6 inches apart (3-3-6-6). Bolt holes shall be square and countersunk.

Length of blades shall be one of the following standard sizes:

- 4-a: 3 feet
- 4-b: 4 feet
- 4-c: 6 feet
- 4-d: 7 feet

Blade thickness shall be either:

- 4-e: 3/4 inch
- 4-f: 1 inch

Blades shall be curved, double bevel sections, having standard AASHTO highway punching for either:

- 4-g: 5/8 inch diameter bolts
- 4-h: 3/4 inch diameter bolts

Teeth shall be of straight design with 1 inch spacing. Teeth shall be 1.4 inch wide by either:

- 4-i: 4.25" long
- 4-j: 2.5" long

No. 5 - Scarifier Blades / 2.5" Tooth Width:

Blades shall be heat treated, through hardened, with a Rockwell hardness of 38 to 50 or a Brinell hardness of 357 to 488. Blade width shall be 8 inches. Blades shall have 2.5 inch tooth width. Blades shall have the following bolt hole spacing: the first two holes on each end of the blade shall be 3 inches apart; the remaining holes shall be 6 inches apart (3-3-6-6). Bolt holes shall be square and countersunk.

Length of blades shall be one of the following standard sizes:

- 5-a: 3 feet
- 5-b: 4 feet
- 5-c: 6 feet
- 5-d: 7 feet

Blade thickness shall be either:

- 5-e: 3/4 inch
- 5-f: 5/8 inch

5-g: 1 inch

Blades shall be curved, double bevel sections, having standard AASHTO highway punching for either:

5-h: 5/8 inch diameter bolts

5-i: 3/4 inch diameter bolts

Teeth shall be of straight design with 1-1/2" spacing. Teeth shall be 2-1/2" wide by either:

5-j: 4.25 inch long

5-k: 2.5 inch long

No. 6 - Single Carbide Insert Blades:

Blades shall be flat, hot rolled steel, must meet or exceed grade SAE 1020 specifications. Length of blades shall be one of the following standard sizes:

6-a: 3 feet

6-b: 4 feet

6-c: 5 feet

Blade width shall be either:

6-d: 5 inches

6-e: 6 inches

6-f: 8 inches

Blade thickness shall be either:

6-g: 3/4 inch

6-h: 7/8 inch

6-i: 1 inch

Blades shall be top punched 1.5 inches from the top of the blade to the center of the line of bolt holes. The first two holes on each end of the blade shall be 3 inches apart, center-to-center, the remaining holes shall be 6 inches apart center-to-center. Example: (3"-3"-6"-6"-6"-6"-3"-3"). The slots for the carbide inserts shall be milled in the center of the blade edge. The inserts shall be high shock WC grade Tungsten Carbide with 11% to 12.5% cobalt content. The carbide density shall be 14.1 (min.) to 14.6 (max.) gms/cc. The carbide insert hardness shall be from 87.5 (min.) to 89.0 (max.) on the Rockwell "A" scale. The inserts shall be of trapezoidal design and measure approximately .635 inch high x .365 inch thick x 1 inch long. The bottom angle shall be 25 degrees with a 1/16 inch minimum nose radius.

Blades shall be punched with square countersunk holes for either:

6-j: 5/8 inch diameter bolts

6-k: 3/4 inch diameter bolts

No. 7 - Dual Carbide Insert Blades:

Blades shall be flat, hot-rolled steel, must meet or exceed SAE 1020 specifications. Blade thickness shall be 7/8 inch. The blade length of the blade shall be one of the following standard sizes:

7-a: 2 feet

7-b: 3 feet

7-c: 4 feet

7-d: 5 feet

Blade width shall be either:

7-e: 5 inches

7-f: 6 inches

Blades are to be punched with square countersunk holes for either:

7-g: 5/8 inch diameter bolts

7-h: 3/4 inch diameter bolts

Blades shall be top punched 1.5 inches from the top of the blade to the center of the line of bolt holes. The first two holes on each end of the blade shall be 3 inches apart, center-to-center, the remaining holes shall be 6 inches apart center-to-center. Example: (3"-3"-6"-6"-6"-6"-3"-3"). The top edge of the blade (opposite the carbide edge) shall be beveled at a 32 degree angle leaving an approximately .34 inch blunt dimension at the end of the blade to fit to motor grader moldboards. There shall be two rows of Tungsten carbide inserts brazed into an open-faced recess along the entire bottom edge of the blade. The front row of inserts shall be rectangular and measure approximately .75" high x .32" thick with each insert approximately 2 inches long. The front row of inserts shall be a grade SP341 Macro crystalline type WC, tungsten carbide insert with a hardness of 83.5 - 85.0 on the Rockwell "A" scale. The second rear row of inserts shall be trapezoidal and measure approximately .63 inch high x .38 inch thick with each insert approximately 1 inch long. The bottom angle shall be 25 degrees with a 1/16 inch minimum nose radius. The second row of inserts to be a high shock WC grade of tungsten carbide with 11% to 12.5% cobalt content with a hardness from 87.5 (min.) to 89.0 (max.) on the Rockwell "A" scale.

No. 9 – Brand Specific Blades

All blades in this lot are brand specific. Only Caterpillar Inc. **part number 109-3124** will be accepted. No substitutions.

**SNOW PLOW BLADE CUTTING EDGES
DETAILED SPECIFICATIONS
UTAH**

1. General Information

2. References

- 2.1 **ASTM B276-05(2010)** Standard Test Method for Apparent Porosity in Cemented Carbides (or latest edition)
- 2.2 **ASTM B294-10** Standard Test Method for Hardness Testing of Cemented Carbides (or latest edition)
- 2.3 **ASTM B311-08** Standard Test Method for Density of Powder Metallurgy (PM) Materials Containing Less Than Two Percent Porosity.
- 2.4 **ASTM B390-92(2000)** Standard Practice for Evaluating Apparent Grain Size and Distribution of Cemented Tungsten Carbides (or latest edition)

3. Blade

- 3.1 The blade shall be flat hot-rolled finished steel to meet or exceed specifications for A36 or 1020 - type steel.
- 3.2 Dimensions:
 - Length: Blade shall be 48" long, (-0.06", + 0.00" long.)
 - Height: 6" (+.09", -.06")
 - Thickness: 0.75" (3/4")
- 3.3 Punching shall be standard highway 11/16" square, counter-sunk to receive 5/8" diameter No. 3 head plow bolts, gauged 2" from the top of the blade to center of hole. The centerline of the holes shall be in line ± 0.03 " of established horizontal centerline and 0.06" of established vertical centerline.
- 3.4 Carbide inserts groove shall be milled in the center of the blade edge.
- 3.5 The finished blade section shall be free of warpage and longitudinal deviation not to exceed 0.125" in either direction in a four-foot section.
- 3.6 Identify each blade with the manufacturer's identification stamp or marking.
- 3.7 The finished sections shall have markings showing the front edge of the blade to avoid improper mounting.

4 Tungsten Carbide Inserts

- 4.1 The inserts shall be a high shock WC grade of tungsten carbide with
 - A. 11 to 12 percent cobalt content.
 - B. Tungsten carbide content 87.0 to 88.0 percent

- C. All other constituents – not more than 1.0 percent maximum
- 4.2 Each blade section to contain one insert, one-inch nominal length for each inch of blade section length.
- 4.3 Inserts shall be constructed of tungsten carbide, rectangular in design. Each blade shall contain 48 inserts with the following dimensions:
- | | |
|---------|------------------|
| Height: | 0.760" +/- 0.010 |
| Width: | 0.360" +/- 0.005 |
| Length: | 1" nominal |
- 4.4 Using a statistically valid sampling plan determine the following parameters are met with a minimum confidence level of 95 percent:
- A. Surface cracks as determined by visual examination under a 3-power microscope – maximum of 15 percent of insets show cracks
 - B. Density: 14.0 to 14.5 g/cc
 - C. Hardness 88.0 to 90.5 HRA
 - D. Porosity: (1) A00 – A04
(2) B00 – B02
(3) C00 – C04
 - E. Grain size (1) 10M/10C
(2) 15 percent or less of samples have no large voids or “void clusters” when viewed under a 200-power microscope
- 4.5 The tungsten carbide inserts shall be positioned in the milled groove at approximately .010” between the inserts the entire length of each cutting edge section.
- 4.6 The difference between the highest and the lowest tip point between any two adjacent inserts shall not exceed 0.03” on any blade assembly.
- 4.7 Quality control documentation - Vendor shall furnish documentation that quality control testing of carbide inserts was conducted at the tungsten carbide manufacturing plant to confirm that the inserts meet the requirements 4.1 through 4.4
- 4.8 Quality Assurance Testing – Customer will select samples from supplied blades and subject them to Quality Assurance Testing. If Quality Assurance Testing does not confirm that the blades do not meet the specification then the blades will be rejected.
- 4.9 Customer reserves the right to test any snow plow blade supplied under this specification at any time. If customer testing fails to confirm vendor-supplied test results, the shipment represented may be rejected.
- 4.10 Disposition of Rejected Blades – Vendor shall remove rejected blades from Customer property and replace them at no cost to customer.

- 4.11 Alternative Disposition of Rejected Blades – Customer at its' sole discretion, may elect to use rejected blades with a net 25% reduction in payment to the vendor.

5.0 Brazing

- 5.1 Brazed alloy joint must be comprised of a high strength alloy material that has shear strength to withstand 30,000 minimum PSI. The filler material contains no cadmium.
- 5.2 Braze inserts on all sides consistent with sound brazing practice with no evidence of voids or use of shims. Due to the thickness of the braze joints between inserts it may be necessary for several inserts to be slightly shorter or longer than the nominal 1" length to insure the carbide insert runs the entire length of the blade without protruding from the end of the steel body.

**SNOW PLOW BLADE CUTTING EDGES
DETAILED SPECIFICATIONS
NEW HAMPSHIRE**

TUNGSTEN CARBIDE TIPPED SNOW PLOW BLADES

1. BLADE

1.1 Blades shall be flat hot-rolled finished steel SAE 1020 of domestic manufacture.

1.2 Punching shall be 11/16" square holes to receive 5/8" diameter carriage bolts. Location and spacing of the holes shall be as shown on the attached drawings.

1.3 The groove for the carbide inserts shall be milled in the center of the blade edge.

1.4 Center of holes shall be in line within 1/32" of established centerline.

2. TUNGSTEN CARBIDE INSERTS

2.1 The inserts shall be WC grade of tungsten carbide with 11% to 12% cobalt content.

Density: 14.1 minimum to 14.6 maximum.

Hardness: 87.5 minimum to 89.0 maximum Rockwell "A" Scale.

Transverse Rupture Strength (P.S.I.): 350,000 minimum.

Porosity: (ASTM B276-79) A 06
B 00
C 00

2.3 Insert Design.

The inserts shall be trapezoidal in shape to the following dimensions:

Height: .750 + .005 (Long side)

Width: .365 + .010

Length: 1 in. nominal

Bottom Angle: 25 degrees with a nose radius of 1/16" minimum.

2.4 A metallurgical evaluation of the carbide insert shall show no evidence of cross grade contamination. Evaluation to be based on a photo micrograph of a polished and etched specimen at 500X magnification.

3. BRAZING

3.1 The brazing material shall be a high strength alloy type. The braze shear strength to be 30,000 psi minimum.

3.2 The tungsten carbide inserts shall be positioned in the milled groove at .010 between the inserts the entire length of each cutting edge section.

3.3 The inserts shall be brazed on all sides consistent with sound brazing practice with no evidence of voids or use of shims.

3.4 Each blade section to contain one insert, one-inch nominal length for each inch of blade section length. Reference 2.3.

4. SPECIFIC REQUIREMENTS

4.1 The complete cutting edge shall consist of a combination of three sections with the two end sections interchangeable.

4.2 The difference between the highest and lowest tip point between two adjacent inserts is not to exceed 1/32" on any given blade assembly.

4.3 The finished blade sections shall be free of warpage and longitudinal deviation not to exceed 1/8" in a 44" blade section.

4.4 Each blade section shall be identified with the manufacturer's identification stamp, month and year on each end of the section.

4.5 The finished blade sections shall be given one coat of * "lead free" rust resistant lacquer and with markings showing the front of the blade to avoid improper mounting. However, the carbide edge of the blade section shall not be lacquer coated to allow ready physical inspection.

4.6 Each blade is to be numbered at each end by stamping onto the metal 3/8" letters and numerals either 28C, 40, 44C or 44E as appropriate.

5. SPECIAL PROVISIONS

5.1 The Vendor guarantees the finished product to meet all specifications and to be free from defects in materials and workmanship and that it will perform the

work of snow, ice and slush removal when in use on all types of paved systems. The Vendor also guarantees to make an adjustment to the customer for a period of 30 months after acceptance by the customer on any blade section with 25% or more of wear left in the edge which fails in any of the following respects:

1. Loss of one or more carbide tips.
2. Shattering along the longitudinal plane.
3. Shattering along a plane in or about the line of travel.

Wear on a blade section is defined as follows:

* "Lead free"- shall be consistent with 16 CFR Part 1303,2(b)(2).

The amount of wear on a blade section shall be determined by measuring the depth remaining on the insert nearest each end of the blade section which has not been damaged due to side exposure; taking the average of the depths so measured; and indicating this average depth as a percentage of the depth of an insert as originally mounted in the blade section. The depth measurement will be taken parallel to the plane of the blade section.

- 5.2 The Vendor's guarantee will not apply when the cause of failure of a blade section can be attributed to negligence on the part of the operator, such as, but not limited to; striking abutments or other obstructions, faulty installation of a blade section; uneven plow balance; or other poor operating practices.

The customer warrant in requesting any adjustment on a blade section that:

1. The blade section was used only in the manner ordinarily employed in the removal of snow, ice and slush.
2. The blade section was securely bolted to the moldboard when in use to prevent blade chatter.
3. Inspection was made before each patrol of the blade sections to insure that all bolts were tight.

- 5.3 Adjustments on blade sections under Paragraph 5.1 subject to the provisions of Paragraph 5.2 will be made by the Vendor as follows:

- a. The Vendor will replace without charge any blade section which fails in any respect enumerated before 25% wear has occurred.
- b. If blade section failure occurs after 25% of the wear life of the blade has occurred and before 75% of the wear life has occurred, the Vendor will replace the blade section for a charge which is proportional to the amount of service life rendered for the blade section based on the wear which has occurred.
- c. There shall be no replacement of, or adjustment on, a blade section which has less than 25% wear life left therein.

5.4 Each blade section on which a claim of adjustment is made will be returned promptly by the customer to the Vendor, freight prepaid, with a written claim for adjustment.

The Vendor, upon determining that an adjustment on the blade section is in order, will notify the customer that an adjustment is to be made and what charge, if any, is to be made for the adjustment, and will ship promptly the replacement blade section to the customer, freight prepaid.

5.5 Each bidder shall submit a sample blade section for examination of workmanship acceptability. The blade section submitted by the successful bidder shall be retained by the State as a standard for quality comparison purposes against the delivery quantity.

5.6 Each bidder shall submit a shop drawing of the blade sections with the proposal.

**SNOW PLOW BLADE CUTTING EDGES
DETAILED SPECIFICATIONS
NEW HAMPSHIRE**

Grader Blades

All blades are to be domestic or Canadian manufactured and must be of North American steel.

Blades are to be through hardened to Brinell 400 minimum and carry a full guarantee against breakage. If a blade breaks during its lifetime it shall be replaced without charge by the vendor. Blades are to have both edges beveled, both ends square, with 6" punching for 5/8" No. 8 plow bolts, lacquered but without nuts and bolts. The bevel and edge thickness dimensions are to be to the manufacturer's standard.

Length	plus or minus' 1/16"
Cord width	plus 1/8" minus 3/32"
Thickness	plus or minus 1/64"
Camber	1/8" in 5' maximum
Shipping wt.	3/4" x 72" blade approx. 113 Lbs. 3/4" x 84" blade approx. 132 Lbs.

Blades shall be painted with rust inhibiting lead free paint on all sides.
Material safety data sheets for paint used must accompany all shipments.

Blades subject to test and inspection upon delivery.

Blades must be packaged 10 per bundle.

**SNOW PLOW BLADE CUTTING EDGES
DETAILED SPECIFICATIONS
MAINE**

Bucket Blades

All blades are to be domestic or Canadian manufactured and must be of North American steel.

Blades are to be through hardened to Brinell 400 minimum and carry a full guarantee against breakage. If a blade should break during its lifetime it shall be replaced without charge by the vendor. Blades to have a 30 degree beveled edge, both ends square.

Bucket blade specification BB1 to BB4 have a 13/16" square punched hole, 1 5/16" countersunk to accommodate a 3/4" grade 8 plow bolt with No. 3 head. Bucket blade BB5 must have a 1 1/16" square punched hole countersunk to 1 1/16" to accommodate a 5/8" grade 8 plow bolt with a No. 3 head. Blades BB6 and BB7 shall be punched and countersunk for 1" No. 3 plow bolts.

Blades shall be painted with rust inhibiting lead free paint on all sides. Material safety data sheets for paint used must accompany all shipments.

Blades will be subject to inspection upon delivery.

Blades must be packaged 10 per bundle.

RC42 - 50 below decarb.

RC30 minimum at .48.

BB3 = Bucyrus Part No. 101639M & John Deere Part No. T146672

BB\$ = Bucyrus Part No. 101638M & Valk Part No. HEAFDB.625x8x8

**SNOW PLOW BLADE CUTTING EDGES
DETAILED SPECIFICATIONS
NEW HAMPSHIRE**

FLEXIBLE PLOW BLADES

Plow Edge

General Specifications

The plow edge blade shall consist of individual steel segments encased in rubber with steel bushings positioned on 12" centers for mounting to the plow. Each segment shall be milled to a special shape and profile and inserted with tungsten carbide bits, brazed in place along the wear edge.

Finished Specifications

The finished blade shall be approximately 7/8" thick by 6" wide weighing 9.75 lbs. per foot. 11/16" ID steel bushings shall be located 1.5" from the top of the blade on 12" centers to facilitate mounting to the *plow*. Each blade shall have blade orientation embossed in the rubber casing.

A 1/2" x 3" heat-treated 15B30 clamp bar shall be mounted on top of the plow blade to hold the blade on the plow. This clamp bar weighs approximately 5 lbs. per foot and has 11/16" square holes located on 12" centers to align with the bushings in the blade and shall be a part of the plow edge.

Complete nut and bolt sets shall be provided with each plow edge.

Steel Segment

1. Cast steel 0.75" thick by 5" wide and 11.22" long.
2. The top 3.125" of the segment shall be milled down to 0.625" thick.
3. The lower, inserted section shall remain 0.75" thick. Slots measuring 8.2 mm wide x 24.5 mm deep shall be milled in this portion to receive tungsten carbide inserts and braze matrix.
4. The segment shall be cast to a 'horseshoe' design. The upper ears shall measure 2.55" wide (each with a 0.50" x 2.00" clip on the outside edges). The cutout measures shall be 6.13" x 2.8125" with 1" rads in the two lower corners

Tungsten Carbide Inserts

1. High shock resistant grade tungsten carbide.
2. Rooftop shape shall measure approximately 8.16mm thick, 24.25 mm tall and 25.9mm long.
3. Each insert shall weigh approximately 69 grams.
4. Each finished segment shall have 11 inserts (approximately 759 total grams of carbide insert material).
5. Tungsten carbide shall be 89% by physical weight – 100% virgin materials
6. Specific gravity shall be 14.35 to 14.6.
7. Hardness shall be 87.5 – 88.8 Rockwell A
8. Transverse rupture strength shall be 351,000 – 428,000 psi.

Braze

1. Inserts shall be brazed on all sides using Nickel/Silver braze
2. Shear strength shall be approximately 70,000 psi.
3. Maximum height difference between highest and lowest inserts shall be 1/32" in each 11.22" segment
4. Braze Composition Shall Be:

Copper/Silver	46.0-50.0%
Silicone	0.04-0.25%
Nickel	9.0-11.0%
Phosphorus	0.25%
Aluminum	0.01%
Lead	0.05%
Zinc	Remainder

Rubber Matrix

1. Typical Physical Properties Shall Be:

Ultimate Elongation	582%
100% Modulus	276 psi.
Tensile Strength	3113 psi.
Shore A Durometer	60 pts.
Tear Strength	341 psi.
Compression Set	26.5%
Brittleness	No cracks at -40C

Adapter Blade

Blade

1. Blade shall be ASTM A36 Structural Grade hot rolled flat steel. Blade size is 3/4" x 7" x 3 ft. or 4 ft. long.
2. Blade to have (2) sets of holes. The top set is an 8" on center punch pattern with holes drilled, counter-sunk, and square punched to accommodate a 5/8" plow bolt. The bottom set of holes has a 3-3-12 punch pattern, and are drilled thru at 11/16" diameter.
3. Dimensional tolerance between hole spacing is +/- 1/16" (non-accumulative) from center to center across the full length of blade.
4. The milled channel for carbide insert retention shall be positioned in the center of the blade edge.
5. Each blade will have weld stops positioned to enhance the performance of the blade assemblies.

Carbide Inserts

1. Inserts shall be trapezoidal in design, with the following dimensions:
 - a. Length: 1.0" nominal
 - b. Width: 0.36" min.
 - c. Height: 0.63" max.
 - d. Top angle: 25° with nose radius of 0.06"
2. Inserts to contain 89% tungsten (average by weight) and shall be of a grade containing 11% cobalt (average by weight).
3. Specific gravity (density) shall be between 14.35 and 14.60 gm/cc.
4. Hardness shall be Ra scale between 87.5 and 88.8, and have a minimum traverse rupture strength of 351,000 psi.

Brazing

1. Each blade shall contain approximately (1) 1" carbide insert for each 1" of blade length.
2. The carbide inserts shall be placed in-line within the milled channel.
3. The carbide inserts shall be brazed on all sides in contact with the blade using sound brazing practice, having no evidence of voids, and no use of shims or fillers.
4. Brazing material shall have a tensile strength of 70,000 psi.

Finished Product

1. Carbide tip points shall not exceed 1/32" between the highest and lowest point within any blade.
2. Finished blade will receive a complete powder coat (black) process for rust prevention. Front face of blade will be identified for proper installation.
3. Finished product will comply with standard blade manufacturing tolerances.
4. Manufacturer's literature shall be furnished as required.
5. Complete plow set-up will generally consist of a combination of (3) blade sections.
6. Complete nut and bolt sets shall be provided with adapter blades.

Curb Runner Guard

Steel

High impact, ASTM Grade A-36 Hot Rolled bar stock, 3/4" thick.

Bolt Holes

Drilled and square punched with countersink (3) places to accept 5/8" Plow Bolt flush with front mounting blade surface.

Rust Prevention

Chip and corrosion resistant Powder Coat (Black) on all surfaces. Bright Safety Orange paint over Powder Coat in carbide matrix area.

Curb Runner Casting

A-22 Cast Steel material with (0.9 lbs.) of carbide matrix.

Part Identification

Each curb runner guard has a label on the front mounting blade surface identifying the manufacturer and contact information.

Carbide Matrix Chemistry

<u>Material</u>	<u>Minimum Value</u>
Carbon	4.0
Silicon	0.5
Chrome	25.00
High Temp Carbide Formers	0.5
Nitride Formers	0.5
FE	Balance
Rc Hardness	55

Painting – All Flexible Plow Blade Equipment

All surfaces which are normally painted shall be painted with coatings suitable for severe exposure to road salt and abrasion.

**SNOW PLOW BLADE CUTTING EDGES
DETAILED SPECIFICATIONS
CONNECTICUT**

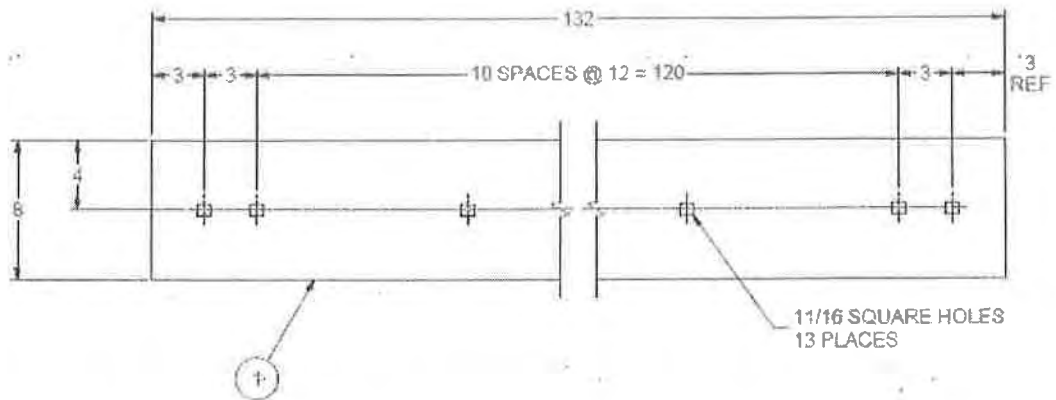
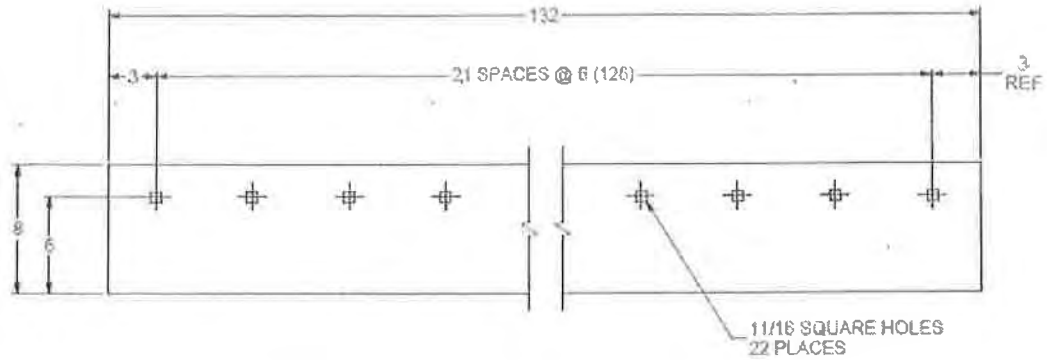

Above are the current plow punch patterns. The top drawing indicates 21 punches at 6 inch intervals. The bottom drawing indicates the standard AASHTO punch pattern. The bottom drawing is currently being with this punch.

8 inch top punch style plow blades made with C-1080 grade steel with a Brinell hardness range of 229-350

5/8 and 3/4 inch thick plow blades in the AASHTO punch pattern

**SNOW PLOW BLADE CUTTING EDGES
DETAILED SPECIFICATIONS
COLORADO**

**SP-CAR-V-97
TUNGSTEN CARBIDE INSERTS**

1. FUNCTIONAL REQUIREMENTS:

A. Have 3"-3"-12" etc 12"-3"-3" punching, 11/16" SQ. countersunk holes. Holes shall be spaced accurately with 12" center to center on a straight line and located within 1/16" of true position using both end holes as data points. The 1/16" shall be +/- non-accumulative. The first hole on left end is to be spaced 3" from the end. The right end of the blade is to be spaced the same as the left end. The gauge line of the hole is 1 1/2" from top edge of the blade to the center of the holes.

B. Must be flat with square edges.

C. Blade shall be constructed of carbon steel with Tungsten Carbide inserts. The Carbide inserts shall be trapezoidal in design, with the following dimensions:

Length 1" nominal

Height .750" +/- .005"

Top Angle 25-degree +/- 1 degree with nose radius of 1/16".

Insert hardness shall be 87 to 88.5 RA scale with a transverse rupture strength of at least 350,000 PSI.

D. All blades will be 3/4" thick.

E. Each blade may be coated with rust-preventative paint and completely dried prior to being bundled, or blades may be left unpainted.

F. The blades offered must be guaranteed against breakage. The vendor shall replace, at no cost, any blade that breaks during its useful life.

G. ALL BLADES MUST BE PACKAGED IN BUNDLES OF 10 EACH.

**SNOWPLOW BLADES
SP-V-97
THROUGH HARDENED HEAT TREATED**

1. FUNCTIONAL REQUIREMENTS:

A. Have 3"-3"-12" etc 12"-3"-3" punching, 11/16" SQ. countersunk holes. Holes shall be spaced accurately with 12" center to center on a straight line and located within 1/16" of true position using both end holes as data points. The 1/16" shall be +/- non-accumulative. The first hole on left end is to be spaced 3" from the end. The right end of

the blade is to be spaced the same as the left end. The gauge line of the hole is 1 1/2" from top edge of the blade to the center of the holes.

B. Must be flat with square edges.

C. Deleted wording here.

D. The blade shall be constructed of through hardened heat-treated alloy steel manufactured to a uniform range on the Rockwell C (RC) and Brinell scales. It shall be not less than RC 43 or more than RC 54. When Brinell tested it shall not be less than 400 or more than 528 using the 10mm carbide ball with 3000 kgf load.

E. All blades will be 3/4" thick.

F. Each blade may be coated with rust-preventative paint and completely dried prior to being bundled, or blades may be left unpainted.

G. The blades offered must be guaranteed against breakage. The vendor shall replace, at no cost, any blade that breaks during its useful life.

H. ALL BLADES MUST BE PACKAGED IN BUNDLES OF 10 EACH.

GRADER BLADES
GB-V-97
THROUGH HARDENED, HEAT TREATED

1. FUNCTIONAL REQUIREMENTS:

A. Have standard square highway punching, 1 1/16" and countersunk on cutting side. Holes shall be spaced accurately, 6" center to center on a straight line and located with 1/16" of true position using both end holes as data points. The 1/16" shall be +/- nonaccumulative. The first hole on left end is to be spaced 3" from the end with the 2nd hole 3" from the first hole. The right end is to be spaced the same as the left end. Holes to be punched 2" from top of the blade to center of holes.

B. Must be curved and double beveled.

C. The cutting edge and moldboard edge shall have approximately a one-inch bevel.

D. The blade shall be constructed of through hardened heat-treated alloy steel manufactured to a uniform range on the Rockwell C (RC) and Brinell scales. It shall be not less than RC 43 or more than RC 53. When Brinell tested it shall not be less than 400 or more than 528 using the 10mm carbide ball with 3000 kgf load.

E. All grader blades will be 5/8" thick.

F. Each blade may be coated with rust-preventative paint and completely dried prior to being bundled, or blades may be left unpainted.

G. The grader blades offered must be guaranteed against breakage. The vendor shall replace, at no cost, any blade that breaks during its useful life.

DELIVERY REQUIREMENTS:

Materials must be delivered to storerooms statewide as indicated on the purchase order.

All blades to be packaged in quantities of 10 each

Vendor is to deliver entire order, no partials accepted.

Delivery of items in a timely manner is critical. Therefore, the expected delivery date or delivery time period after receipt of order (ARO) is to be 30 days.

**SNOW PLOW BLADE CUTTING EDGES
DETAILED SPECIFICATIONS
NEW YORK**

**Item# 8 - SECTION CENTER - CARBIDE INSERT BLADE
3/4 X 6 X 28 IN.**

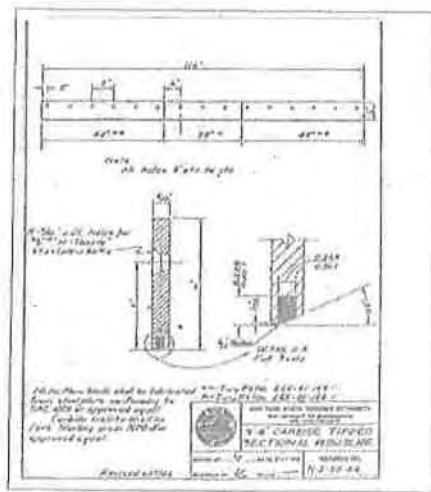

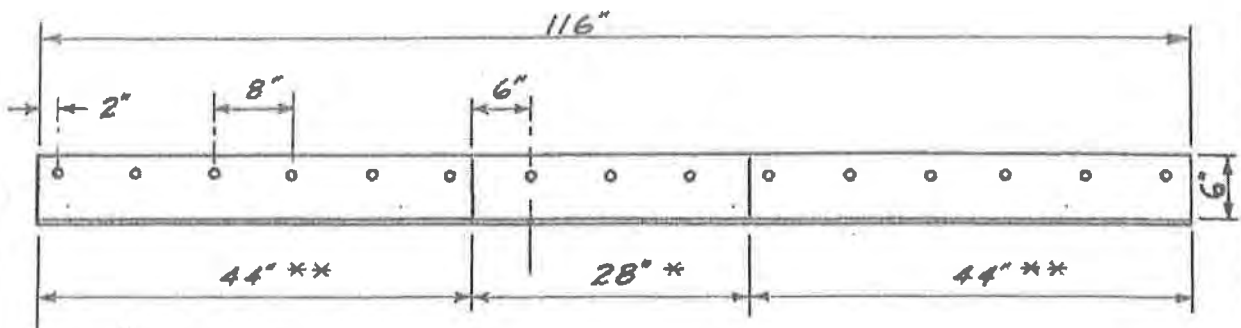

Note:
All holes 8" ctr. to ctr.

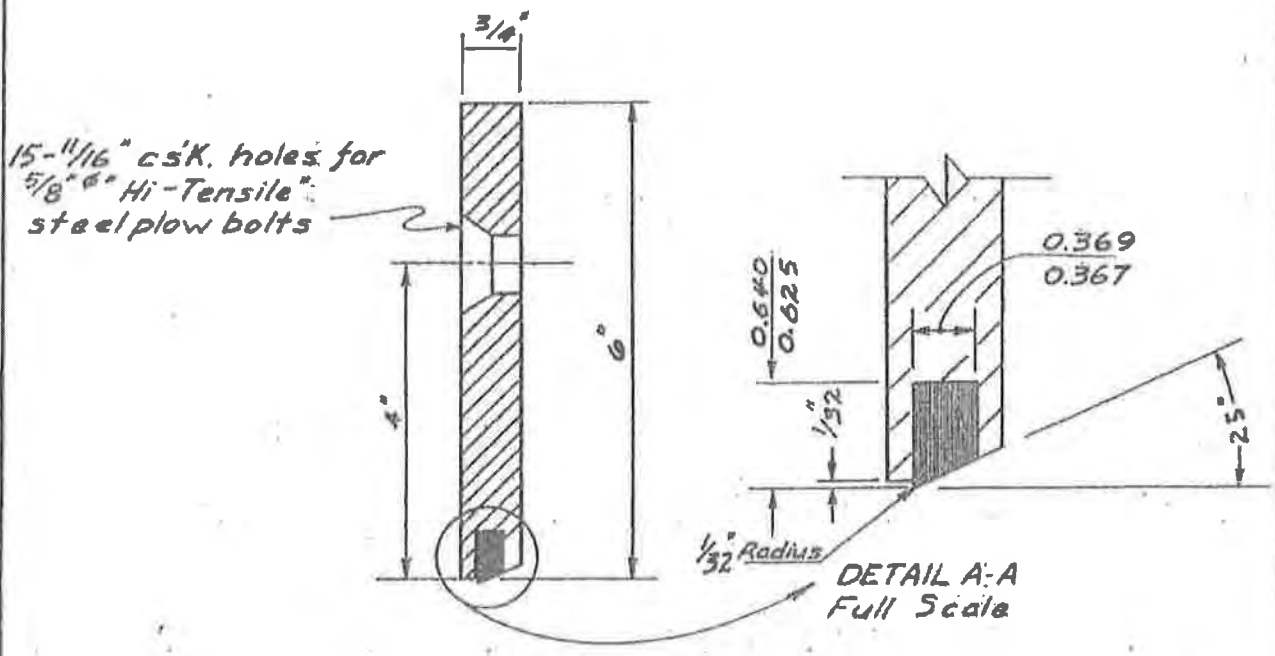

15-1/16" c.s.K. holes for
5/8" Hi-Tensile
steel plow bolts

Note: Plow blade shall be fabricated from steel plate conforming to SAE 1020 or approved equal. Carbide inserts shall be Firth Sterling grade MPD-II or approved equal.

** - Twy Pt. No. 265-01-145 ✓
* - Twy Pt. No. 265-01-144 ✓

Revised 6/17/68

	NEW YORK STATE THRUWAY AUTHORITY	
	DEPARTMENT OF ENGINEERING	
	NEW YORK STATE THRUWAY AUTHORITY	
	9'8" CARBIDE TIPPED	
SECTIONAL PLOW BLADE		DRAWING NO.
DRAWN BY .. LS	DATE 6/14/66	DRAWING NO. 11-2-50-A0
CHECKED BY .. LC	SCALE: N.T.S.	11-2-50 A0

10	SECTION 5-HOLE CARBIDE INSERT WING
	BLADE 3/4 X 6 X 42
11	SECTION 5-HOLE CARBIDE INSERT WING
	BLADE 3/4 X 6 X 40 IN
12	SECTION 6-HOLE CARBIDE INSERT WING
	BLADE 3/4 X 6 X 46 IN

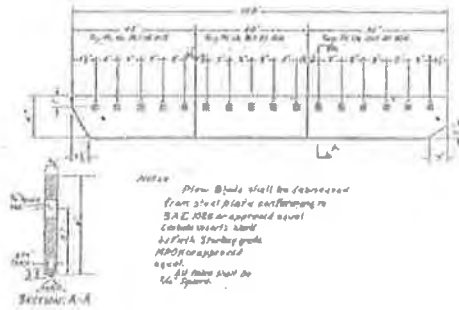

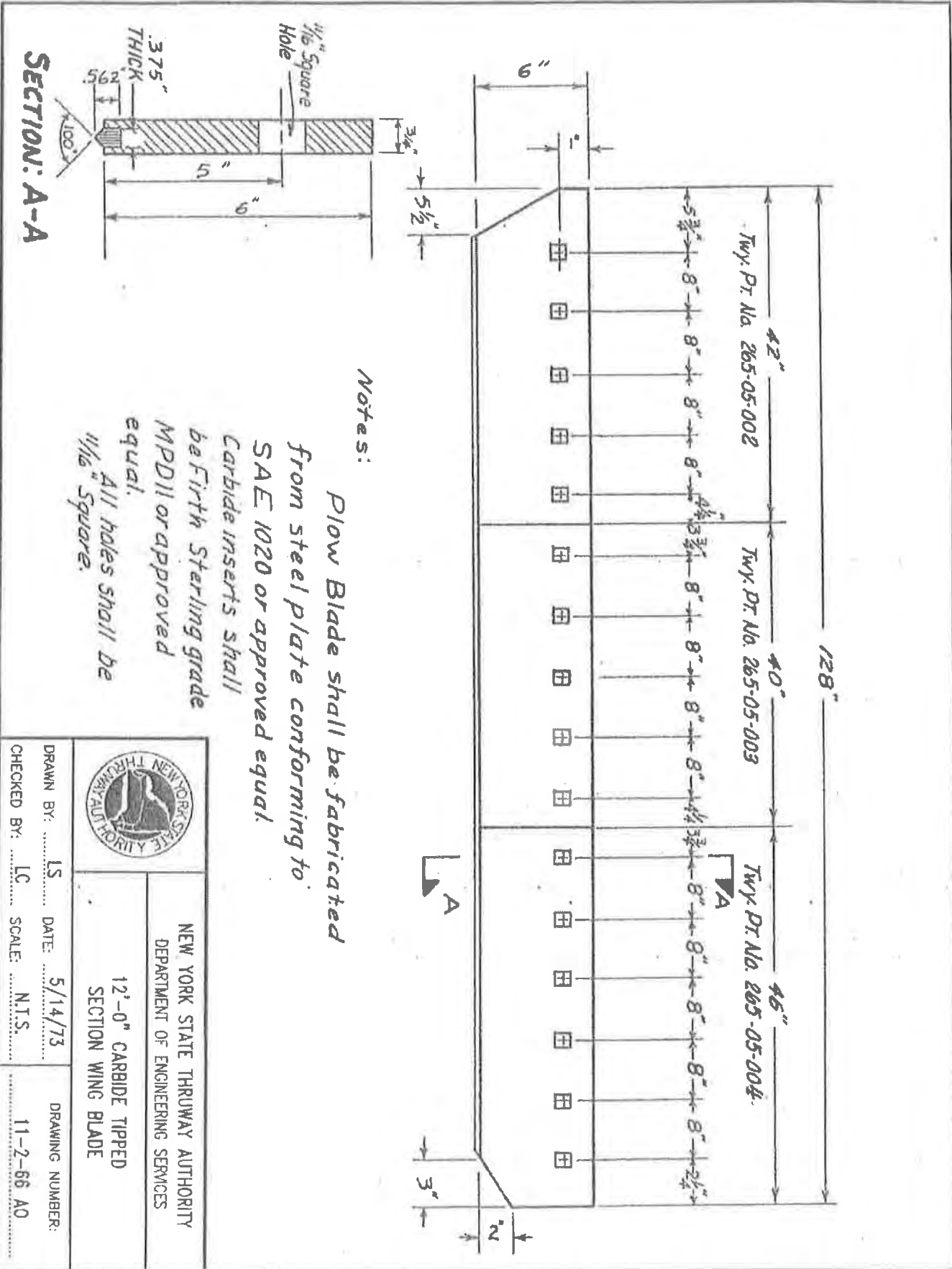

SECTION: A-A

Notes:
 Plow Blade shall be fabricated from steel plate conforming to SAE 1020 or approved equal. Carbide inserts shall be Firth Sterling grade MPD11 or approved equal. All holes shall be 1/16" Square.

	NEW YORK STATE THRUWAY AUTHORITY DEPARTMENT OF ENGINEERING SERVICES	
	12'-0" CARBIDE TIPPED SECTION WING BLADE	
DRAWN BY: IS CHECKED BY: LC	DATE: 5/14/73 SCALE: N.T.S.	DRAWING NUMBER: 11-2-66 A0

**Item # 14 – Section End Carbide
Insert Blade $\frac{3}{4} \times 6 / 38$ In. 5 - Hold**

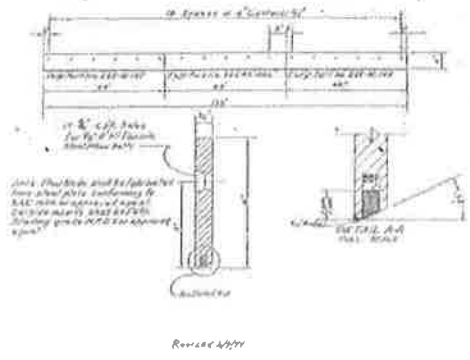

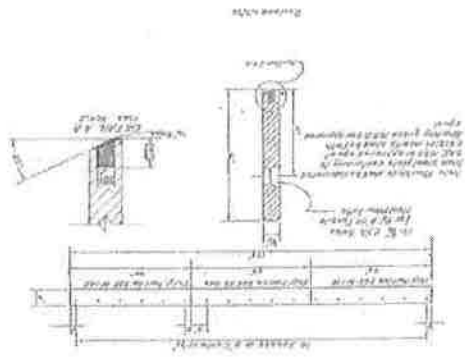

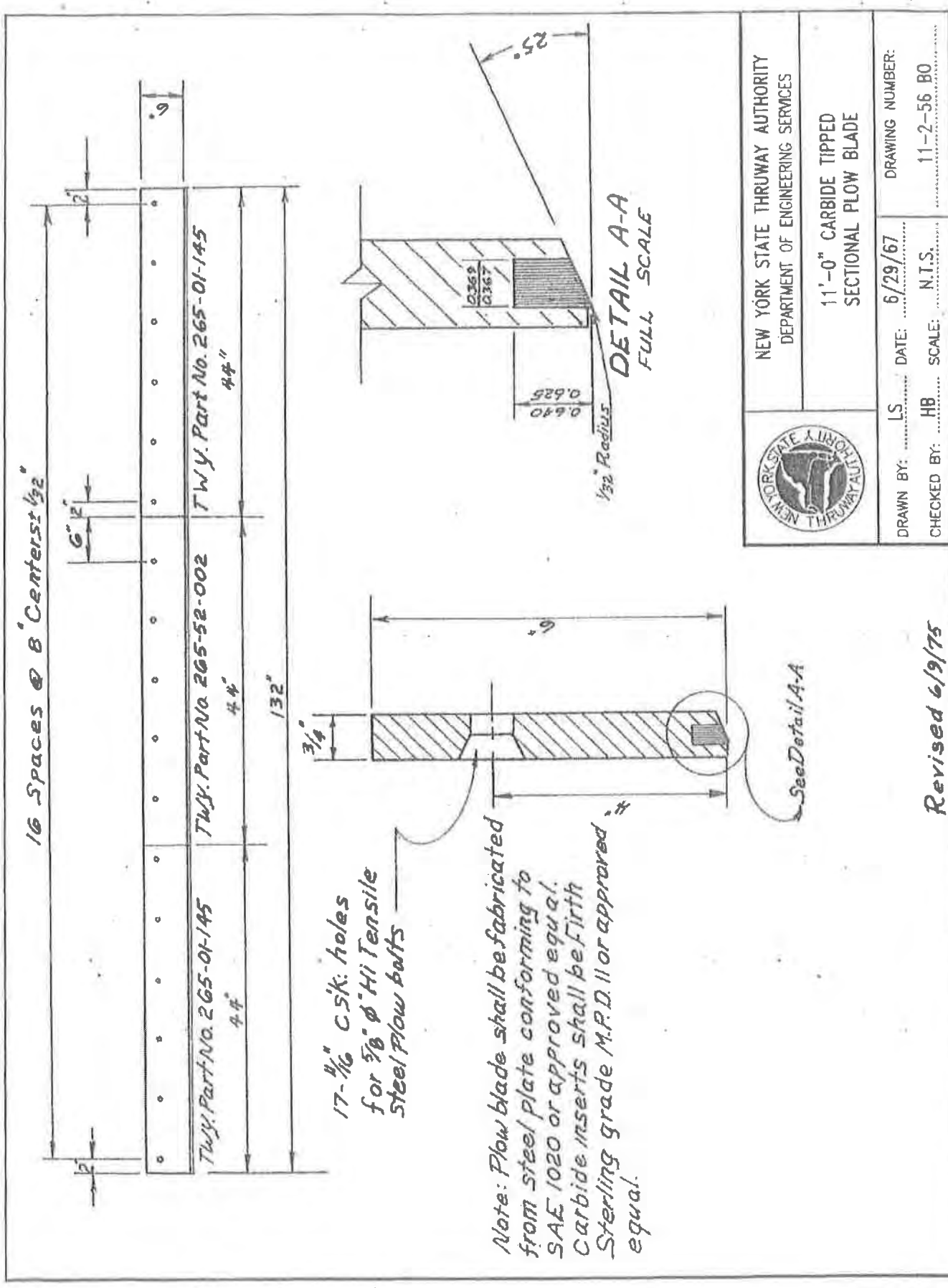

		NEW YORK STATE THRUWAY AUTHORITY DEPARTMENT OF ENGINEERING SERVICES	
11'-0" CARBIDE TIPPED SECTIONAL FLOW BLADE			
DRAWN BY: LS	DATE: 6/29/67	DRAWING NUMBER:	
CHECKED BY: HB	SCALE: N.T.S.	11-2-56 80	

Revised 6/9/75

14 SPACES AT 8" CENTERS ± 1/32"

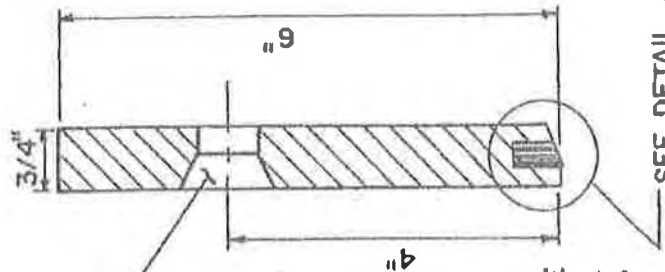
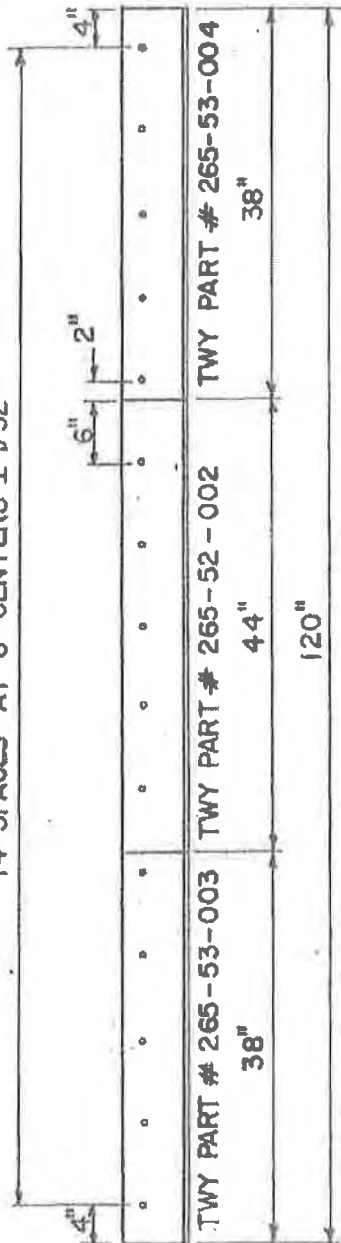

15 EA. 1/16" CS'K HOLES FOR
5/8" Ø HI-TENSILE STEEL
PLOW BOLTS

NOTE:

FLOW BLADE SHALL BE FABRICATED FROM STEEL PLATE CONFORMING TO SAE 1020 OR APPROVED EQUAL. CARBIDE INSERTS SHALL BE FIRTH STERLING GRADE M.P.D.-11 OR APPROVED EQUAL.

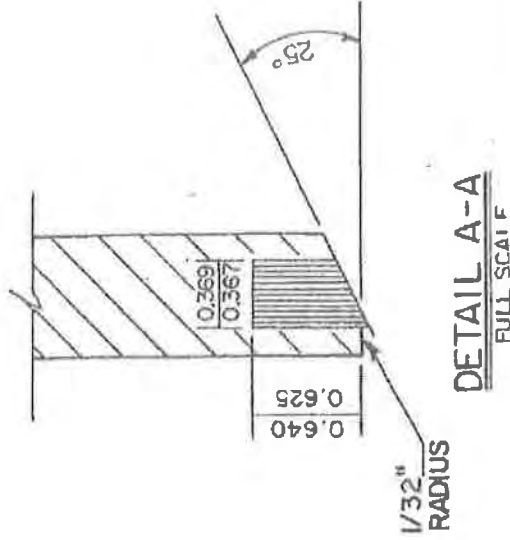

NEW YORK STATE THRUWAY AUTHORITY
DEPARTMENT OF ENGINEERING SERVICES

10'-0" CARBIDE TIPPED
SECTIONAL PLOW BLADE

14 SECTION END CARBIDE
INSERT BLADE 3/4 X 6 X 38 IN.-5-HOLE

DRAWN BY: PAK DATE: 2/13/94 DRAWING NUMBER:
CHECKED BY: LC SCALE: N.T.S. 11-2-80 AT

Item # 16	EDGE WING 12 FT 212112
--------------	------------------------

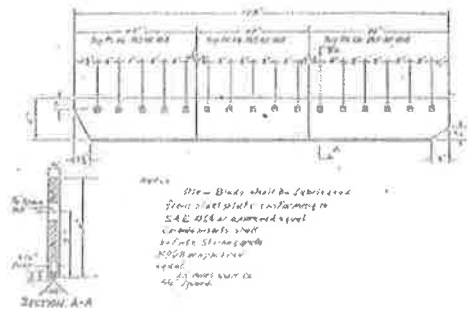



	NEW YORK STATE THRUWAY AUTHORITY DEPARTMENT OF ENGINEERING SERVICES	
	DRAWING TITLE	
DRAWN BY: DD	DATE: DATE	DRAWING NUMBER:
CHECKED BY: DD	SCALE: N.T.S.	1-1-241AT

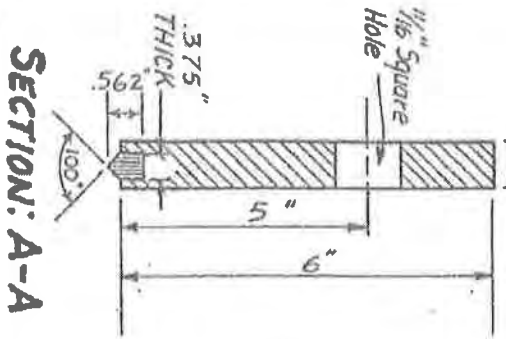
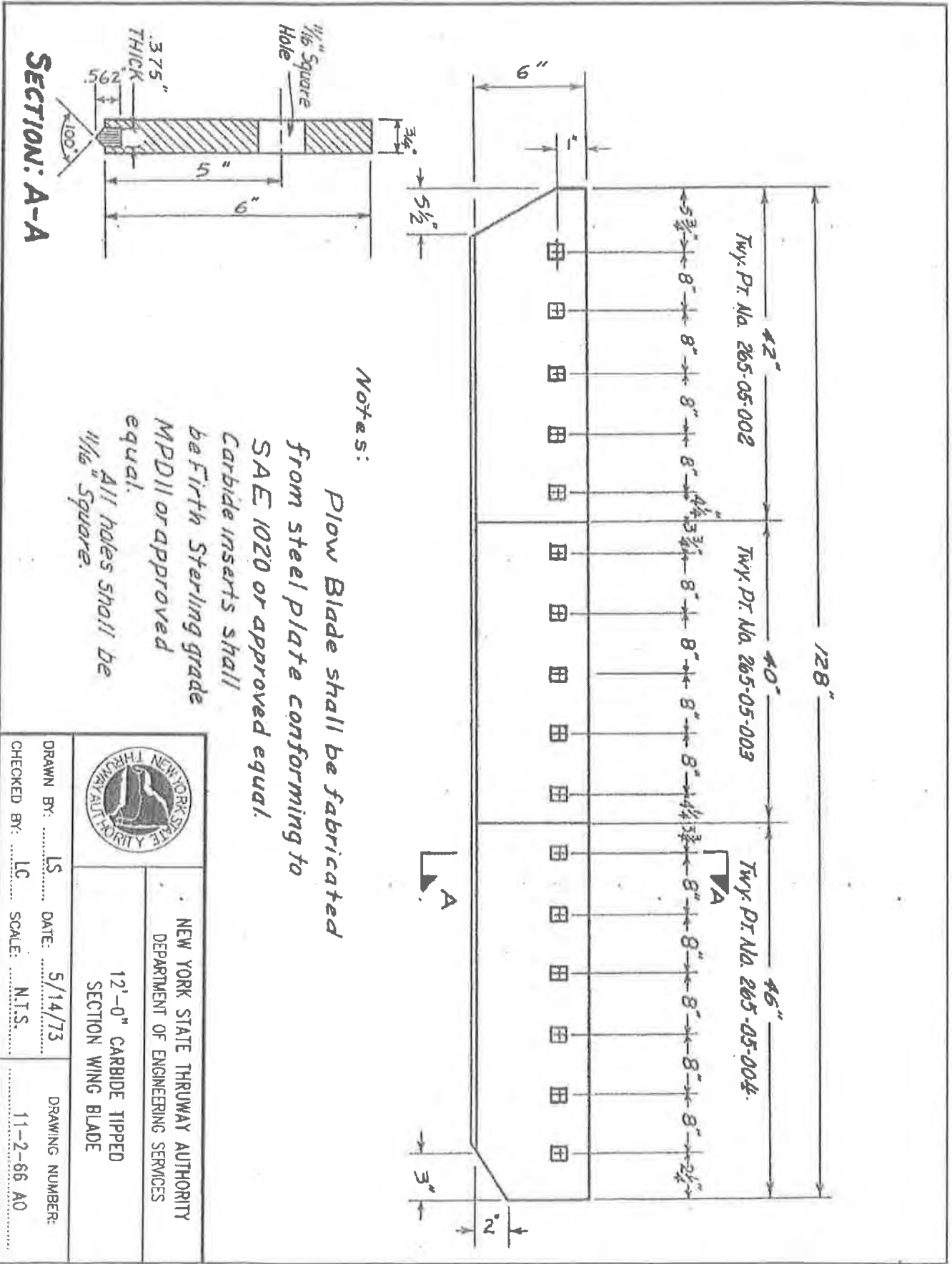

SECTION: A-A

Notes:
 Plow Blade shall be fabricated from steel plate conforming to SAE 1020 or approved equal. Carbide inserts shall be Firth Sterling grade MPD11 or approved equal. All holes shall be 5/16" Square.

	NEW YORK STATE THRUWAY AUTHORITY DEPARTMENT OF ENGINEERING SERVICES	
	12'-0" CARBIDE TIPPED SECTION WING BLADE	
DRAWN BY: LS CHECKED BY: LC	DATE: 5/14/73 SCALE: N.T.S.	DRAWING NUMBER: 11-2-66 A0

**SNOW PLOW BLADE CUTTING EDGES
OTHER BLADE SYSTEMS NOT INCLUDED IN THE ATTACHED
SPECIFICATIONS**

**BIDDERS MAY OFFER FOR CONSIDERATION, OTHER PLOW BLADES AND
BLADE SYSTEMS THAT ARE NOT OTHERWISE INCLUDED IN THE ATTACHED
SPECIFICATIONS.**

**BIDDERS MUST INCLUDE COMPLETE DETAILED SPECIFICATIONS AND
DESCRIPTIONS FOR ANY BLADE OR BLADE SYSTEM OFFERED.**

**SNOW PLOW BLADE CUTTING EDGES
DELIVERY LOCATIONS
VERMONT**

AGENCY OF TRANSPORTATION
MAINTENANCE & AVIATION DIVISION
DISTRICT & CENTRAL GARAGE
ADDRESSES

DISTRICT 1: 359 BOWEN RD.
BENNINGTON, VT 05201

DISTRICT 2: 870 US RTE. 5
N. BRATTLEBORO, VT 05304

DISTRICT 3: 122 STATE PLACE
RUTLAND, VERMONT
05701

DISTRICT 4: 221 BESWICK DR.
WHITE RIVER JCT., VT 05001

DISTRICT 5: 5 BARNES RD.
COLCHESTER, VT 05452

DISTRICT 6: 186 INDUSTRIAL LANE RD.-
BERLIN BARRE, VT 05641

DISTRICT 7: 1068 US RTE. 5, SUITE 2
ST. JOHNSBURY, VT 05819

DISTRICT 8: 680 LOWER NEWTON RD.
ST. ALBANS, VT 05478

DISTRICT 9: 4611 US RTE. 5
NEWPORT, VT 05855

TRAFFIC SHOP/CENTRAL GARAGE: BARRE-MONTPELIER RD.
BARRE, VT
05641

**SNOW PLOW BLADE CUTTING EDGES
DELIVERY LOCATIONS
IDAHO**

District 1 Yard
600 West Prairie
Coeur d'Alene, ID 83814

District 2 Yard
2600 Frontage Road
Lewiston, ID 83501-0837

District 3 Yard
8150 Chinden Boulevard
Boise, ID 83714

District 4 Yard
216 Date Street
Shoshone, ID 83352

District 5 Yard
5151 South 5th

Pocatello, Idaho 83204

District 6 Yard
206 N. Yellowstone

Rigby, Idaho.83442

**SNOW PLOW BLADE CUTTING EDGES
DELIVERY LOCATIONS
MASSACHUSETTS**

MassDOT Central Warehouse
668 South Ave
Weston, MA 02493

**SNOW PLOW BLADE CUTTING EDGES
DELIVERY LOCATIONS
ALASKA**

FOB Points for Alaska:

1. Fairbanks: 2301 Peger Road, Fairbanks AK 99709
2. Seattle: Dockside Seattle
3. Anchorage: 5300 Tudor Rd., Anchorage, AK 99507
4. Anchorage Int'l Airport: Field Maint. 5740 DeHavilland Dr, Anchorage, AK 99502
5. Palmer: 289 Inner Springs Loop, Palmer, AK 99645

Seattle would be the out-of-state CDPP with the following language:

CONTRACT DESIGNATED PRICING POINTS:

- 1) The contract(s) resulting from this solicitation will provide pricing for items delivered to in-state Alaska (three destinations; Anchorage, Palmer and Fairbanks, Alaska) and Dockside Seattle, Washington. These two areas are known as the Contract Designated Pricing Points (CDPP). CDPP's are further defined as:
 - a) the CDPP of Anchorage, Alaska is defined as prepared for further shipment and delivered at the DOT/PF facility, or the receiving yard of the state's specified carrier (water, surface or air carrier) in Anchorage, Alaska;
 - b) *the CDPP of Fairbanks, Alaska is defined as prepared for further shipment and delivered at the Department of Transportation & Public Facilities Maintenance Station Yard at 2301 Peger Road, Fairbanks, Alaska, or the receiving yard of the state's specified carrier (water, surface or air carrier) in Fairbanks, Alaska;*
 - c) *the CDPP of Palmer, Alaska is defined as prepared for further shipment and delivered at the Department of Transportation & Public Facilities Maintenance Station Yard at 289 Inner Springs Loop, Palmer, AK 99645, or the receiving yard of the state's specified carrier (surface or air carrier) in Palmer, Alaska*
 - d) the CDPP of Dockside, Seattle, Washington is defined as prepared for further shipment and delivered at the receiving yard of the state's specified water carrier in Seattle, Washington.
- 2) Some orders will require additional shipping by the Contractor from the CDPP's to other locations within the State of Alaska. In such cases, the Contractor must ship to the final destination and prepay any additional shipping from the designated CDPP. **The Contractor shall invoice the additional shipping costs as a separate item and provide actual cost receipts with the invoice.** In all instances where additional

shipping occurs, the State reserves the right to determine the method of shipment based on need. Following are examples of shipping and delivery to the final destination other than the CDPP's:

- a) An order with a final destination of Wasilla, Alaska will be ordered from the Contractor awarded the contract for that Lot and priced for the CDPP of Palmer, Alaska. The Contractor will ship and deliver the items to the Wasilla DOT/PF facility noted on the order. The State will be invoiced the price of the items listed for the CDPP of Palmer, Alaska, plus the additional shipping from Anchorage to the Palmer DOT/PF facility as a separate item. **The Contractor must provide with their invoice, actual cost receipts for any additional shipping charges beyond the CDPP.**
- b) An order with a final destination of Tok, Alaska, will be ordered from the Contractor awarded the contract for that Lot and priced for the CDPP of Fairbanks, Alaska. The Contractor will ship and deliver the items to the Tok DOT/PF facility noted on the order. The State will be invoiced the price of the items listed for the CDPP of Fairbanks, Alaska, plus the shipping from Fairbanks to the Tok DOT/PF facility as a separate item. **The Contractor must provide with their invoice, actual cost receipts for any additional shipping charges beyond the CDPP.**
- c) An order with a final destination of Nome, Alaska will be ordered from the Contractor awarded the contract for that Lot and priced for the CDPP of Dockside Seattle Washington. The Contractor will ship and deliver the items to the Nome DOT/PF facility noted on the order. The State will be invoiced for the price of the items listed for the CDPP of Dockside Seattle, Washington, plus the shipping from Dockside Seattle to the Nome DOT/PF facility as a separate item. **The Contractor must provide with their invoice, actual cost receipts for any additional shipping charges beyond the CDPP.**
- d) An order with a final destination of Kodiak, Alaska shall be ordered from the Contractor awarded the contract for that Lot and at the State's discretion, priced for the CDPP of Anchorage, Alaska OR from the CDPP Dockside Seattle, Washington. The Contractor will deliver the items to the final destination (Kodiak DOT/PF facility) noted on the order and invoice for the price of the items listed for the CDPP location selected by the State. **The additional shipping costs from the designated CDPP to the final destination shall be invoiced as a separate item. The Contractor must provide with their invoice, actual cost receipts for any additional shipping charges beyond the CDPP.**

F.O.B. POINT: The F.O.B. point for all items purchased under this contract is the final destination anywhere within the State of Alaska. Ownership of and title to the ordered items remains with the contractor until the items have been delivered to their final destination and are accepted by the State.

The State reserves the right to select the Contract Destination Pricing Points (CDPP) when placing the order. The cost of shipping and delivery to the CDPP is to be included in the bid price. The cost of shipping and delivery for orders beyond a CDPP will be handled as follows:

The contractor will prepay the shipping and delivery charges to any destination named by the State in its order. The contractor will charge-back those actual shipping and delivery charges to the State as a separate item on the State's invoice. In all instances where additional shipping occurs, the State reserves the right to determine the method of shipment based on cost or need.

**SNOW PLOW BLADE CUTTING EDGES
DELIVERY LOCATIONS
UTAH**

TBD

**SNOW PLOW BLADE CUTTING EDGES
DELIVERY LOCATIONS
NEW HAMPSHIRE**

Highway Maintenance Districts

DISTRICT	DELIVERY LOCATION / CONTACT PERSON	TELEPHONE
District 1	Brian Schutt, District One Engineer Attn: John Ross Jr. NHDOT Patrol Shed 107 W - Whitefield 24 Foster Drive Whitefield, NH 03598	603-788-4641 603-631-9151 (Cell)
District 2	Alan G. Hanscom, District Two Engineer c/o Dennis Ford, Maintenance Supervisor Exit 16, I-89, 8 Eastman Hill Road Enfield, NH 03748	603-448-2654
District 3	Mark Morrill, District Three Engineer c/o Andrew Dame, Warehouse Supervisor District Three Patrol Shed Warehouse 310 710 Whittier Highway (Route 25) Moultonborough NH 03254	603-524-6667 603-419-0810
District 4	John Kallfelz, District Four Engineer c/o Robert Hebert, Warehouse Supervisor 19 Base Hill Road Swanzey, NH 03446-3401	603-352-6614 603)419-0406 (Cell)
District 5	Rich Radwanski, District Five Engineer c/o Amy Mansfield, Warehouse Supervisor District Five Patrol Shed 505 670 Route 3A Bow, NH 03304	603-666-3336
District 6	Douglas DePorter, District Six Engineer c/o Michael Lavoie or Ken Mailhot, Maintenance Supervisors District Six Patrol Shed 608 Route 125 Epping (adjacent to Motor Vehicle/State Police) Durham, NH 03824	603-868-1133
Bureau of Turnpikes	Dix Bailey, Maintenance Supervisor NHDOT Bureau of Turnpikes 36 Hackett Hill Road Hooksett NH 03106 Exit 11, off I-93	603-485-3806

**SNOW PLOW BLADE CUTTING EDGES
DELIVERY LOCATIONS
MAINE**

Region 1 Scarborough Fleet Service, 61 Pleasant Hill Road, Scarborough, Maine 04070

Region 2 Augusta Fleet Service, Wade Street Entrance, Augusta, Maine 04333

Region 3 Dixfield Fleet Service, 547 Main St., Dixfield Maine 04224

Region 4 Hancock Bridge Lot, 327 Thorsen Road, Hancock Maine 04640

Region 5 Caribou Fleet Service, 145 Bennett Dr., Caribou Maine 04736

Region 5 Houlton Fleet Service, 159 Bangor Street, Houlton, Maine 04730

**SNOW PLOW BLADE CUTTING EDGES
DELIVERY LOCATIONS
CONNECTICUT**

DOT Warehouse – 660 Brook Street Rocky Hill, Connecticut 06067

**SNOW PLOW BLADE CUTTING EDGES
DELIVERY LOCATIONS
COLORADO**

1001 – Aurora -- 18500 E. Colfax, Aurora, CO 80011

Thad Fraedrich (303) 365-7122 (1-7122)
Aurora Fax: (303) 340-3710 (1-3710)

1002 – CDOT Eisenhower Tunnel –

Ship to: Whse 13, East Portal, 8mile east on I-70, Silverthorne CO 80498
Invoice to: PO Box 397, Idaho Springs, CO 80452-0397

Vacant (303) 512-5745 (1-5745)
Brook Howard (303) 512-5732 (1-5732)
Richard Rangel (303) 512-5746 (1-5746)
Tunnel Fax (303) 512-5797 (1-5797)

2001 – Pueblo -- 905 Erie Ave, Pueblo, CO 81001

Kyle Carver (719) 546-5423 (2-5423)
Pueblo Fax (719) 546-5484 (2-5484)

3001 – Grand Junction – 606 9th St., Grand Junction, CO 81501

Mario Ramos (970) 683-6322 (3-6322)
Grand Junction Fax (970) 683-6342 (3-6342)

3002 – Craig – 260 Ranney St, Craig, CO 81625

Dennis Sanchez (970) 826-5163 (3-5163)
Sandy Shultz (970) 826-5172 (3-5172)
Craig Fax (970) 826-5182 (3-5182)

4001 - Greeley -- 1420 2nd St., Greeley, CO 80631

Kim Cornwell (970) 350-2125 (4-2125)
Greeley Fax (970) 350-2199 (4-2199)

5001 – Alamosa – 1205 West Avenue, Alamosa, CO 81101

Gary Hagaman (719) 587-6420 (5-6420)
Alamosa Fax (719) 587 6424 (5-6424)

5002 – Durango -- 20581 Hwy 160 West, Durango, CO 81301

Dean Stanton (970) 385-1657 (5-1657)
Durango Fax (970) 385-1669 (5-1669)

**SNOW PLOW BLADE CUTTING EDGES
DELIVERY LOCATIONS
NEW YORK**

21 Ninth St,
Waterford, NY 12188

10 Harbor Lock Road West Utica, NY 13502

5450 South Bay Rd
No. Syracuse, NY 13212

2797 Clover St.
Pittsford, NY 14534

4717 Southwestern Blvd. Hamburg, NY 14075

7000 County Route 70A Hornell, NY 14843

Box 22422, Route 342 Watertown, NY 13601

272-278 Violet Avenue Poughkeepsie, NY 12601

241 Colesville Road Binghamton, NY 13904

375 North Carleton Ave, Central Islip, NY 11722

New York Division

Interchange 12

201 North Route 303

West Nyack, NY 10994

Albany Division

Interchange 23

Route 9W

Albany, NY 12209

Syracuse Division

Interchange 35

6517 Old Thompson Road

East Syracuse, NY 13057

Buffalo Division

Interchange 52

1870 Walden Avenue

Cheektowaga, NY 14225