

STATE OF NEBRASKA CONTRACT AMENDMENT

State Purchasing Bureau
1526 K Street, Suite 130
Lincoln, Nebraska 68508

Telephone: (402) 471-6500
Fax: (402) 471-2089

CONTRACT NUMBER
14845 OC

PAGE 1 of 2	ORDER DATE 04/28/20
BUSINESS UNIT 33130171	BUYER CHRISTIE KELLY (AS)
VENDOR NUMBER: 2359922	
VENDOR ADDRESS: SEALITE USA LLC 61 BUSINESS PARK DR TILTON NH 03276-5821	

THE CONTRACT PERIOD IS:

SEPTEMBER 27, 2019 THROUGH SEPTEMBER 26, 2020

THIS CONTRACT HAS BEEN AMENDED PER THE FOLLOWING INFORMATION:

NO ACTION ON THE PART OF THE CONTRACTOR NEEDS TO BE TAKEN AT THIS TIME. ORDERS FOR THE MATERIALS AND/OR SERVICES WILL BE MADE AS NEEDED BY THE VARIOUS AGENCIES OF THE STATE.

THIS CONTRACT IS NOT AN EXCLUSIVE CONTRACT TO FURNISH THE MATERIALS AND/OR SERVICES SHOWN BELOW, AND DOES NOT PRECLUDE THE PURCHASE OF SIMILAR MATERIALS AND/OR SERVICES FROM OTHER SOURCES.

THE STATE RESERVES THE RIGHT TO EXTEND THE PERIOD OF THIS CONTRACT BEYOND THE TERMINATION DATE WHEN MUTUALLY AGREEABLE TO THE CONTRACTOR AND THE STATE OF NEBRASKA.

Original/Bid Document 5628 OF

Contract to supply and deliver CAN BUOYS to the State of Nebraska as per the attached specifications for the contract period September 27, 2019 through September 26, 2020. The contract may be renewed for two (2) additional one (1) year periods when mutually agreeable to the vendor and the State of Nebraska.

Vendor Contact: Jason Wernig
Phone: 603-556-7144
Fax: 603-737-1320
E-Mail: j.wernig@sealite.com

This is the second renewal of the contract as amended. (9/11/19 sc)

Amendment two (2) as attached (mh 4/28/20)

Line	Description	Estimated Quantity	Unit of Measure	Unit Price
1	CAN BUOY 12X51 Make: Sealite Model: B1452	200.0000	EA	214.0000
2	REGULATORY BUOYS EXCLUDING THE SEALITE B1452 BUOY Sealite 30% discount from list pricing	5,000.0000	\$	1.0000
3	FLOAT COLLAR CANS 30% discount from list pricing.	5,000.0000	\$	1.0000

Christina L. Kelly 05.06.20
BUYER
[Signature]
MATERIEL ADMINISTRATOR

STATE OF NEBRASKA CONTRACT AMENDMENT

State Purchasing Bureau
1526 K Street, Suite 130
Lincoln, Nebraska 68508

Telephone: (402) 471-6500
Fax: (402) 471-2089

CONTRACT NUMBER
14845 OC

PAGE 2 of 2		ORDER DATE 04/28/20	
BUSINESS UNIT 33130171		BUYER CHRISTIE KELLY (AS)	
VENDOR NUMBER: 2359922			

Line	Description	Estimated Quantity	Unit of Measure	Unit Price
4	GREEN CHANNEL MARKERS 30% discount from list pricing	5,000.0000	\$	1.0000
5	RED CHANNEL MARKERS 30% discount from list pricing	5,000.0000	\$	1.0000
6	HARDWARE INCLUDES CABLE CHAIN AND FASTERS 30% discount from list pricing	5,000.0000	\$	1.0000
7	RESTORATION MATERIALS 30% discount from list pricing	5,000.0000	\$	1.0000

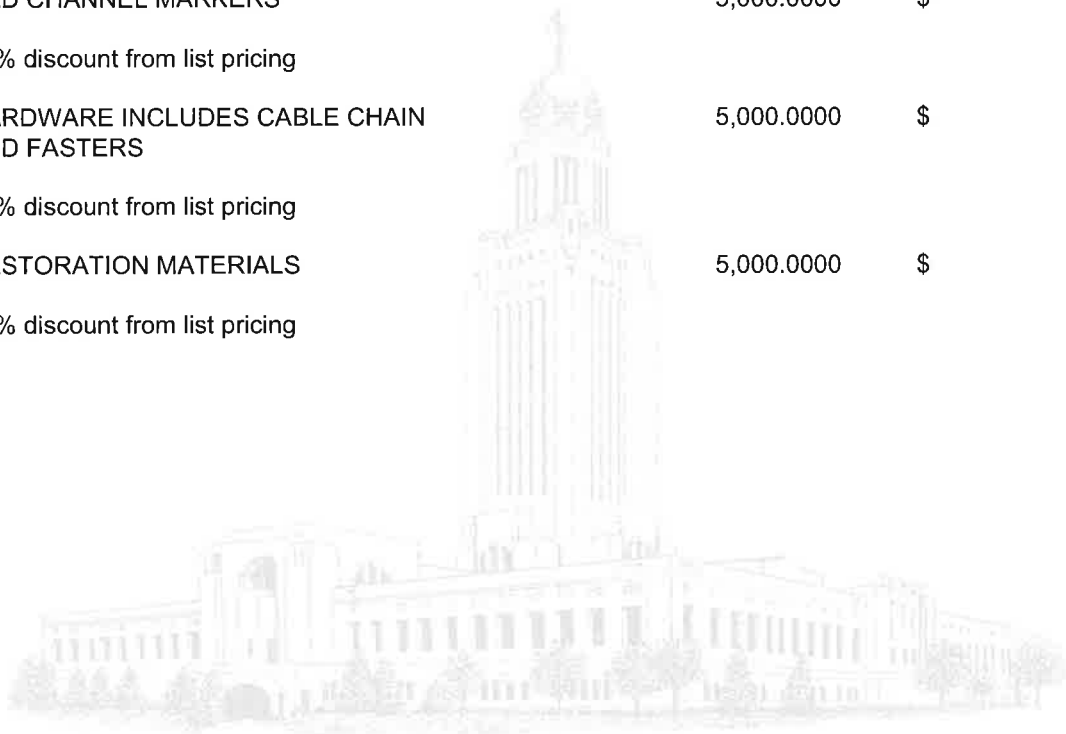

CLK

BUYER INITIALS

R43500|NISM0001|NISM0001 20150901

AMENDMENT TWO
Contract 14845 OC
Can Buoys
for the State of Nebraska
Between
The State of Nebraska and Sealite USA LLC

This Amendment (the "Amendment") is made by the State of Nebraska and Sealite USA LLC, parties to Contract 14845 OC (the "Contract"), and upon mutual agreement and other valuable consideration, the parties agree to and hereby amend the contract upon Execution by both parties as follows:

1. Vendor Contact information is hereby superseded and replaced by:

Vendor Contact: Jason Wernig
Phone: 603-556-7144
Fax: 603-737-1320
Email: j.wernig@sealite.com

This amendment and any attachments hereto will become part of the Contract. Except as set forth in this Amendment, the Contract is unaffected and shall continue in full force and effect in accordance with its terms. If there is conflict between this amendment and the Contract or any earlier amendment, the terms of this amendment will prevail.

IN WITNESS WHEREOF, the parties have executed this Amendment as of the date of execution by both parties below.

State of Nebraska

By:  _____

Name: Doug Carlson

Title: Materiel Administrator

Date: 5/14/2020

Contractor: Sealite USA LLC

By:  _____

Name: Jason Wernig

Title: Account Manager – Marine North America

Date: April 23, 2020

STATE OF NEBRASKA CONTRACT AWARD

State Purchasing Bureau
1526 K Street, Suite 130
Lincoln, Nebraska 68508

Telephone: (402) 471-6500
Fax: (402) 471-2089

CONTRACT NUMBER
14845 OC

PAGE 1 of 2	ORDER DATE 09/11/19
BUSINESS UNIT 33130171	BUYER CHRISTIE KELLY (AS)
VENDOR NUMBER: 2359922	
VENDOR ADDRESS: SEALITE USA LLC 61 BUSINESS PARK DR TILTON NH 03276-5821	

AN AWARD HAS BEEN MADE TO THE CONTRACTOR NAMED ABOVE FOR THE FURNISHING OF MATERIALS AND/OR SERVICES AS LISTED BELOW FOR THE PERIOD:

SEPTEMBER 27, 2019 THROUGH SEPTEMBER 26, 2020

NO ACTION ON THE PART OF THE CONTRACTOR NEEDS TO BE TAKEN AT THIS TIME. ORDERS FOR THE MATERIALS AND/OR SERVICES WILL BE MADE AS NEEDED BY THE VARIOUS AGENCIES OF THE STATE.

THIS CONTRACT IS NOT AN EXCLUSIVE CONTRACT TO FURNISH THE MATERIALS AND/OR SERVICES SHOWN BELOW, AND DOES NOT PRECLUDE THE PURCHASE OF SIMILAR MATERIALS AND/OR SERVICES FROM OTHER SOURCES.

THE STATE RESERVES THE RIGHT TO EXTEND THE PERIOD OF THIS CONTRACT BEYOND THE TERMINATION DATE WHEN MUTUALLY AGREEABLE TO THE CONTRACTOR AND THE STATE OF NEBRASKA.

Original/Bid Document 5628 OF

Contract to supply and deliver CAN BUOYS to the State of Nebraska as per the attached specifications for the contract period September 27, 2019 through September 26, 2020. The contract may be renewed for two (2) additional one (1) year periods when mutually agreeable to the vendor and the State of Nebraska.

Vendor Contact: Joseph Richter, Business Development Manager USA
Phone: 603-737-1321
Fax: 603-737-1320
E-Mail: j.richter@sealite.com

This is the second renewal of the contract as amended. (9/11/19 sc)

Line	Description	Estimated Quantity	Unit of Measure	Unit Price
1	CAN BUOY 12X51 Make: Sealite Model: B1452	200.0000	EA	214.0000
2	REGULATORY BUOYS EXCLUDING THE SEALITE B1452 BUOY Sealite 30% discount from list pricing	5,000.0000	\$	1.0000
3	FLOAT COLLAR CANS 30% discount from list pricing.	5,000.0000	\$	1.0000
4	GREEN CHANNEL MARKERS	5,000.0000	\$	1.0000

9-12-19

 BUYER

 MATERIEL ADMINISTRATOR

STATE OF NEBRASKA CONTRACT AWARD

State Purchasing Bureau
1526 K Street, Suite 130
Lincoln, Nebraska 68508

Telephone: (402) 471-6500
Fax: (402) 471-2089

PAGE 2 of 2		ORDER DATE 09/11/19	
BUSINESS UNIT 33130171		BUYER CHRISTIE KELLY (AS)	
VENDOR NUMBER: 2359922			

CONTRACT NUMBER
14845 OC

Line	Description	Estimated Quantity	Unit of Measure	Unit Price
	30% discount from list pricing			
5	RED CHANNEL MARKERS	5,000.0000	\$	1.0000
	30% discount from list pricing			
6	HARDWARE INCLUDES CABLE CHAIN AND FASTERS	5,000.0000	\$	1.0000
	30% discount from list pricing			
7	RESTORATION MATERIALS	5,000.0000	\$	1.0000
	30% discount from list pricing			

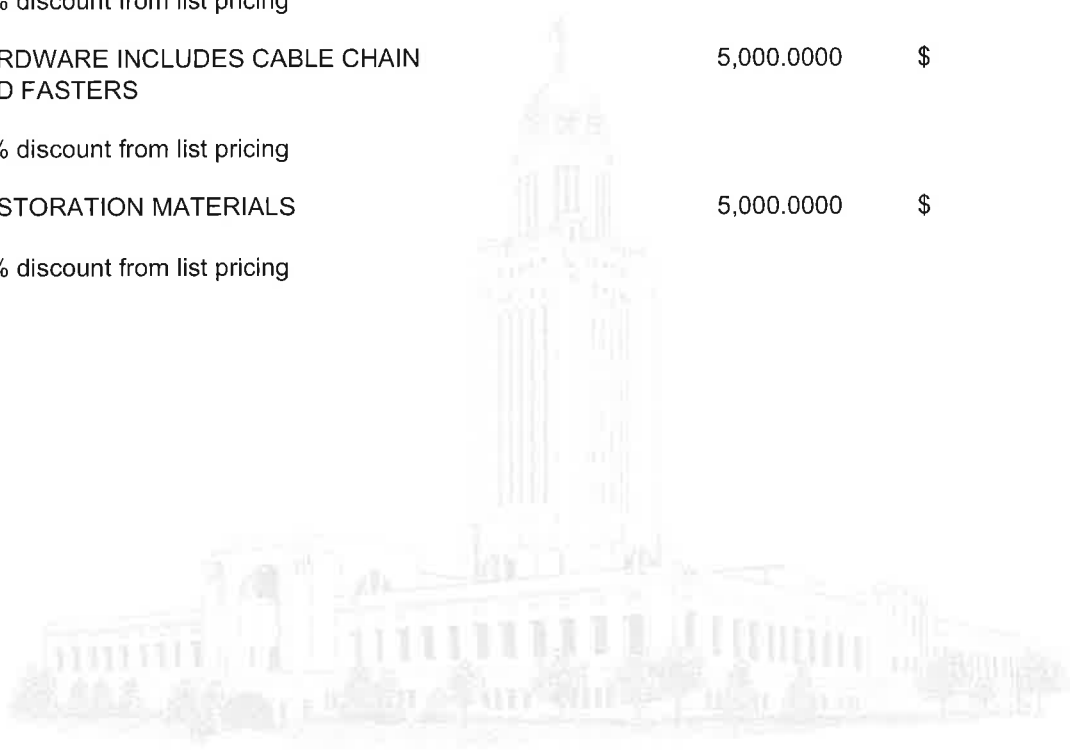

CK by M
BUYER INITIALS

STATE OF NEBRASKA CONTRACT AMENDMENT

State Purchasing Bureau
1526 K Street, Suite 130
Lincoln, Nebraska 68508

Telephone: (402) 471-6500
Fax: (402) 471-2089

CONTRACT NUMBER
14845 OC

PAGE 1 of 2	ORDER DATE 07/10/19
BUSINESS UNIT 33130171	BUYER CHRISTIE KELLY (AS)
VENDOR NUMBER: 2359922	
VENDOR ADDRESS: SEALITE USA LLC 61 BUSINESS PARK DR TILTON NH 03276-5821	

THE CONTRACT PERIOD IS:

SEPTEMBER 27, 2018 THROUGH SEPTEMBER 26, 2019

THIS CONTRACT HAS BEEN AMENDED PER THE FOLLOWING INFORMATION:

NO ACTION ON THE PART OF THE CONTRACTOR NEEDS TO BE TAKEN AT THIS TIME. ORDERS FOR THE MATERIALS AND/OR SERVICES WILL BE MADE AS NEEDED BY THE VARIOUS AGENCIES OF THE STATE.

THIS CONTRACT IS NOT AN EXCLUSIVE CONTRACT TO FURNISH THE MATERIALS AND/OR SERVICES SHOWN BELOW, AND DOES NOT PRECLUDE THE PURCHASE OF SIMILAR MATERIALS AND/OR SERVICES FROM OTHER SOURCES.

THE STATE RESERVES THE RIGHT TO EXTEND THE PERIOD OF THIS CONTRACT BEYOND THE TERMINATION DATE WHEN MUTUALLY AGREEABLE TO THE CONTRACTOR AND THE STATE OF NEBRASKA.

Original/Bid Document 5628 OF

Contract to supply and deliver CAN BUOYS to the State of Nebraska as per the attached specifications for the contract period September 27, 2018 through September 26, 2019. The contract may be renewed for three (3) additional one (1) year periods when mutually agreeable to the vendor and the State of Nebraska.

Vendor Contact: Joseph Richter, Business Development Manager USA
Phone: 603-737-1321
Fax: 603-737-1320
E-Mail: j.richter@sealite.com

This is the first renewal of the contract as amended. (vc 09/25/18)

Amendment One as attached. (7/10/19 sc)

Line	Description	Estimated Quantity	Unit of Measure	Unit Price
1	CAN BUOY 12X51 Make: Sealite Model: B1452	200.0000	EA	214.0000
2	REGULATORY BUOYS EXCLUDING THE SEALITE B1452 BUOY Sealite 30% discount from list pricing	5,000.0000	\$	1.0000
3	FLOAT COLLAR CANS 30% discount from list pricing.	5,000.0000	\$	1.0000

Christie Kelly 7/10/19
BUYER
[Signature] 7/12/19
MATERIEL ADMINISTRATOR

STATE OF NEBRASKA CONTRACT AMENDMENT

State Purchasing Bureau
 1526 K Street, Suite 130
 Lincoln, Nebraska 68508

Telephone: (402) 471-6500
 Fax: (402) 471-2089

CONTRACT NUMBER
14845 OC

PAGE 2 of 2	ORDER DATE 07/10/19
BUSINESS UNIT 33130171	BUYER CHRISTIE KELLY (AS)
VENDOR NUMBER: 2359922	

Line	Description	Estimated Quantity	Unit of Measure	Unit Price
4	GREEN CHANNEL MARKERS 30% discount from list pricing	5,000.0000	\$	1.0000
5	RED CHANNEL MARKERS 30% discount from list pricing	5,000.0000	\$	1.0000
6	HARDWARE INCLUDES CABLE CHAIN AND FASTERS 30% discount from list pricing	5,000.0000	\$	1.0000
7	RESTORATION MATERIALS 30% discount from list pricing	5,000.0000	\$	1.0000

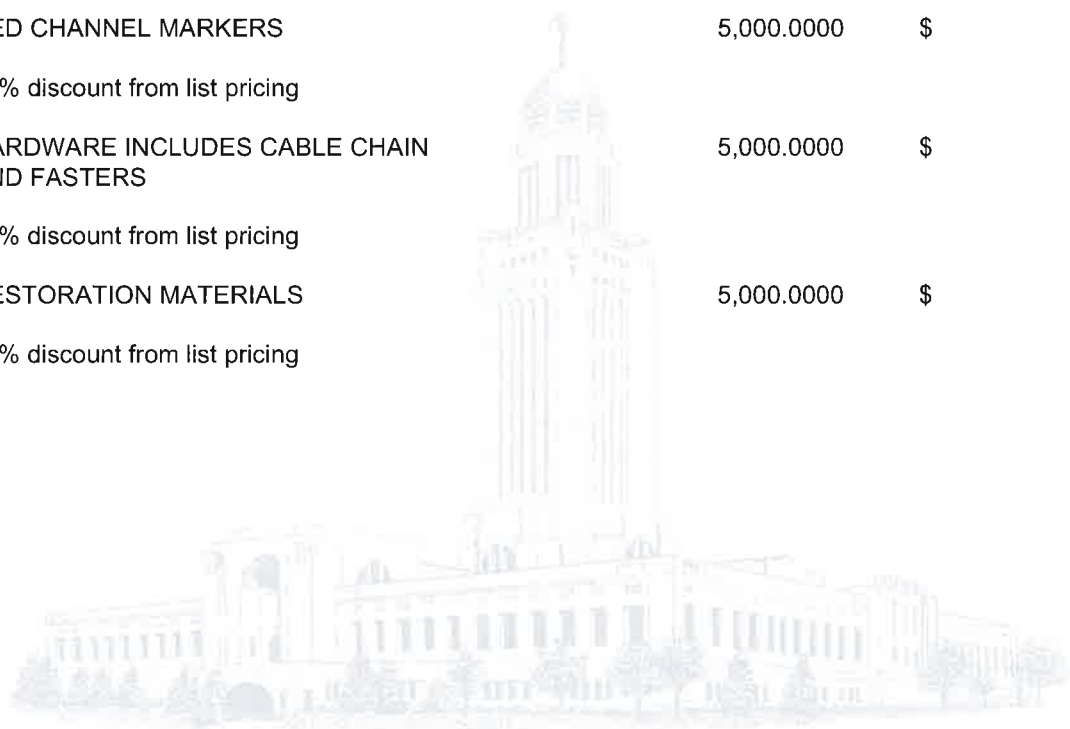

ck
 BUYER INITIALS

AMENDMENT ONE
Contract 14845 OC
Can Buoys for the State of Nebraska
Between
The State of Nebraska and Sealite USA LLC

This Amendment (the "Amendment") is made by the State of Nebraska and Sealite USA LLC, parties to Contract 14845 OC (the "Contract"), and upon mutual agreement and other valuable consideration, the parties agree to and hereby amend the contract upon Execution by both parties as follows:

1. Vendor contact information is hereby superseded and replaced by:

Vendor Contact: Joseph Richter, Business Development Manager USA
Phone: 603-737-1321
Fax: 603-737-1320
Email: j.richter@sealite.com

This amendment and any attachments hereto will become part of the Contract. Except as set forth in this Amendment, the Contract is unaffected and shall continue in full force and effect in accordance with its terms. If there is conflict between this amendment and the Contract or any earlier amendment, the terms of this amendment will prevail.

IN WITNESS WHEREOF, the parties have executed this Amendment as of the date of execution by both parties below.

State of Nebraska

By: 

Name: Douglas P Carlson

Title: Materiel Division Administrator

Date: 7/12/19

Contractor: Sealite USA LLC

By: 

Name: Joseph F Richter III

Title: Business Development Manager USA

Date: July 2, 2019

STATE OF NEBRASKA CONTRACT AWARD

State Purchasing Bureau
1526 K Street, Suite 130
Lincoln, Nebraska 68508

Telephone: (402) 471-6500
Fax: (402) 471-2089

CONTRACT NUMBER
14845 OC

PAGE 1 of 2	ORDER DATE 09/25/18
BUSINESS UNIT 33130171	BUYER JULIE SCHILTZ (AS)
VENDOR NUMBER: 2359922	
VENDOR ADDRESS: SEALITE USA LLC 61 BUSINESS PARK DR TILTON NH 03276-5821	

AN AWARD HAS BEEN MADE TO THE CONTRACTOR NAMED ABOVE FOR THE FURNISHING OF MATERIALS AND/OR SERVICES AS LISTED BELOW FOR THE PERIOD:

SEPTEMBER 27, 2018 THROUGH SEPTEMBER 26, 2019

NO ACTION ON THE PART OF THE CONTRACTOR NEEDS TO BE TAKEN AT THIS TIME. ORDERS FOR THE MATERIALS AND/OR SERVICES WILL BE MADE AS NEEDED BY THE VARIOUS AGENCIES OF THE STATE.

THIS CONTRACT IS NOT AN EXCLUSIVE CONTRACT TO FURNISH THE MATERIALS AND/OR SERVICES SHOWN BELOW, AND DOES NOT PRECLUDE THE PURCHASE OF SIMILAR MATERIALS AND/OR SERVICES FROM OTHER SOURCES.

THE STATE RESERVES THE RIGHT TO EXTEND THE PERIOD OF THIS CONTRACT BEYOND THE TERMINATION DATE WHEN MUTUALLY AGREEABLE TO THE CONTRACTOR AND THE STATE OF NEBRASKA.

Original/Bid Document 5628 OF

Contract to supply and deliver CAN BUOYS to the State of Nebraska as per the attached specifications for the contract period September 27, 2018 through September 26, 2019. The contract may be renewed for three (3) additional one (1) year periods when mutually agreeable to the vendor and the State of Nebraska.

Vendor Contact: Lee Walker
Phone: 603-737-1321
Fax: 603-737-1320
E-Mail: l.walker@sealite.com

This is the first renewal of the contract as amended. (vc 09/25/18)

Line	Description	Estimated Quantity	Unit of Measure	Unit Price
1	CAN BUOY 12X51 Make: Sealite Model: B1452	200.0000	EA	214.0000
2	REGULATORY BUOYS EXCLUDING THE SEALITE B1452 BUOY Sealite 30% discount from list pricing	5,000.0000	\$	1.0000
3	FLOAT COLLAR CANS 30% discount from list pricing.	5,000.0000	\$	1.0000
4	GREEN CHANNEL MARKERS	5,000.0000	\$	1.0000

9.26.18
r

9.25.18
BUYER
MATERIEL ADMINISTRATOR
9/26/18

STATE OF NEBRASKA CONTRACT AWARD

State Purchasing Bureau
1526 K Street, Suite 130
Lincoln, Nebraska 68508

Telephone: (402) 471-6500
Fax: (402) 471-2089

CONTRACT NUMBER
14845 OC

PAGE 2 of 2	ORDER DATE 09/25/18
BUSINESS UNIT 33130171	BUYER JULIE SCHILTZ (AS)
VENDOR NUMBER: 2359922	

Line	Description	Estimated Quantity	Unit of Measure	Unit Price
	30% discount from list pricing			
5	RED CHANNEL MARKERS	5,000.0000	\$	1.0000
	30% discount from list pricing			
6	HARDWARE INCLUDES CABLE CHAIN AND FASTERS	5,000.0000	\$	1.0000
	30% discount from list pricing			
7	RESTORATION MATERIALS	5,000.0000	\$	1.0000
	30% discount from list pricing			

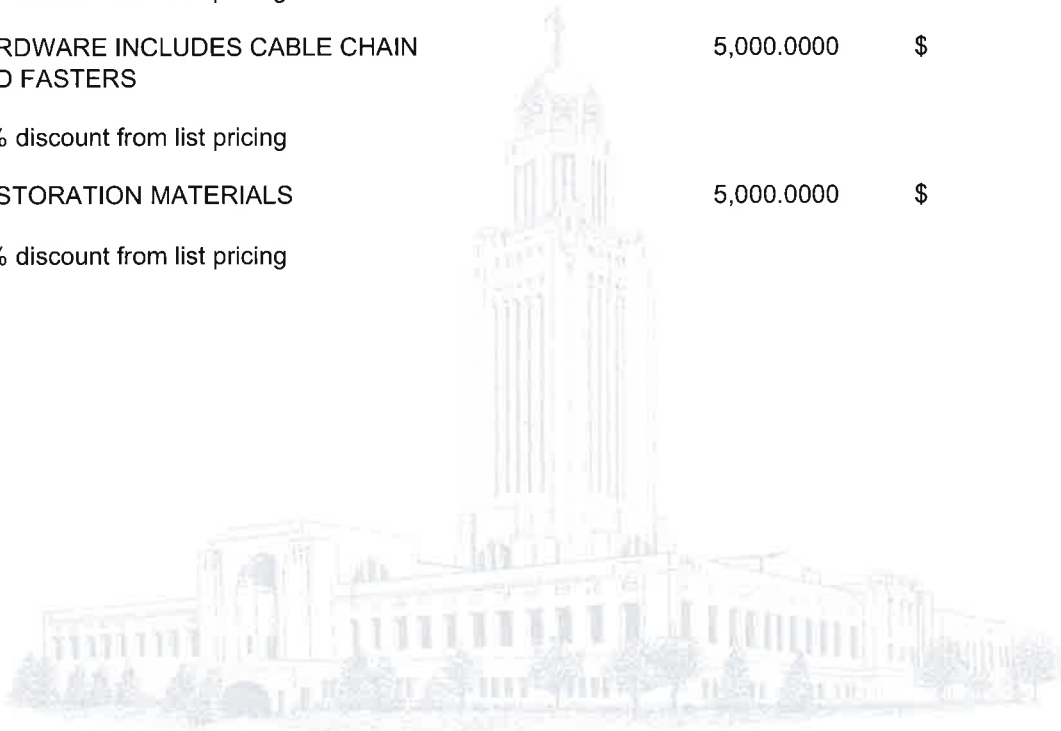

JB
BUYER INITIALS

NEBRASKA

Good Life. Great Service.

DEPT. OF ADMINISTRATIVE SERVICES

CONTRACT RENEWAL

September 17, 2018

Mr. Richter
Sealite USA LLC
61 Business Park Dr.
Tilton, NH 03276-5821

RE: Contract Number 14845 OC, Can Buoys

Dear Mr. Richter:

The above named contract for providing Can Buoys to the State of Nebraska, Game and Parks expires September 26, 2018.

It carries a provision for renewal when mutually agreeable to the Vendor and the State of Nebraska. The State of Nebraska wishes to renew this contract for an additional one (1) year period, i.e. September 27, 2018 through September 26, 2019.

If this is agreeable with Sealite USA LLC., please sign and return as soon as possible, keeping one (1) copy for your files.

If no response is received within thirty (30) calendar days, the State of Nebraska will assume that Sealite USA LLC., does not intend to renew contract number 14845 OC and thus may begin the formal solicitation process to obtain Can Buoys.

Sincerely,

Julie Schiltz, Buyer
State Purchasing Bureau

DATE: 9/17/18

Sealite USA LLC., is agreeable to the renewal of 14845 OC for Can Buoys September 27, 2018 through September 26, 2019.

SIGNATURE: 

TITLE: Inside Sales

DATE: 09/25/2018

***** This agreement is contingent upon a mutually agreed price increase *****

Department of Administrative Services | MATERIEL DIVISION

1526 K Street, Ste. 130
Lincoln, Nebraska 68508

OFFICE 402-471-6500
FAX 402-471-2089

das.nebraska.org

STATE OF NEBRASKA CONTRACT AWARD

State Purchasing Bureau
1526 K Street, Suite 130
Lincoln, Nebraska 68508

Telephone: (402) 471-6500
Fax: (402) 471-2089

CONTRACT NUMBER
14845 OC

PAGE 1 of 2	ORDER DATE 09/25/17
BUSINESS UNIT 33130171	BUYER VACANT (AS)
VENDOR NUMBER: 2359922	
VENDOR ADDRESS: SEALITE USA LLC 61 BUSINESS PARK DR TILTON NH 03276-5821	

AN AWARD HAS BEEN MADE TO THE CONTRACTOR NAMED ABOVE FOR THE FURNISHING OF MATERIALS AND/OR SERVICES AS LISTED BELOW FOR THE PERIOD:

SEPTEMBER 27, 2017 THROUGH SEPTEMBER 26, 2018

NO ACTION ON THE PART OF THE CONTRACTOR NEEDS TO BE TAKEN AT THIS TIME. ORDERS FOR THE MATERIALS AND/OR SERVICES WILL BE MADE AS NEEDED BY THE VARIOUS AGENCIES OF THE STATE.

THIS CONTRACT IS NOT AN EXCLUSIVE CONTRACT TO FURNISH THE MATERIALS AND/OR SERVICES SHOWN BELOW, AND DOES NOT PRECLUDE THE PURCHASE OF SIMILAR MATERIALS AND/OR SERVICES FROM OTHER SOURCES.

THE STATE RESERVES THE RIGHT TO EXTEND THE PERIOD OF THIS CONTRACT BEYOND THE TERMINATION DATE WHEN MUTUALLY AGREEABLE TO THE CONTRACTOR AND THE STATE OF NEBRASKA.

Original/Bid Document 5628 OF

Contract to supply and deliver CAN BUOYS to the State of Nebraska as per the attached specifications for the contract period September 27, 2017 through September 26, 2018. The contract may be renewed for four (4) additional one (1) year periods when mutually agreeable to the vendor and the State of Nebraska.

Vendor Contact: Lee Walker
Phone: 603-737-1321
Fax: 603-737-1320
E-Mail: l.walker@sealite.com

(vc 09/20/17)

Line	Description	Estimated Quantity	Unit of Measure	Unit Price
1	CAN BUOY 12X51 Make: Sealite Model: B1452	200.0000	EA	214.0000
2	REGULATORY BUOYS EXCLUDING THE SEALITE B1452 BUOY Sealite 30% discount from list pricing	5,000.0000	\$	1.0000
3	FLOAT COLLAR CANS 30% discount from list pricing.	5,000.0000	\$	1.0000
4	GREEN CHANNEL MARKERS	5,000.0000	\$	1.0000

9/26/17
pk
Lynn G. Bott 9/26/2017
BUYER
Dorothy Wilken
MATERIEL ADMINISTRATOR

STATE OF NEBRASKA CONTRACT AWARD

State Purchasing Bureau
1526 K Street, Suite 130
Lincoln, Nebraska 68508

Telephone: (402) 471-6500
Fax: (402) 471-2089

CONTRACT NUMBER
14845 OC

PAGE 2 of 2		ORDER DATE 09/25/17	
BUSINESS UNIT 33130171		BUYER VACANT (AS)	
VENDOR NUMBER: 2359922			

Line	Description	Estimated Quantity	Unit of Measure	Unit Price
	30% discount from list pricing			
5	RED CHANNEL MARKERS	5,000.0000	\$	1.0000
	30% discount from list pricing			
6	HARDWARE (INCLUDES CABLE CHAIN AND FASTERS)	5,000.0000	\$	1.0000
	30% discount from list pricing			
7	RESTORATION MATERIALS	5,000.0000	\$	1.0000
	30% discount from list pricing			

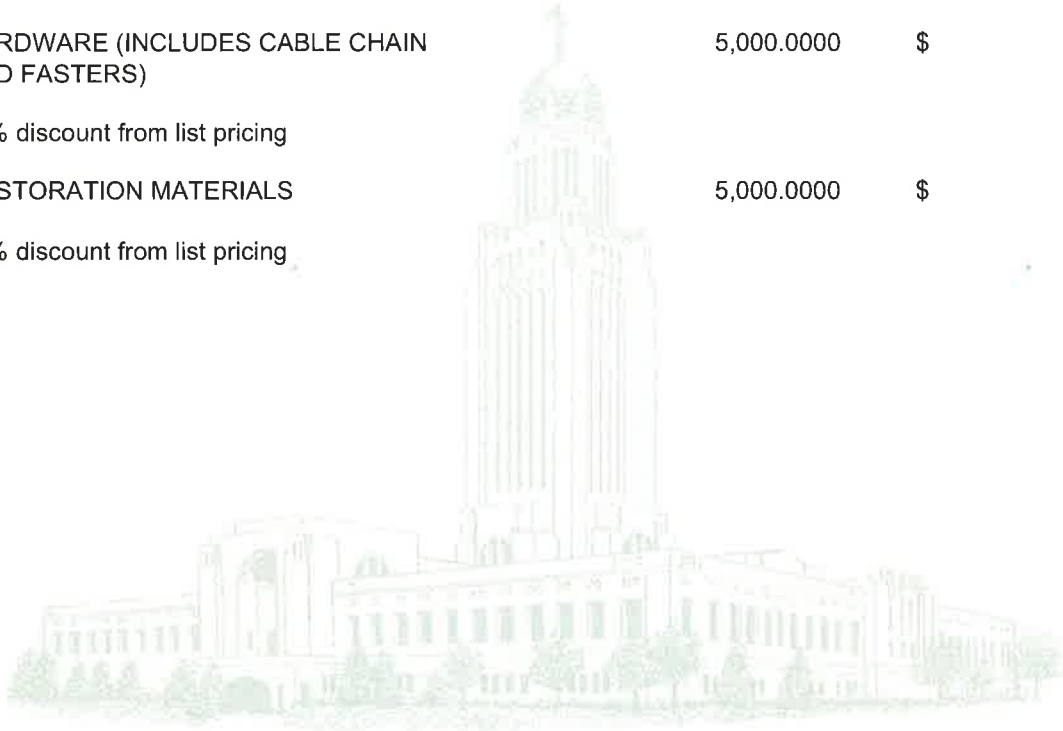

RAB

BUYER INITIALS

STATE OF NEBRASKA SOL # 5628 OF		9/22/2017 hbc	
SEALITE USA LLC PRICING FOR LINES 2-8			
LINE #	PART No	RETAIL PRICE USD	30% DISCOUNTED PRICE
2	SL-B576-RB	\$ 113.00	\$ 79.10
2	SL-B980-RB	\$ 315.00	\$ 220.50
2	SL-B1060-RB	\$ 201.00	\$ 140.70
2	SL-B700-RB	\$ 388.00	\$ 271.60
2	SL-B1428E-RB	\$ 475.00	\$ 332.50
			\$ -
3	SL-B700-CAN	\$ 376.00	\$ 263.20
3	SL-B1428-SW-RB-W	\$ 379.00	\$ 265.30
			\$ -
4	SL-B576-G	\$ 98.00	\$ 68.60
4	SL-B980-G	\$ 255.00	\$ 178.50
4	SL-B1060-G	\$ 175.00	\$ 122.50
			\$ -
5	SL-B576-R	\$ 98.00	\$ 68.60
5	SL-B980-R	\$ 255.00	\$ 178.50
5	SL-B1060-R	\$ 175.00	\$ 122.50
			\$ -
6	M-CH-5/8G galvanized chain 5/8"/ft	\$ 10.00	\$ 7.00
6	M-SW-5/8G galvanized swivel 5/8"	\$ 18.00	\$ 12.60
6	M-SH-5/8G galvanized shackle	\$ 8.00	\$ 5.60
6	M-CA-1/4G galvanized cable/ft	\$ 0.45	\$ 0.32
6	M-SW-3/8G galvanized swivel 3/8"	\$ 6.00	\$ 4.20
6	M-SH-3/8G galvanized shackle	\$ 3.00	\$ 2.10
6	M-CL-1/4G galvanized cable clamp	\$ 1.00	\$ 0.70
6	M-TH-1/4G galvanized cable thimble	\$ 0.41	\$ 0.29
7	SL-B576-GRKIT	\$ 19.00	\$ 13.30
7	SL-B980-GRKIT	\$ 27.00	\$ 18.90
7	SL-B1060-RB-GRKIT	\$ 27.00	\$ 18.90
7	SL-B700-RB-GRKIT	\$ 31.00	\$ 21.70
8	SL-15, 1-2NM SOLAR LANTERN	\$ 201.00	\$ 140.70
8	SL-60, 2-3NM SOLARLANTERN	\$ 397.00	\$ 277.90
8	SL-70, 2-3NM SOLARLANTERN	\$ 435.00	\$ 304.50
8	SL-75, 3-5NM SOLAR LANTERN	\$ 568.00	\$ 397.60
			\$ -
8	M-MW-75, 75 lb mooring wt, SS eye	\$ 70.00	\$ 49.00
8	M-MW-150, 150 lb mooring wt, SS eye	\$ 118.00	\$ 82.60
8	M-MW-250, 250 lb mooring wt, SS eye	\$ 194.00	\$ 135.80



Buoys and Moorings



Inland Waterway and Shallow Harbor Solutions

Introduction

Thank you for considering Sealite for your marine marking needs. Sealite is a major supplier to federal, state and local marine authorities including the U.S. Coast Guard and the U.S. Navy. Sealite's buoy and float products are rotationally molded in our New Hampshire factory to the same exacting standards as our offshore and coastal buoy products. The products utilize the same premium quality polyethylene and closed cell foam materials for optimal performance. Our sole focus is improving the safety of mariners by developing state of the art aids to navigation; we don't make pool products or medical supplies like some other companies. Call us for custom solutions to your marking challenges. We look forward to working with you.



Sealite is one of the only full-line navigation aid producers to manufacture marine buoys on-site with state of the art rotational molding equipment; in-house manufacturing allows us to ensure marine buoys are robust and able to withstand the most severe weather conditions.

Table of Contents

	Page #
Introduction	2
Buoy Terminology	3
The Sealite Advantage	4
Mooring/Installation Examples	5
Regulatory Spar Buoys	6
Regulatory Float Collar Buoys	8
Regulatory Signage	10
Special Marking Options	10
Regulatory Wraps	11
Restoration Kits	11
Channel Marker Spar Buoys	12
Channel Marker Float Collar Buoys	14
Solar Marine Lanterns	16
Barrier Floats	18
Buoy and Barrier Float Examples	20
Daymarks & Signage	21
Mooring Buoys	22
Winter Mooring Sticks	23
Elastic Conservation Mooring System	24
Mooring Hardware	26
Mooring Weights	27

Note: Content is implied for general information only. Sealite assumes no responsibility for installations based on examples shown.

Buying a Buoy: Important Terminology

When choosing a Sealite buoy, it is important to understand exactly what size and type will suit your particular application. Sealite strives to provide straightforward terminology to assist you in your selection. Here's what you need to know, and why it's important.

Term	Explanation
Overall Height	Total buoy height, including any external counterweight.
Nominal Freeboard	Height of the buoy above the water line in a typical installation. Freeboard may vary slightly due to differences in water density, mooring load, and current speed.
Nominal Draft	Length of the buoy that is under water. Like Freeboard, draft can vary due to particular installations.
Visual Area (or Exposure)	Visible area of a buoy, calculated from freeboard and the diameter of the buoy. Visual Area is a key measure of the visibility of a Navigation Aid to mariners.
Submergence	Amount of weight necessary to sink a buoy one inch (or centimeter).
Maximum Mooring Load	Maximum weight of the mooring load for a buoy to still achieve Nominal Freeboard.
Wall Thickness	Thickness of the rotationally molded plastic wall.
Diameter	Overall width of the buoy. May be more than one [diameter] if float collar type of buoy.
Reserve Buoyancy	Amount of product weight and the required buoyancy required to keep it afloat.

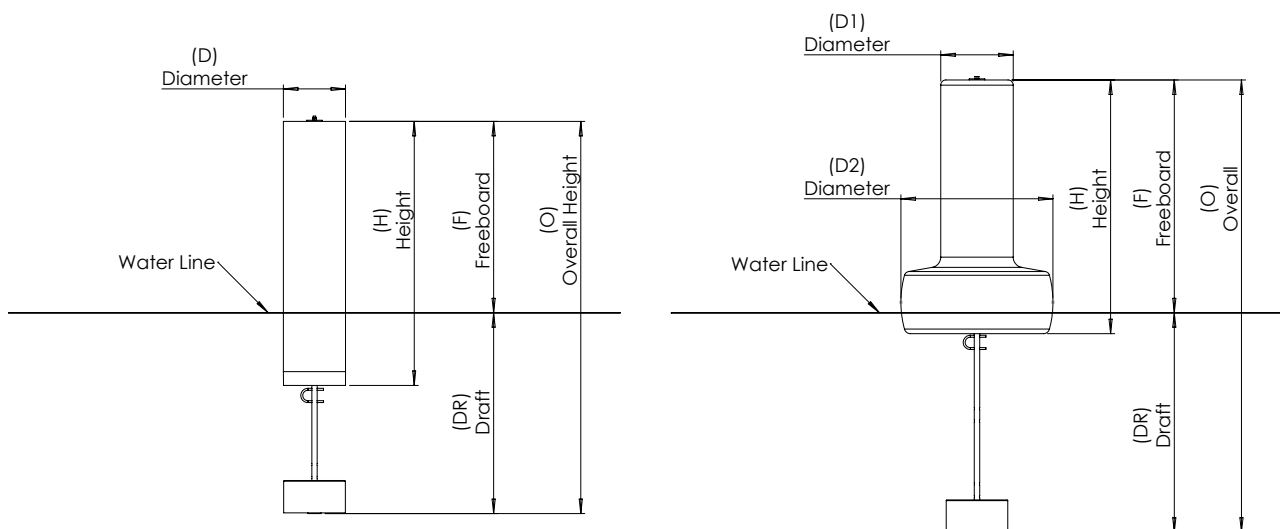



Advantages of Sealite vs. Competitor

	Sealite	Competitor
Process	Rotationally molded polyethylene is poured into a mold and then spun on a rotational molding machine for uniform thickness.	Sheets of plastic are vacuum formed or heated to form the desired buoy shape.
Construction	Seamless, all Sealite products are molded as single pieces for uniform strength.	Seams are evident where the sheets of plastic are joined together, creating potential weak spots.
Materials	No toxic chemicals or heavy metals are ever used in the manufacture of any Sealite buoy products.	ABS may require the use of toxic materials to increase impact strength and to maintain the ability to form into shape.
Chemical Resistance	Polyethylene has exceptionally high resistance to fuels, oils, and other human by-products that reside in the maritime environment.	ABS requires the addition of Butadiene to be chemical resistant. Butadiene is extremely toxic and harmful to humans and animals.
Moisture Resistance	Polyethylene is classed as polyolefin material which exhibits an extremely high level of moisture resistance.	ABS is moisture resistant...when toxic ingredients are added. As a hygroscopic material, moisture and water particles will absorb into it.
Non-Marine Uses	Surgical implants and surgical tubing, etc.	Automotive trim, (small) appliances like toaster-ovens and coffee makers, and other applications and products that require heat resistance and flame retardancy.
UV-Stabilization & Color Stability	Only Sealite adds a UV stabilizing compound to both the polyethylene and coloring agents, providing additional protection from the degrading effects of UV exposure.	UV stabilizer added (oftentimes upon request only) to ABS. ABS materials with high levels of toxic Butadiene can be difficult to compound colors into.
Filling	Closed cell polyurethane foam means any potential water ingress will not permeate the foams' closed cells, allowing for a more buoyant product should the buoy sustain damage.	Regular, open cell foam filling can become saturated if a buoy is punctured, allowing water to penetrate and saturate each cell, adding weight and adding to the risk of submergence.

It's easy to tell when the buoy you're passing is NOT from Sealite!

Buoy from "other" manufacturer



Sealite's Rotationally Molded Polyethylene Buoy



Mooring/Installation Examples

Chain mooring on spar buoy

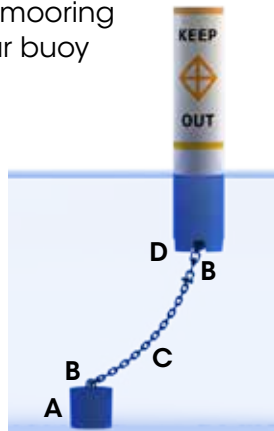

Cable mooring on spar buoy

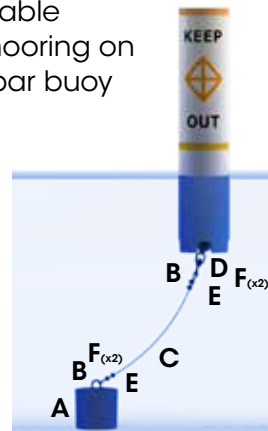

Fast water side mooring for float collar buoys



Chain mooring on float collar buoy with external counterweight (standard installations)

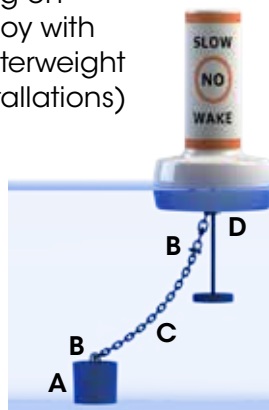

Shallow water chain mooring for float collar buoy

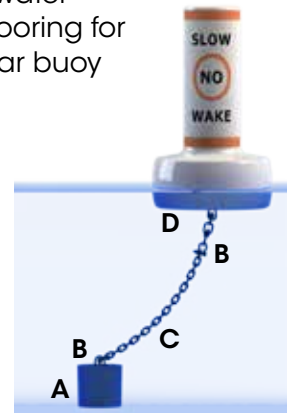

Spar buoy with barrier floats (Dam, Swim Area Marking) using chain

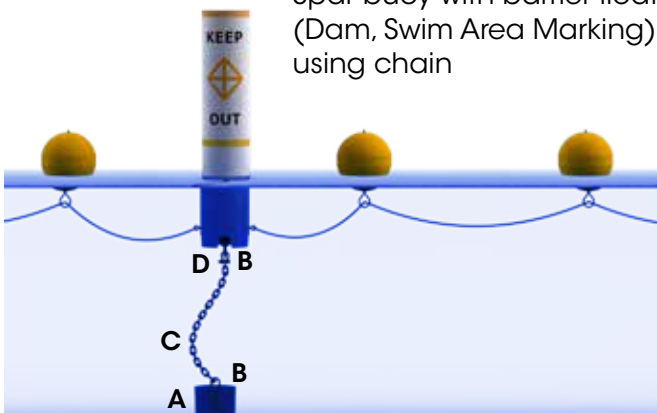

Mooring System Key

A	Mooring Weight
B	Shackle
C	Chain or cable
D	Swivel at buoy/chain connection point
E	Thimbles
F	Cable Clamps

See pages 24-27 for Sealite's mooring accessories

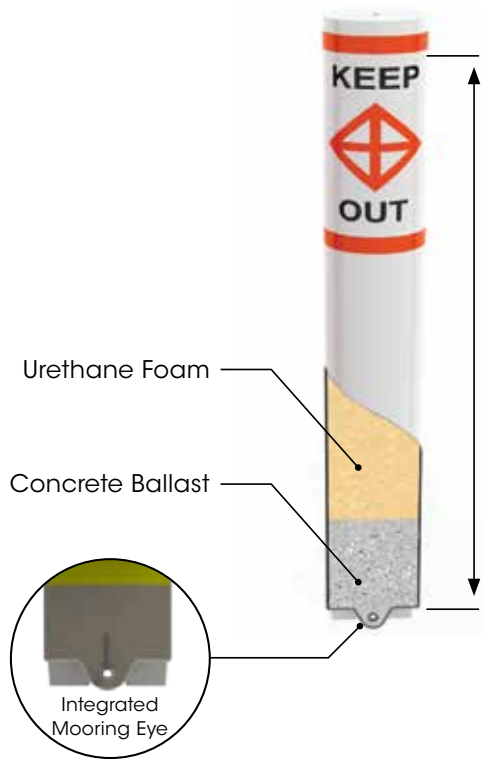

Features

- Integrated stainless steel mooring eye (SL-B576, SL-B980, SL-B1060, SL-B1362) during molding process results in completely sealed, virtually unsinkable, watertight buoy
- Recessed mooring eye allows buoy to be stored upright with hardware attached for ease of deployment and storage
- 3-inch wide band of USCG approved retroreflective tape
- Self righting without tackle
- Standard messages (see pg. 10) included as standard
- UV inhibited polyethylene for extreme durability in harsh sunlight

Options

- 3-inch wide silver top reflective tape for added visibility
- Solar lantern (see table below)
- Custom signage
- Mold in graphics
- Alternative colors available (yellow or orange)

SL-B576, 980, 1060, 1362 feature an integrated mooring eye and internal concrete ballast

Mooring Suggestions on page 5



Specifications	SL-B576-RB	SL-B980-RB	SL-B1060-RB	SL-B1362-RB	SL-B1251E-RB
Diameter (in/mm) - D	5 (127)	9 (229)	9 (229)	13 (330)	12 (305)
Buoy Height (in/mm) - H	76 (1930)	80 (2032)	61 (1549)	62 (1575)	51 (1295)
Overall Height (in/mm) - O	76 (1930)	80 (2032)	61 (1549)	62 (1575)	75 (1905)
Nominal Freeboard (in/mm) - F	36 (914)	42 (1067)	36 (914)	40 (1016)	38 (965)
Visual Area (ft ² /m ²)	1.25 (0.12)	2.5 (0.24)	2.25 (0.2)	3.6 (0.33)	3 (0.27)
Submergence (lb/in; kg/cm)	0.75 (0.13)	3 (0.5)	3 (0.5)	4.8 (0.9)	4 (0.7)
Nominal Draught (in/mm) - DR	40 (1016)	38 (965)	25 (635)	22 (559)	37 (940)
Net weight (lb/kg)	23 (10)	78 (35)	63 (29)	102 (46)	80 (36)
Max Mooring Load (lb/kg)	5 (2)	25 (11)	12 (5)	21 (9.5)	8 (3.6)
Wall Thickness (in/mm)	0.2 (5)	0.2 (5)	0.2 (5)	0.2 (5)	0.2 (5)
Optional Solar Lantern (pgs. 16-17)	N/A	SL-15, SL-60	SL-15, SL-60	SL-15, SL-60, SL-70	SL-15*, SL-60*

* Requires external lantern plate

Regulatory Spar Buoys

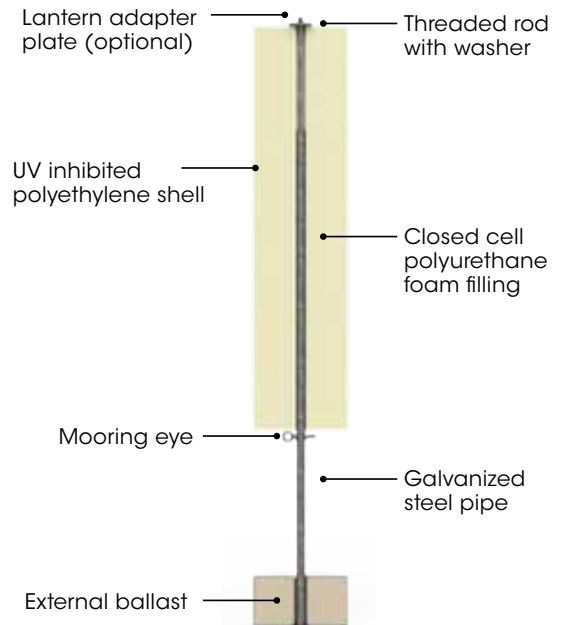

Mooring Suggestions
on page 5

Specifications	SL-B1 352E-RB	SL-B1 362E-RB	SL-B1 452E-RB	SL-B2445E-RB	SL-B2460E-RB
Diameter (in/mm) - D	13 (330)	13 (330)	14 (356)	24 (609)	24 (609)
Buoy Height (in/mm) - H	52 (1321)	62 (1575)	52 (1321)	45 (1143)	60 (1524)
Overall Height (in/mm) - O	76 (1930)	86 (2184)	76 (1930)	90 (2286)	105 (2667)
Nominal Freeboard (in/mm) - F	40 (1016)	40 (1016)	40 (1016)	39 (990)	51 (1295)
Visual Area (ft ² /m ²)	3.6 (0.33)	3.6 (0.33)	3.8 (0.35)	6.5 (0.6)	8.5 (0.79)
Submergence (lb/in; kg/cm)	4.8 (0.9)	4.8 (0.9)	5.5 (0.98)	16 (2.9)	16 (2.9)
Nominal Draft (in/mm) - DR	36 (914)	46 (1168)	36 (914)	51 (1295)	54 (1372)
Net weight (lb/kg)	83 (38)	113 (51)	86 (39)	145 (66)	240 (109)
Max Mooring Load (lb/kg)	17.25 (7.8)	17.25 (7.8)	21 (9.5)	52 (23)	243 (110)
Wall Thickness (in/mm)	0.2 (5)	0.2 (5)	0.2 (5)	0.2 (5)	0.2 (5)
Optional Solar Lantern (pgs. 16-17)	SL-15*, SL-60*, SL-70*	SL-15*, SL-60*, SL-70*	SL-15*, SL-60*, SL-70*	SL-15*, SL-60*, SL-70*, SL-75*	SL-15*, SL-60*, SL-70*, SL-75*

Regulatory Float Collar Buoys



Made in USA



Features

- Excellent stability for rough, choppy conditions
- Large buoy base for increased reserved buoyancy
- Standard messages (see page 10) included as standard
- UV inhibited polyethylene for extreme durability in harsh sunlight
- Superior durability and strength

Options

- Solar lantern (see table below)
- Mold in graphics
- Alternative colors available (yellow or orange)



SL-B600-RB



SL-B700-RB



SL-B1428SW-RB



SL-B1428FW-RB



SL-B1428E-RB

Mooring Suggestions
on page 5

* Requires external lantern plate

Specifications	SL-B600-RB	SL-B700-RB	SL-B1428SW-RB	SL-B1428FW-RB	SL-B1428E-RB
Diameter (in/mm) - D	23.5 (600)	Collar: 12(305) Can: 27.5(700)	Collar: 14 (356) Can: 28 (711)	Collar: 14 (356) Can: 28 (711)	Collar: 14 (356) Can: 28 (711)
Buoy Height (in/mm) - H	45.3 (1150)	54 (1372)	49 (1245)	49 (1245)	49 (1245)
Overall Height (in/mm) - O	45.3 (1150)	54 (1372)	52.5 (1334)	49 (1245)	87 (2210)
Nominal Freeboard (in/mm) - F	36 (914)	44 (1118)	44 (1118)	44 (1118)	44 (1118)
Visual Area (ft ² /m ²)	2.0 (0.186)	2.75 (0.255)	4.27 (0.4)	4.27 (0.4)	4.27 (0.4)
Submergence (lb/in; kg/cm)	16 (3)	21.5 (3.8)	22 (4)	22 (4)	22 (4)
Nominal Draft (in/mm) - DR	10 (250)	8.75 (223)	8.5 (216)	5 (127)	43 (1092)
Net weight (lb/kg)	41 (18.5)	94 (43)	108 (49)	108 (49)	125 (57)
Max Mooring Load (lb/kg)	57 (26)	132 (60)	173 (79)	40 (18)	97 (44)
Wall Thickness (in/mm)	0.25 (7)	0.25 (7)	0.2 (5)	0.2 (5)	0.2 (5)
Optional Solar Lantern (pgs. 16-17)	SL-15*, SL-60*, SL-70*	SL-15, SL-60, SL-70*	SL-15, SL-60, SL-70*	SL-15, SL-60, SL-70*	SL-15*, SL-60*, SL-70*

Regulatory Float Collar Buoys

SL-B1200 Fast Water Buoy has a unique hull shaped design which makes it suitable for fast water to 8 knots.



SL-B1200FW-RB

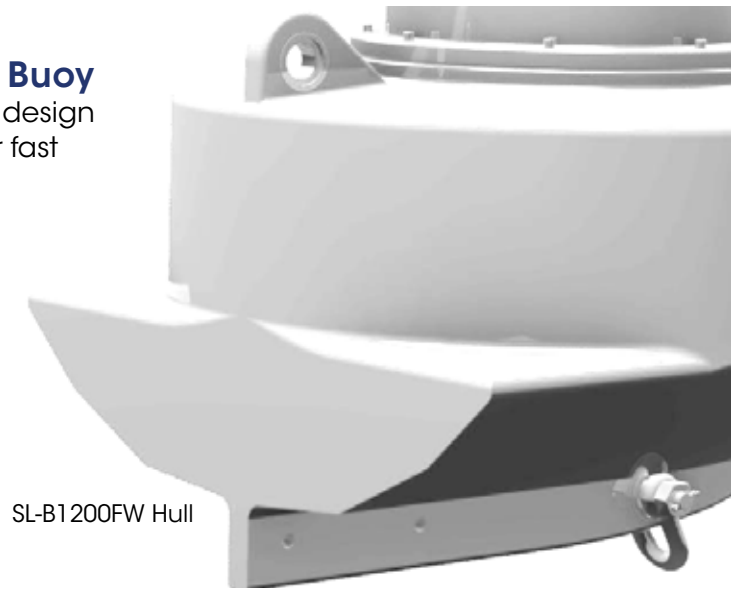

SL-B1200FW Hull



SL-B1250-RB

Contact Sealite customer service for mooring solutions.

Specifications	SL-B1200FW-RB	SL-B1250-RB
Diameter (in/mm) - D	Collar: 21.9 (555) Can: 47.25 (1200)	Collar: 21.9 (555) Can: 49.25 (1250)
Buoy Height (in/mm) - H	68 (1745)	50 (1270)
Overall Height (in/mm) - O	68 (1745)	68 (1727)
Nominal Freeboard (in/mm) - F	49 (1244)	46.5 (1181)
Visual Area (ft ² /m ²)	8.1 (0.75)	8.6 (0.8)
Submergence (lb/in; kg/cm)	70 (12.5)	70 (12.5)
Nominal Draft (in/mm) - DR	15.75 (402)	21.5 (546)
Net weight (lb/kg)	313 (142)	154 (70)
Max Mooring Load (lb/kg)	172 (78)	342 (155)
Wall Thickness (in/mm)	Float collar: .375 (9) Can top: .25 (7)	Float collar: .375 (9) Can top: .25 (7)
Optional Solar Lantern (pgs. 16-17)	SL-15, SL-60, SL-70, SL-75	SL-15, SL-60, SL-70, SL-75

Regulatory Signage & Special Marking Options



Made in USA

A variety of standard signage is available for all of Sealite's Regulatory Buoys. Custom graphics are available upon request.

CONTROLLED AREA	RESTRICTED AREA	HAZARD WARNING	INFORMATION
STANDARD MESSAGES SLOW NO WAKE IDLE SPEED NO WAKE 5MPH NO WAKE 10MPH NO SKI SKI AREA NO RAFTING	STANDARD MESSAGES SWIM AREA KEEP OUT NO BOATS RESTRICTED AREA DANGER KEEP OUT CLOSED AREA	STANDARD MESSAGES DANGER DANGER DAM ROCK SHOAL HAZARD AREA DANGER PIPELINE CONSTRUCTION	STANDARD MESSAGES MARINA ENTRANCE FISH ATTRACTOR

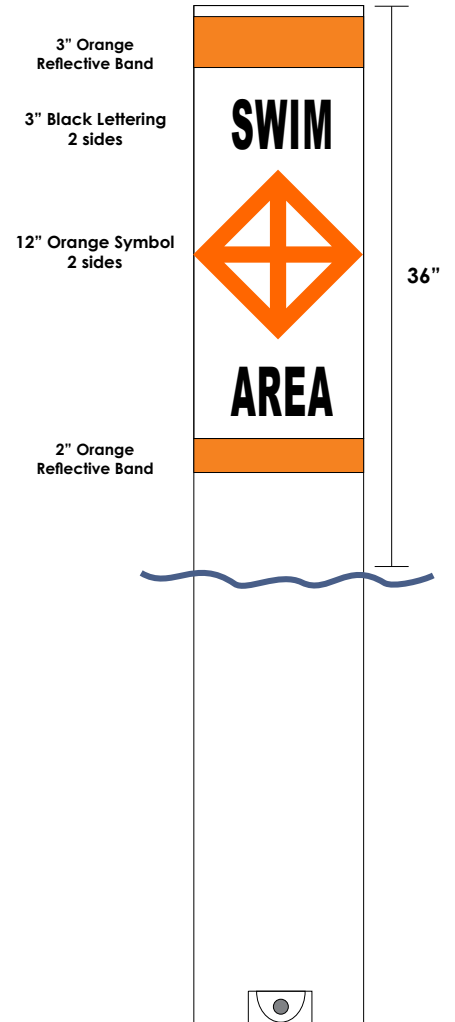

Shoreline Marker

Safe Water

Wreck Marker

Dredge Line Markers

Race Course Marker

Special Marking Options

Any of Sealite's buoys can be ordered in special configurations. Common examples are listed below. Other configurations available upon request.

Regulatory Wraps & Restoration Kits

Regulatory Wraps

Sealite Vinyl Wraps are perfect for restoring or repurposing older buoys. Wraps include:

- Two retroreflective orange bands as standard
- 13oz heavy-duty white vinyl material
- All material for attaching to buoy
- Available for most Sealite Regulatory Buoys

Options

- Custom graphics or logo
- Silver retroreflective band

Vinyl Wrap Kits

Model #	Fits Buoy Model #
SL-BWRAP1060	SL-B1060 Spar
SL-BWRAP700	SL-B700 Float Collar
SL-BWRAP1251	SL-B1251 Spar
SL-BWRAP1352	SL-B1352 Spar
SL-BWRAP1362	SL-B1362 Spar
SL-BWRAP1428	SL-B1428 Float Collar
SL-BWRAP1452	SL-B1452 Spar
SL-BWRAP2445	SL-B2445 Spar
SL-BWRAP2460	SL-B2460 Spar
SL-BWRAP1200	SL-B1200 Float Collar
SL-BWRAP1250	SL-B1250 Float Collar

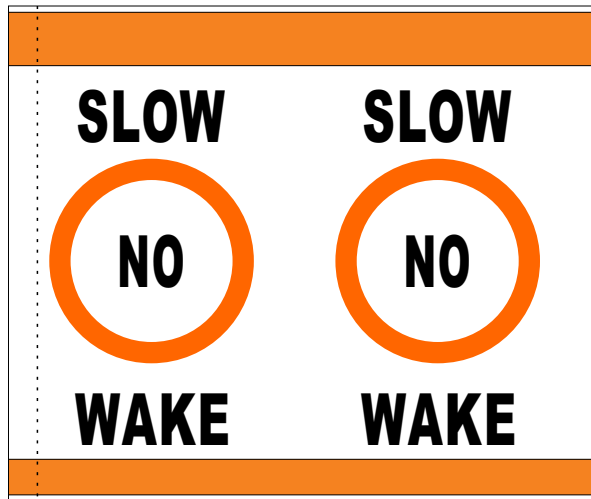

Restoration Kits (right)

Heavy duty vinyl decal kits to refurbish or repurpose older buoys

- Available for all Sealite Regulatory Buoys
- Includes two sets of retroreflective orange bands, black letters, and orange symbols

Options

- Custom graphics or logo

Custom Graphics Always Available!

Conservation groups, private clubs, and yacht clubs love our custom graphics. We can design a wrap to suit your particular marking needs!



Channel Marker Spar Buoys



Made in USA

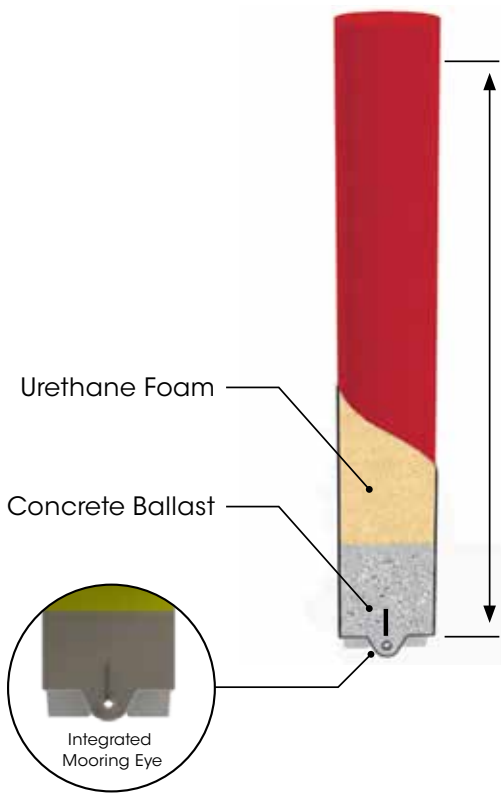

Features

- Integrated stainless steel mooring eye (SL-B576, SL-B980, SL-B1060, SL-B1362) during molding process results in completely sealed, virtually unsinkable, watertight buoy
- Replaceable ballast and galvanized mooring post (external ballast buoys only)
- Self righting without tackle
- UV inhibited polyethylene for extreme durability in harsh sunlight
- Closed cell polyurethane foam filling—virtually unsinkable

Options

- 3-inch wide USCG approved retroreflective tape for added visibility
- Solar lantern (see table below)

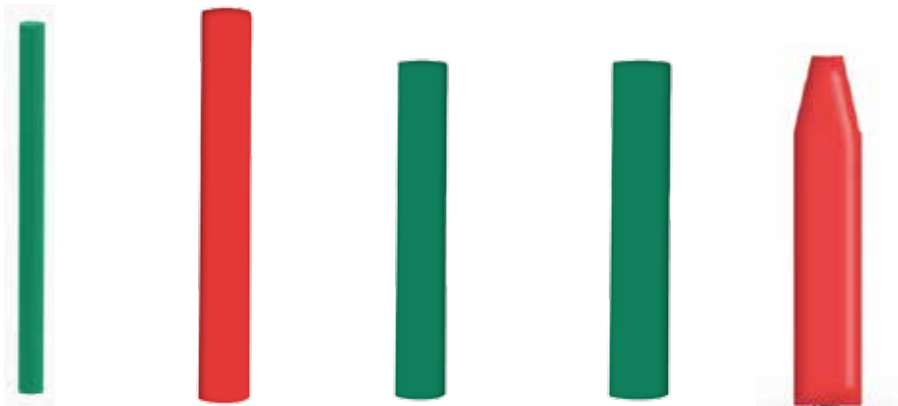

Specifications	SL-B576	SL-B980	SL-B1060	SL-B1362-CAN	SL-1362-NUN
Diameter (in/mm) - D	5 (127)	9 (229)	9 (229)	13 (330)	13 (330)
Buoy Height (in/mm) - H	76 (1930)	80 (2032)	61 (1549)	62 (1575)	62 (1575)
Overall Height (in/mm) - O	76 (1930)	80 (2032)	61 (1549)	62 (1575)	62 (1575)
Nominal Freeboard (in/mm) - F	36 (914)	42 (1067)	36 (914)	40 (1016)	40 (1016)
Visual Area (ft ² /m ²)	1.25 (0.12)	2.5 (0.24)	2.25 (0.2)	3.6 (0.33)	3.6 (0.33)
Submergence (lb/in; kg/cm)	0.75 (0.13)	3 (0.5)	3 (0.5)	4.8 (0.9)	4.8 (0.9)
Nominal Draft (in/mm) - DR	40 (1016)	38 (965)	25 (635)	22 (559)	22 (559)
Net weight (lb/kg)	23 (10)	78 (35)	63 (29)	102 (46)	102 (46)
Max Mooring Load (lb/kg)	5 (2)	25 (11)	12 (5)	21 (9.5)	21 (9.5)
Wall Thickness (in/mm)	0.2 (5)	0.2 (5)	0.2 (5)	0.2 (5)	0.2 (5)
Optional Solar Lantern (pgs. 16-17)	N/A	SL-15, SL-60	SL-15, SL-60	SL-15, SL-60, SL-70	SL-15, SL-60*, SL-70*

* Requires external lantern plate

Channel Marker Spar Buoys

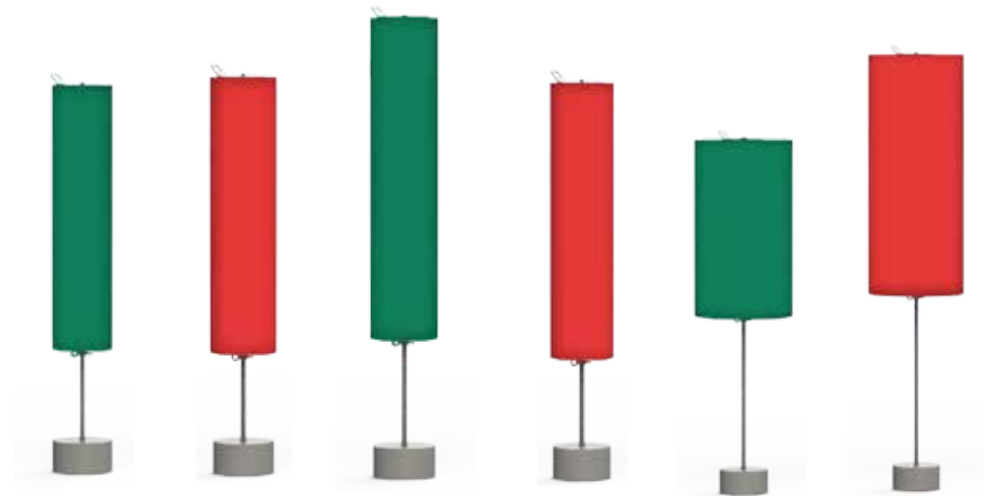
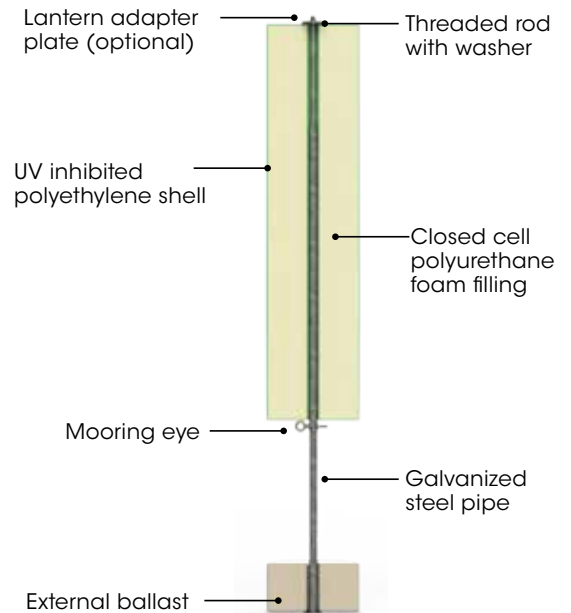

Mooring Suggestions
on page 5

Specifications	SL-1251E	SL-1352E	SL-B1362E	SL-B1452E	SL-B2445E	SL-B2460E
Diameter (in/mm) - D	12 (305)	13 (330)	13 (330)	14 (356)	24 (609)	24 (609)
Buoy Height (in/mm) - H	51 (1295)	52 (1321)	62 (1575)	52 (1321)	45 (1143)	60 (1524)
Overall Height (in/mm) - O	75 (1905)	76 (1930)	86 (2184)	76 (1930)	90 (2286)	105 (2667)
Nominal Freeboard (in/mm) - F	38 (965)	40 (1016)	40 (1016)	40 (1016)	39 (990)	51 (1295)
Visual Area (ft ² /m ²)	3 (0.27)	3.6 (0.33)	3.6 (0.33)	3.8 (0.35)	6.5 (0.6)	8.5 (0.79)
Submergence (lb/in; kg/cm)	4 (0.7)	4.8 (0.9)	4.8 (0.9)	5.5 (0.98)	16 (2.9)	16 (2.9)
Nominal Draft (in/mm) - DR	37 (940)	36 (914)	46 (1168)	36 (914)	51 (1295)	54 (1372)
Net weight (lb/kg)	80 (36)	83 (38)	113 (51)	86 (39)	145 (66)	240 (109)
Max Mooring Load (lb/kg)	8 (3.6)	17.25 (7.8)	17.25 (7.8)	21 (9.5)	52 (23)	243 (110)
Wall Thickness (in/mm)	0.2 (5)	0.2 (5)	0.2 (5)	0.2 (5)	0.2 (5)	0.2 (5)
Optional Solar Lantern (pgs. 16-17)	SL-15*, SL-60*	SL-15*, SL-60*, SL-70*	SL-15*, SL-60*, SL-70*	SL-15*, SL-60*, SL-70*	SL-15*, SL-60*, SL-70*, SL-75*	SL-15*, SL-60*, SL-70*, SL-75*

Channel Marker Float Collar Buoys



Made in USA



Left: SL-B700 Nun
Long lasting color is a hallmark of Sealite's buoys even when installed in tropical waters.

Features

- Excellent stability for rough, choppy conditions
- Large buoy base for increased reserved buoyancy
- UV inhibited polyethylene for extreme durability in harsh sunlight
- Superior durability and strength
- Multiple colors available: red, green, yellow

Options

- Solar lantern (see table below)
- Can or nun tops (SL-B700, 1200, 1250)



Mooring Suggestions on page 5

* Requires external lantern plate

Specifications	SL-B600	SL-B700 -CAN	SL-B700 -NUN	SL-B1428SW	SL-B1428FW	SL-B1428E
Diameter (in/mm) - D	23.5 (600)	27.5 (700)	27.5 (700)	Collar: 14 (356) Can: 28 (711)	Collar: 14 (356) Can: 28 (711)	Collar: 14 (356) Can: 28 (711)
Buoy Height (in/mm) - H	45.3 (1150)	54 (1372)	54 (1372)	49 (1245)	49 (1245)	49 (1245)
Overall Height (in/mm) - O	45.3 (1150)	54 (1372)	54 (1372)	52.5 (1334)	49 (1245)	87 (2210)
Nominal Freeboard (in/mm) - F	36 (914)	44 (1118)	44 (1118)	44 (1118)	44 (1118)	44 (1118)
Visual Area (ft / m)	2.0 (0.186)	2.75 (0.255)	2.75 (0.255)	4.27 (0.4)	4.27 (0.4)	4.27 (0.4)
Submergence (lb/in; kg/cm)	16 (3)	21.5 (3.8)	21.5 (3.8)	22 (4)	22 (4)	22 (4)
Nominal Draft (in/mm) - DR	10 (250)	8.75 (223)	8.75 (223)	8.5 (216)	5 (127)	43 (1092)
Net weight (lb/kg)	41 (18.5)	94 (43)	94 (43)	108 (49)	108 (49)	125 (57)
Max Mooring Load (lb/kg)	57 (26)	132 (60)	132 (60)	173 (79)	40 (18)	97 (44)
Wall Thickness (in/mm)	0.25 (7)	0.25 (7)	0.25 (7)	0.2 (5)	0.2 (5)	0.2 (5)
Optional Solar Lantern (pgs. 16-17)	SL-15*, SL-60*, SL-70*	SL-15, SL-60, SL-70*	SL-15, SL60*, SL-70*	SL-15, SL-60, SL-70*	SL-15, SL-60, SL-70*	SL-15*, SL-60*, SL-70*



Channel Marker Float Collar Buoys



Features

- Excellent stability for heavy duty installations
- Large buoy base for increased reserved buoyancy
- UV inhibited polyethylene for extreme durability in harsh sunlight
- Superior durability and strength
- Multiple colors available: red, green, yellow

Options

- Solar lantern (see table below)
- Can or nun tops

SL-B1200 Fast Water Buoy

has a unique hull shaped design which makes it suitable for fast water to 8 knots.



Contact Sealite customer service for mooring solutions

Specifications	SL-B1200-CAN	SL-B1200-NUN	SL-B1250-CAN	SL-B1250-NUN
Diameter (in/mm) - D	Collar: 21.9 (555) Can: 47.25 (1200)	Collar: 21.9 (555) Can: 47.25 (1200)	Collar: 21.9 (555) Can: 49.25 (1250)	Collar: 21.9 (555) Can: 49.25 (1250)
Buoy Height (in/mm) - H	68 (1745)	68 (1745)	50 (1270)	50 (1270)
Overall Height (in/mm) - O	68 (1745)	68 (1745)	68 (1727)	68 (1727)
Nominal Freeboard (in/mm) - F	49 (1244)	49 (1244)	46.5 (1181)	46.5 (1181)
Visual Area (ft ² /m ²)	8.1 (0.75)	8.1 (0.75)	8.6 (0.8)	8.6 (0.8)
Submergence (lb/in; kg/cm)	70 (12.5)	70 (12.5)	70 (12.5)	70 (12.5)
Nominal Draft (in/mm) - DR	15.75 (402)	15.75 (402)	21.5 (546)	21.5 (546)
Net weight (lb/kg)	313 (142)	313 (142)	154 (70)	154 (70)
Max Mooring Load (lb/kg)	172 (78)	172 (78)	342 (155)	342 (155)
Wall Thickness (in/mm)	Float collar: .375 (9) Can top: .25 (7)	Float collar: .375 (9) Can top: .25 (7)	Float collar: .375 (9) Can top: .25 (7)	Float collar: .375 (9) Can top: .25 (7)
Optional Solar Lantern (pgs. 16-17)	SL-15, SL-60, SL-70, SL-75	SL-15, SL-60, SL-70, SL-75	SL-15, SL-60, SL-70, SL-75	SL-15, SL-60, SL-70, SL-75

Solar LED Marine Lanterns—1-2NM & 2-3NM

Part # SL-15 1-2 Nautical Mile Lantern



Features of Sealite's SL-15 1-2NM Solar Marine Lanterns

- User-adjustable flash characters
- Automatic night activation
- NiMH battery for long service life and wide temperature range
- Completely sealed and self-contained using advanced UV-sealing
- Internal solar module
- Lens and base molded from UV-stabilized LEXAN® polycarbonate
- Installs in minutes and operates maintenance free for up to five years
- Waterproof (to IP68 standards)
- 100,000 hour life expectancy
- 3-year warranty

Options

- Available colors: red, green, yellow, white, blue
- ON/OFF switch for temporary installations
- IR remote

Part # SL-60 2-3 Nautical Mile Lantern

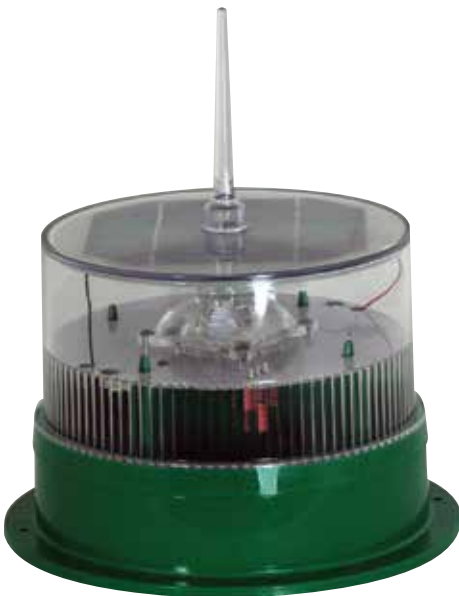

Features of Sealite's SL-60 2-3NM Solar Marine Lanterns

All of the SL-15 features plus:

- Detachable bird deterrent

Options

- GPS synchronization
- 200mm bolt pattern base
- Larger battery pack

Light Characteristics	SL-15	SL-60
Visible Range (NM) AT @ 0.85	1 - 2	1 - 3
Available Flash Characteristics	16 user-adjustable IALA flash characteristics (other flash patterns available on request)	Up to 256 IALA recommended (user adjustable)
Intensity Adjustments	Multiple Intensity Settings	Multiple Intensity Settings
Mounting	4x6mm mounting holes	4x4.5mm mounting holes
Height (in/mm)	5.5 (141)	8.125 (205)
Width (in/mm)	5.375 (136)	7 (177)
Weight (lbs/kg)	1.125 (0.5)	2.125 (0.9)

Solar LED Marine Lanterns—2-3NM & 3-5NM

Part # SL-70 2-3 Nautical Mile Lantern



Features of Sealite's SL-70 2-3NM Solar Marine Lanterns

- Reliable year-round operation in low sunlight conditions
- User-adjustable flash characters
- Dual internal high-performance solar modules
- NiMH battery for long service life and wide temperature range
- Large industry standard 200mm bolt pattern for ease of installation
- Lens and base molded from UV-stabilized LEXAN® polycarbonate
- Multiple intensity settings
- ON/OFF storage switch
- Waterproof (to IP68 standards)
- 100,000 hour life expectancy
- 3-year warranty

Options

- Available colors: red, green, yellow, white, blue
- IR remote
- GPS synchronization
- Larger battery pack

Part # SL-75 3-5 Nautical Mile Lantern

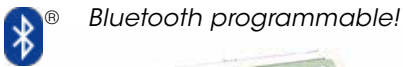

Features of Sealite's SL-75 3-5NM Solar Marine Lanterns

All of the above, plus:

- Bluetooth enabled for programming and maintenance
- Time efficiencies and increased safety are realized as diagnostics can be performed from safety of vessel without need to climb structures
- Meets USCG CFR 33 Parts 66 and 67

Options

- GPS synchronization
- GSM monitoring
- Large industry standard 200mm bolt pattern
- Larger battery pack
- Detachable bird deterrent

Light Characteristics	SL-70	SL-75
Visible Range (NM) AT @ 0.85	2 - 3	3 - 5
Available Flash Characteristics	Up to 256 IALA recommended (user adjustable)	310 plus custom character
Intensity Adjustments	Multiple Intensity Settings	Multiple Intensity Settings
Mounting	200mm bolt pattern	3 types: 3&4 hole 200mm bolt pattern, 3 hole 150mm bolt pattern, 4 hole 162mm bolt pattern
Height (in/mm)	9.5 (240)	12.375 (314)
Width (in/mm)	7.125 (231)	9.125 (231)
Weight (lbs/kg)	3.125 (1.4)	2.5 (5.5)

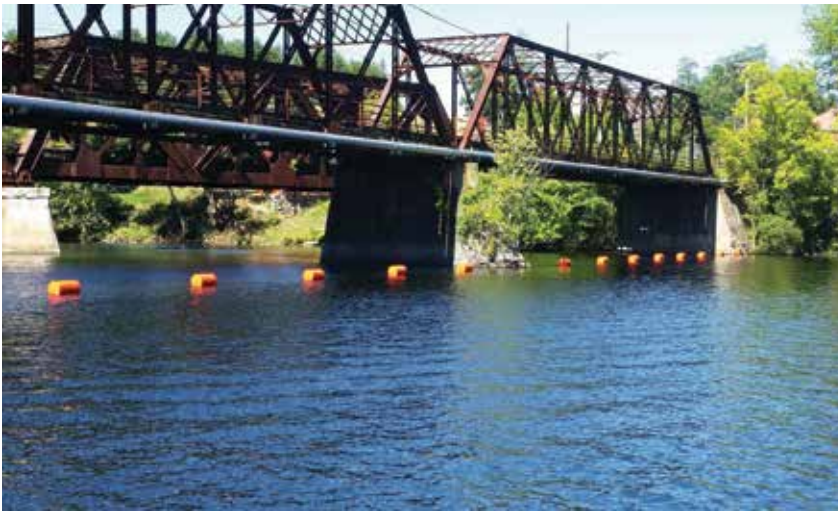

Features

- Integrated pipe thru design
- Rotationally molded single piece construction for strength and durability
- UV inhibited polyethylene for long lasting color retention
- 1-year warranty
- Standard color: International orange

Options

- Swivel ends
- Available colors: orange, green, yellow, white
- USCG approved retroreflective tape bands

SL-BF15-S
Shown with optional swivel ends
(available for all Barrier Floats)



SL-BF1830



SL-BF2436

Specifications	SL-BF15	SL-BF1830	SL-BF2436
Total Float Volume (gal/ltr)	7.5 (29)	26.5 (100)	56.5 (214)
Total Reserve Buoyancy (lb/kg)	53 (24)	174 (79)	370 (168)
Wall Thickness (in/mm)	0.2 (5)	0.2 (5)	0.2 (5)
Length (in/mm)	15 (382)	30 (762)	36 (914)
Diameter (in/mm)	15 (382)	18 (457)	24 (610)
Weight (lb/kg)	10 (4.5)	21 (9.5)	39 (17.5)

Size Guide for Barrier Floats

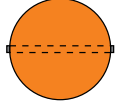
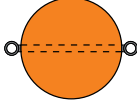
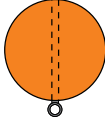
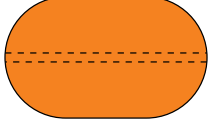
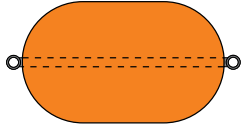
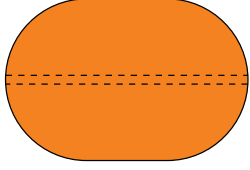
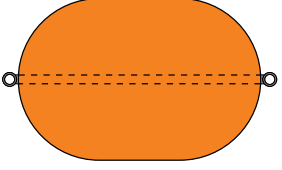
Model Number	Float Style	Dimensions	Description
SL-BF15		15" dia	3/4" galvanized pipe thru float
SL-BF15-S			5/8" galvanized rod thru float w/ swivels each end
SL-BF15-BE			5/8" galvanized rod thru float w/ eye one end
SL-BF1830		18" dia 30" length	1" HDPE pipe thru float
SL-BF1830-S			5/8" galvanized rod thru float w/ swivels both ends
SL-BF2436		24" dia 36" length	1" HDPE pipe thru float
SL-BF2436-S			5/8" galvanized rod thru float w/ swivels both ends

Two swivel ends with galvanized rod thru-float are available for each Sealite barrier float model.





Swim Areas

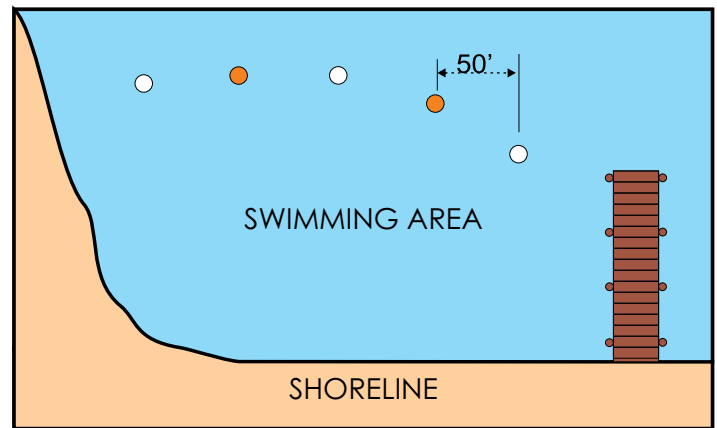
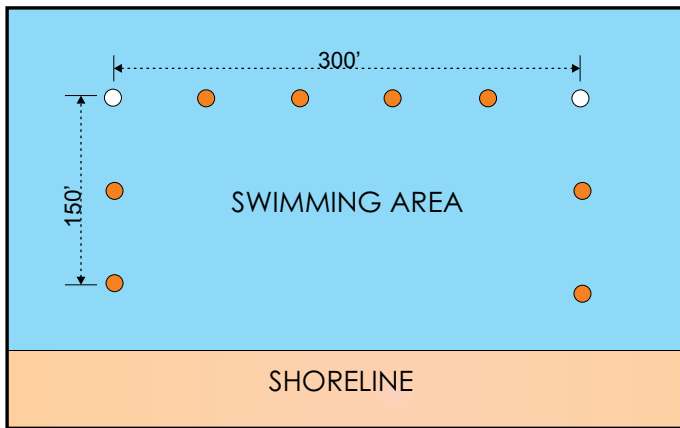

Dam Spillway

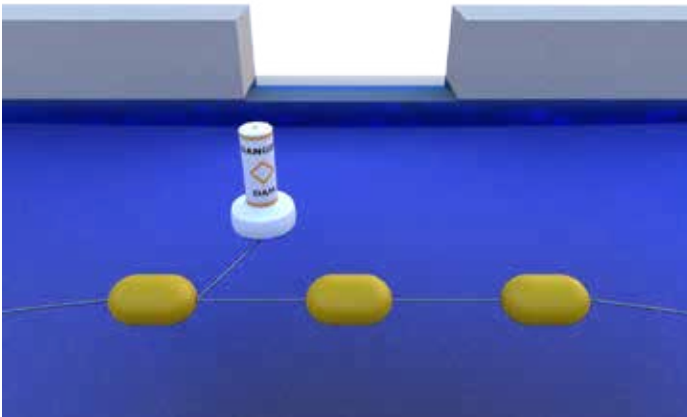

Construction Zone

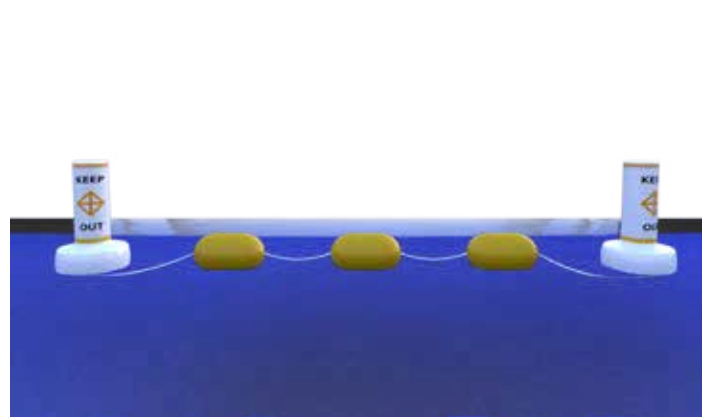

Additional Considerations for Mooring and Cable Selections:

- Is the barrier system being installed where floating debris may drag the floats or cable?
- Will seasonal conditions (flood, ice) affect the length or mooring loads required?
- Are wind loads going to be an occasional or constant factor at the installation site?

Mooring systems should exceed the breaking strength of the selected cable.

Daymarks & Signage

Channel Signs

Made from 1/8" aluminum. Powder coated flourescent background with 2" reflective border and reflective number.



Size	Part #
18" Green Square	SL-DM18-PH
24" Red Triangle	SL-DM24-SH
36" Green Square	SL-DM36-PH
48" Red Triangle	SL-DM48-SH

Warning Signs

Made from 1/8" aluminum. Includes white powder coated background as standard or optional reflective white background with 2" reflective border and black lettering.



Size/Type	Part #
24" x 24"	SL-DM24HAZ
24" x 24" Reflective	SL-DM24HAZ-R
36" x 36"	SL-DM36HAZ
36" x 36" Reflective	SL-DM36HAZ-R

Regulatory/Information Signs

Made from .080" aluminum. Includes white powder coated backing as standard or optional reflective white background with 3" reflective stripes and black lettering.

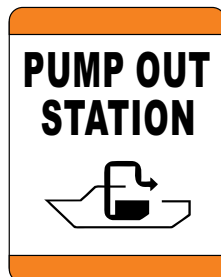
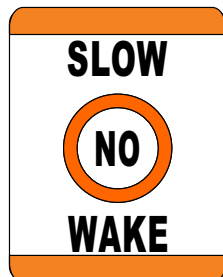
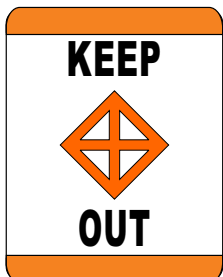

Size/Type	Part #
18" x 24"	SL-DM1824
18" x 24" Reflective	SL-DM1824-R
24" x 30"	SL-DM2430
24" x 30" Reflective	SL-DM2430-R

Mooring Buoys



Made in USA

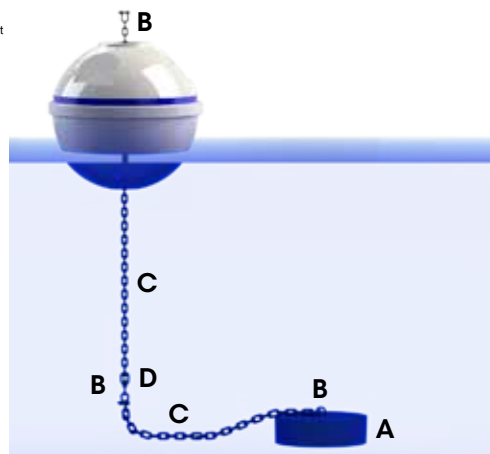
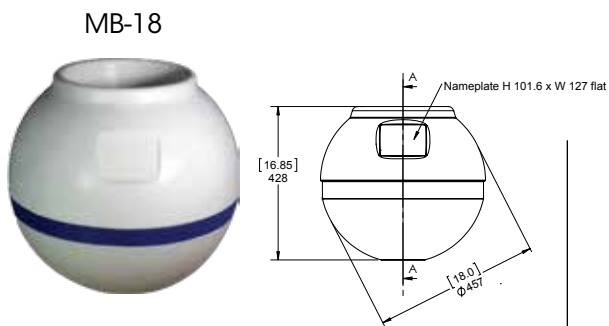
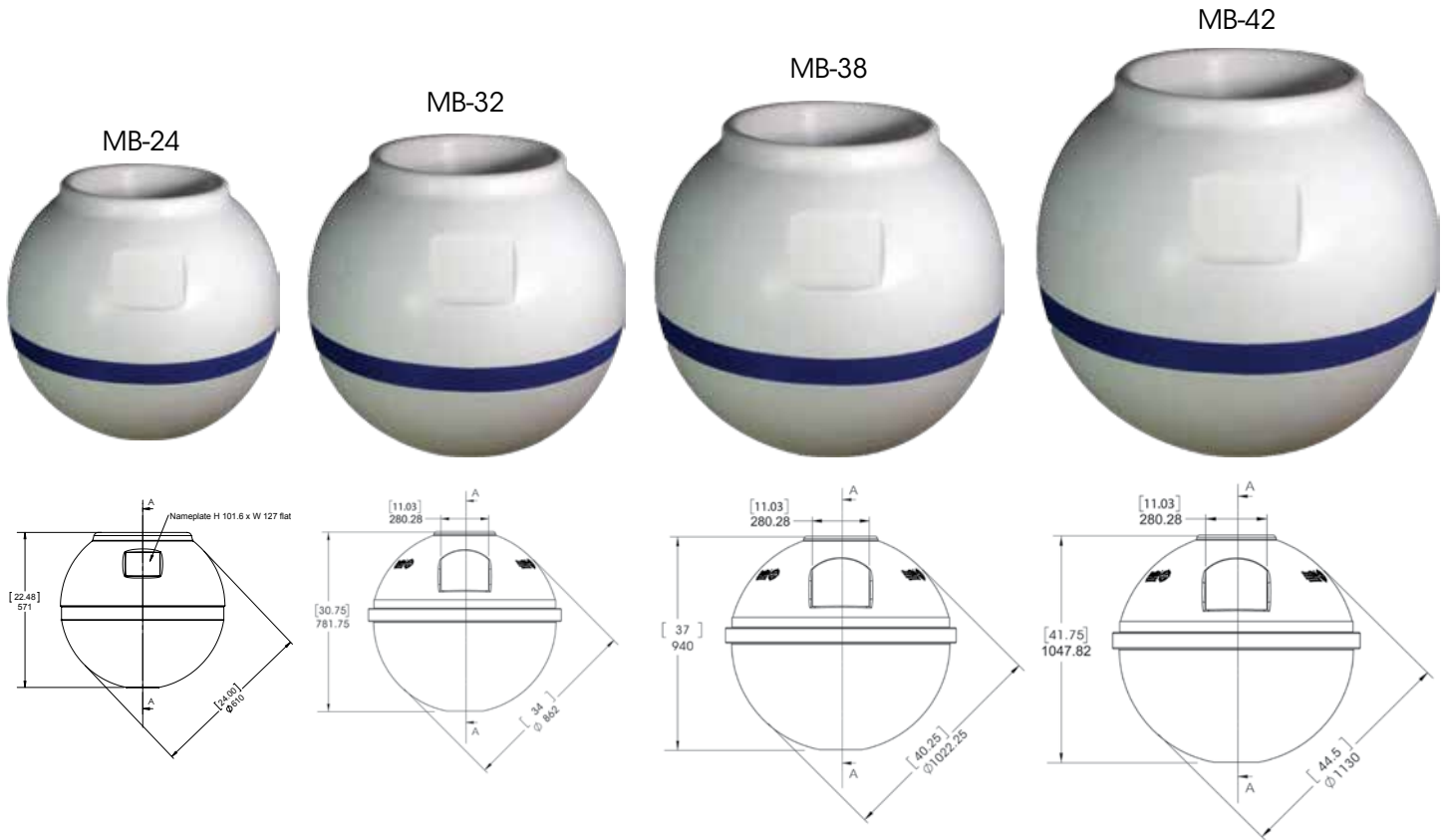

Mooring System	
A	Mooring Weight
B	Shackle
C	Chain
D	Swivel at buoy/chain connection point

Mooring accessories on pages 24-27

Specifications	MB-18	MB-24	MB-32	MB-38	MB-42	SL-WMS-36	SL-WMS-80
Height (in/mm)	16.8 (428)	22.5 (571)	30.75 (781.75)	37 (940)	41.75 (1048)	36 (914.5)	80 (2032)
Width (in/mm)	17.6 (446)	23.75 (601)	34 (862)	40.25 (1022.25)	44.5 (1130)	5 (127)	5 (127)
Weight (lbs/kg)	13 (6)	23 (10.5)	40 (18)	61 (27.5)	106 (48)	8 (3.5)	12 (5.5)
Max Mooring Load (lbs/kg)	36 (16.5)	23 (10.5)	230 (103.5)	486 (218.5)	614 (278.5)	15 (6.75)	30 (13.5)
Max Chain Size (in/mm)	3/8 (9.5)	5/8 (16)	5/8 (16)	5/8 (16)	5/8 (16)	5/8 (16)	5/8 (16)

Mooring Buoys continued...



Features

- Recessed shackle area insures boat scratching is virtually eliminated
- No cracking, chipping or fading as manufactured from UV inhibited polyethylene
- 1/4" thick to withstand challenging environmental conditions and heavy vessel traffic
- Closed cell polyurethane foam filling—virtually unsinkable
- Single piece rotationally molded construction for strength and durability
- Retroreflective blue tape
- Standard color: white

Options

- Nameplate customization
- Custom colors: red, green, yellow

Winter Mooring Sticks

- Integrated mooring eye at each end
- Easy access to mooring hardware and retrieval from icy water
- Blue retroreflective tape at top for visibility in slush and under ice
- Available in 2 sizes: 36-inch and 80-inch heights
- Made of virgin polyurethane for durability and long life in tough environmental conditions

SL-WMS-80
80-inches high

SL-WMS-36
36-inches high

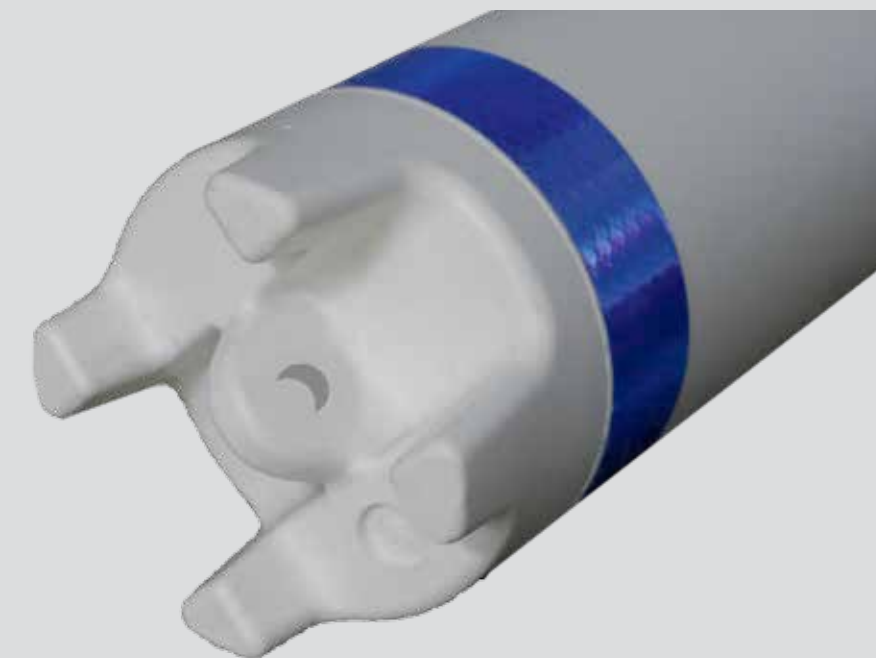

Blue retroreflective tape at top for visibility in slush and under ice

Elastic Conservation Mooring Solution*



Made in USA

Advantages over traditional ball and chain moorings

- Ecological alternative to ball/chain
- Increases mooring field density by 40%
- Protects seabed by eliminating chain drag on bottom surface
- Finfish/shellfish spawning areas; eel-grass, seabed, coral protection
- Gentler, more stable dock motion
- Elastic replaces chain, eliminating metal to metal mooring connections prone to rust/corrosion
- Quickly and easily connects at single point to mooring block
- Reduces load on deck hardware while holding mooring line taught
- Ideal for boats, aquaculture applications, docks, wave attenuators

Features

- Trawl floats help keep elastic strops off bottom
- Protects sea/river bottoms from mooring chain damage
- Increases mooring field density up to 40% as system can be installed with a scope as short as 1:1 (from mooring fields with boats on chain with 3:1 scope)
- Reduces point loads at connection locations (from deck cleat to anchor; from dock to anchor) by approximately 50%
- Suitable for boats with displacements from 4-35 tons
- Reduction in wind load as boats point better and more gently into the wind
- Ideal dock mooring solution: when installed at low tide/water, elastics taught; when tide-water rises, elastics stretch. The result is a more stable dock platform to walk on with more gentle float motion
- Black elastic rodes (made from UV inhibited cast polyurethane)
- Up to 15 years service life
- 2-year warranty

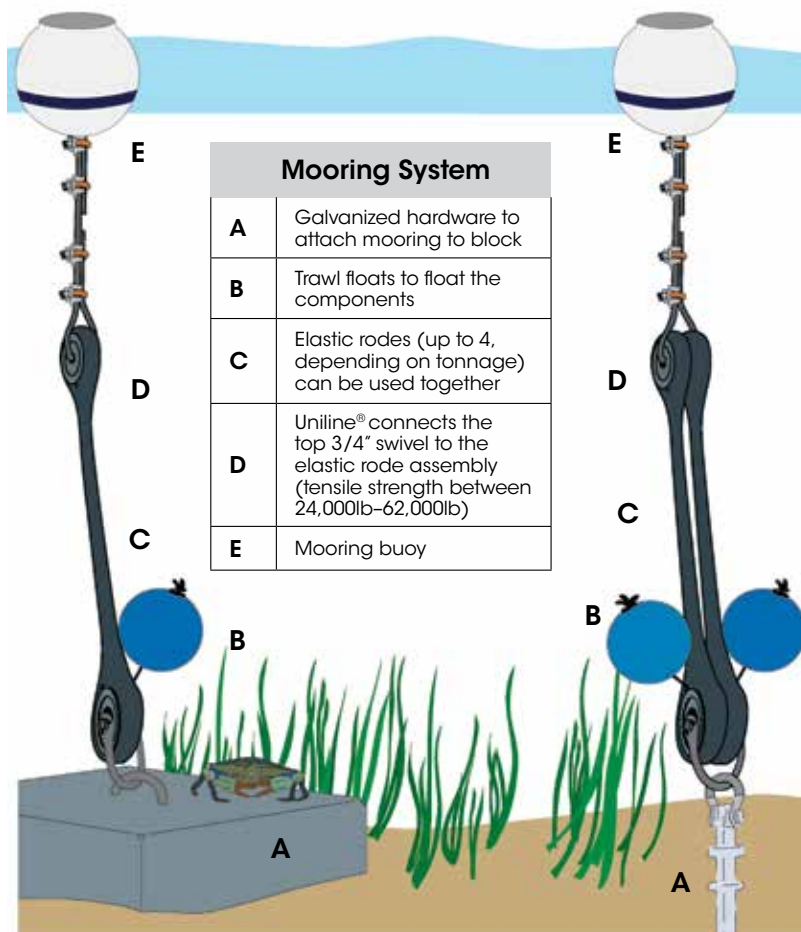

Options

- Varying lengths of elastic rodes available: 3', 6', 8', and 10' lengths
- Can easily be daisy-chained together to extend lengths for deepwater installations

Note: Variables (such as displacement, tide, current, depth, bottom structure, prevailing wind conditions) may influence number of recommended components.

Elastic Conservation Mooring Solution*

General Applications

- Mooring assemblies for boats from 4-35 tons
- Dive site moorings
- Mooring of choice for ecologically sensitive areas in salt or fresh waters
- Dock installations where pedestrian traffic needs safeguarding

Displacement	# of Required Elastic Rods
4-5 ton boats	Single rode
10-16 ton boats	Double rode
15-22 ton boats	Triple rode
25-35 ton boats	Quad rode

Increase mooring field size by 40%



Dock installation (right):

A more stable dock system results from the constantly taught mooring elastics while protecting the fragile sea/lake/river bed.

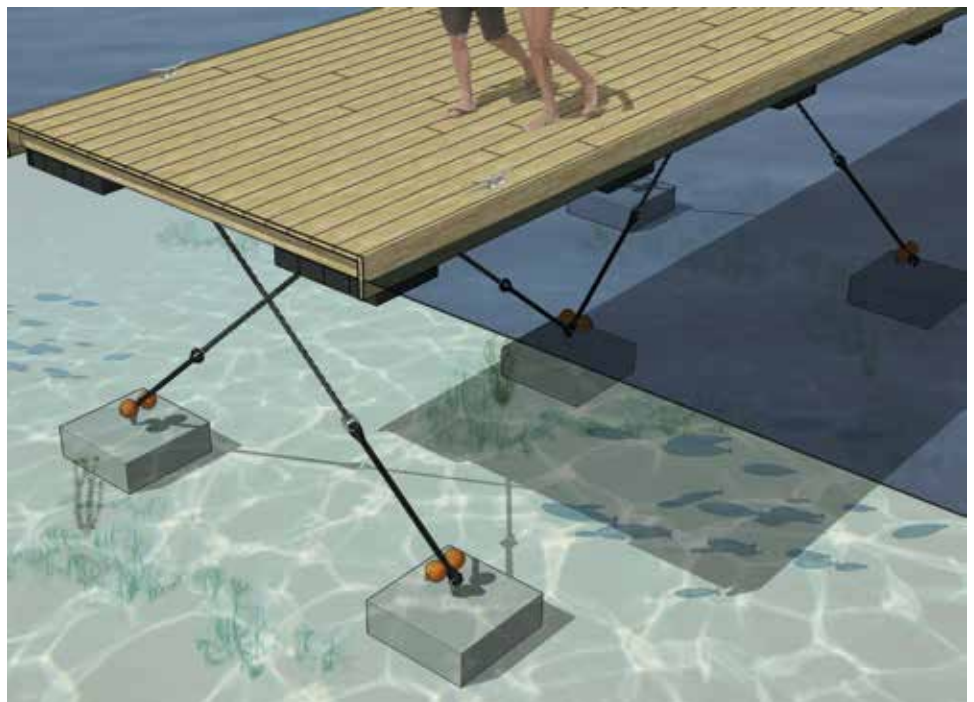

*Sealite is pleased to be a distributor for Hazelett Marine, manufacturer of the Conservation Mooring System.

Hazelett Marine

Conservation Elastic Mooring Systems - For Yachts, Docks, Wave Attenuators, Aquaculture Farms



High Strength Mooring Cable

Diameter	Part #	Construction	Weight (lb/ft)	Galvanized Breaking Strength (lb)	Stainless Breaking Strength (lb)
1/4"	M-CA-1/4	7 x 19	0.11	7,000	6,400
5/16"	M-CA-5/16	7 x 19	0.173	9,800	9,000
1/2"	M-CA-1/2	1 x 19	0.521	30,000	30,000
3/4"	M-CA-3/4	6 x 19	1.04	40,800	49,600

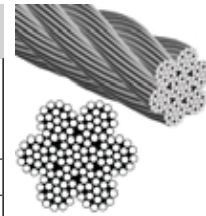

Mooring Chain

Size	Part #	Weight (lb/ft)	Working Load Limit (lb) Galvanized	Working Load Limit (lb) Stainless
3/8"	M-CH-3/8X	0.146	4,050	5,000
1/2"	M-CH-1/2X	0.255	6,900	8,667
5/8"	M-CH-5/8X	0.378	9,750	
3/4"	M-CH-3/4X	0.528	11,600	



Swivels

Size	Part #
1/4"	M-SW-1/4X
5/16"	M-SW-5/16X
3/8"	M-SW-3/8X
1/2"	M-SW-1/2X
3/4"	M-SW-3/4X
1"	M-SW-1X

Shackles

Size	Part #
5/16"	M-SH-5/16X
3/8"	M-SH-3/8X
1/2"	M-SH-1/2X
3/4"	M-SH-3/4X
1"	M-SH-1X



Thimbles

Size	Part #
1/4"	M-TH-1/4X
5/16"	M-TH-5/16X
1/2"	M-TH-1/2X
3/4"	M-TH-3/4X



Cable Clamps

Size	Part #
1/4"	M-CL-1/4X
5/16"	M-CL-5/16X
3/8"	M-CL-3/8X
1/2"	M-CL-1/2X
3/4"	M-CL-3/4X



Uniline

Size	Part #	Weight (lb/ft)	Breaking Strength (lb)
3/8"	M-U-3/8	0.07	6,000
1/2"	M-U-1/2	0.1	10,500



Quick Links

Size	Part #
1/4"	M-QL-1/4X
3/8"	M-QL-3/8X
1/2"	M-QL-1/2X



X = G - galvanized
SS - stainless steel

Uniline: easier to use, lighter, and longer lasting alternative to cable for mooring smaller navigational aids

- Parallel-core cable of PET (polyester) filament bonded together with a rubber-based adhesive, wrapped with red rubber tape, over-braided with a tough polyester sleeve, and entirely saturated with another rubber solution
- Cured in an oven, causing the rubber to become a solid layer with impressive abrasion resistance
- Treated like a cable with cable clamps securing it to buoy
- Incredible wear characteristics
- After 20 years of service, tested at 90% of breaking strength of new cable
- Easier to handle when installing/removing

Mooring Weights

SL-MW-75

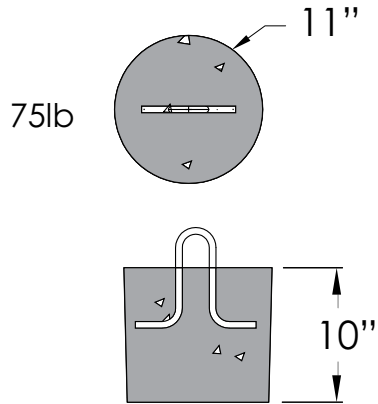

SL-MW-600

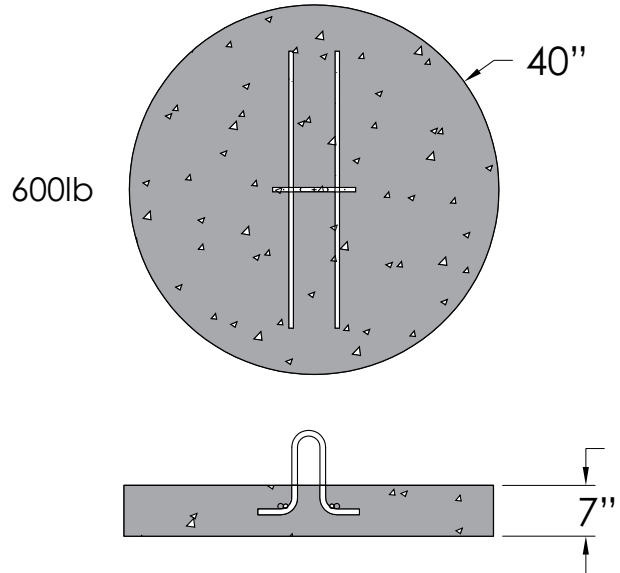

SL-MW-150

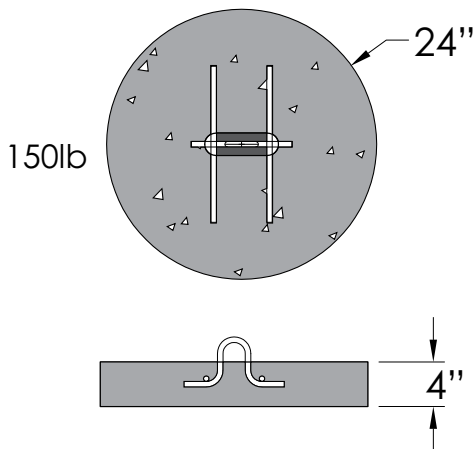

SL-MW-KIT

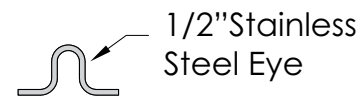

SL-MW-250

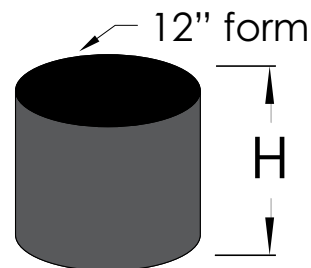
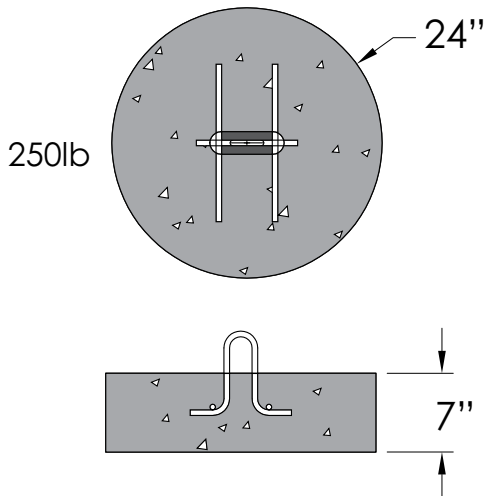

Mooring Kit Specifications

Diameter (in)	Height (H)	Filled Weight (lb)
12	10	75
12	14	105
12	18	135



Sealite USA, LLC
61 Business Park Drive
Tilton, New Hampshire 03276

No matter the marine application, Sealite can provide a marking solution to fit your specific need while meeting all federal, state, and municipal requirements/regulations. Our customers are some of the most demanding in the world, including the U.S. Armed Forces (Navy, Air Force, Coast Guard, Army), international conservation groups, state park departments, state police, and sheriff departments. Trust your marking requirements to Sealite.



V17-1

All specifications are subject to change without notice.



Sealite[®]

www.sealite.com

Sealite USA, LLC
61 Business Park Drive
Tilton, New Hampshire 03276
USA

t: +1 (603) 737 1311

f: +1 (603) 737 1320

w: www.sealite.com
e: info@sealiteusa.com

State of Nebraska - INVITATION TO BID CONTRACT

Return to:
State Purchasing Bureau
1526 K Street, Suite 130
Lincoln, Nebraska 68508
Telephone: 402-471-6500
Fax: 402-471-2089

Date	6/28/17	Page	1 of 2
Solicitation Number	5628 OF		
Opening Date and Time	08/01/17	2:00 pm	
Buyer	KRISTEN KOSCH (AS)		

DESTINATION OF GOODS

GAME & PARKS COMMISSION
PAWNEE SRA
C/O PARK SUP'T
3800 NW 105TH ST
LINCOLN NE 68524-8816

Per Nebraska's Transparency in Government Procurement Act, DAS is required to collect statistical information regarding the number of contracts awarded to Nebraska contractors. This information is for statistical purposes only and will not be considered for contract award purposes.

____ NEBRASKA CONTRACTOR AFFIDAVIT: Bidder hereby attests that bidder is a Nebraska Contractor. "Nebraska Contractor" shall mean any bidder who has maintained a bona fide place of business and at least one employee within this state for at least the six (6) months immediately preceding the posting date of this ITB.

____ I hereby certify that I am a Resident disabled veteran or business located in a designated enterprise zone in accordance with Neb. Rev. Stat. §73-107 and wish to have preference, if applicable, considered in the award of this contract.

Contract to supply and deliver Can Buoys to the State of Nebraska as per the attached specifications for a one (1) year period from date of award. The contract may be renewed for four (4) additional one (1) year periods when mutually agreeable to the vendor and the State of Nebraska.

(vc 06/12/17)

INVITATION

CORE PRODUCT

Line	Description	Quantity	Unit of Measure	Unit Price	Extended Price
1	CAN BUOY 12X51 Make: Rolyan Model: B1251	200.0000	EA	\$214.00	\$42,800

CATALOG/NON-CORE CATEGORIES

2	REGULATORY BUOYS (EXCLUDING ROLYAN CAN BUOYS)			30%	% discount
3	FLOAT COLLAR CANS			30%	% discount
4	GREEN CHANNEL MARKERS			30%	% discount

BIDDER MUST COMPLETE THE FOLLOWING

DISCOUNT PAYMENT TERMS: 0 % 30 DAYS

By signing this Invitation to Bid form, the bidder guarantees compliance with the provisions stated in this Invitation to Bid, agrees to the terms and conditions unless otherwise agreed to (see Section III) and certifies that bidder maintains a drug free work place environment. **Vendor will furnish 100 of the items requested within 30 days after receipt of initial order, with balance of 100 within 60 days after receipt of initial order.** Failure to enter Delivery Date may cause quotation to be REJECTED.

Sign Tara Stewart President

Enter Contact Information Below

Here (Authorized Signature MANDATORY - MUST BE SIGNED IN INK)

VENDOR# 2359922
VENDOR: Sealite USA, LLC
Address: 61 Business Park Drive
Tilton, New Hampshire 03276

Contact: Tara Stewart
Telephone: 603 737 1317
Facsimile: 603 737 1320
Email: t.stewart@sealite.com

State of Nebraska - INVITATION TO BID CONTRACT

Return to:
State Purchasing Bureau
1526 K Street, Suite 130
Lincoln, Nebraska 68508

Telephone: 402-471-6500
Fax: 402-471-2089

Date	6/28/17	Page	2 of 2
Solicitation Number	5628 OF		
Opening Date and Time	08/01/17	2:00 pm	
Buyer	KRISTEN KOSCH (AS)		

DESTINATION OF GOODS

GAME & PARKS COMMISSION
PAWNEE SRA
C/O PARK SUP'T
3800 NW 105TH ST
LINCOLN NE 68524-8816

INVITATION

Line	Description	Quantity	Unit of Measure	Unit Price	Extended Price
5	RED CHANNEL MARKERS			<u>30%</u> % discount	
6	HARDWARE (INCLUDES CABLE CHAIN AND FASTERS)			<u>30%</u> % discount	
7	RESTORATION MATERIALS			<u>30%</u> %discount	
8	ANY OTHER MARINE PRODUCTS AVAILABLE			<u> </u> % discount	

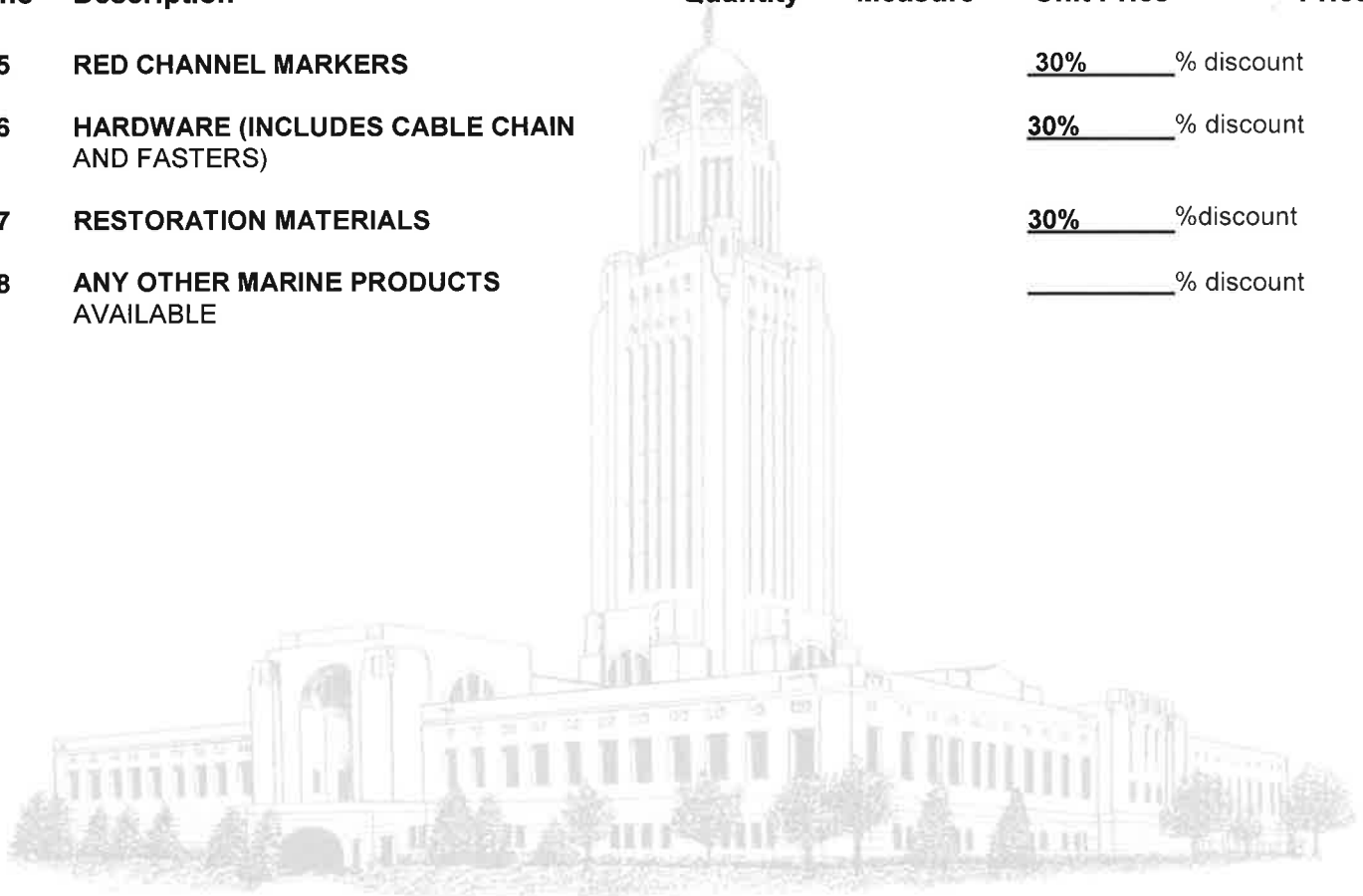

INVITATION TO BID

Number-5628-OF

The State of Nebraska (State), Department of Administrative Services (DAS), Materiel Division, State Purchasing Bureau (SPB), is issuing this Invitation to Bid (ITB) for a commodity contract, ITB Number 5628 OF for the purpose of selecting a qualified Bidder to provide Can Buoys. Specifications can be found in Section V and VI. The resulting contract may not be an exclusive contract as the State reserves the right to contract for the same or similar goods from other sources now or in the future.

The term of the contract will be one (1) years commencing upon execution of the contract by the State and the Bidder notice to proceed. The Contract includes the option to renew for four (4) additional one (1) year periods upon mutual agreement of the Parties. The State reserves the right to extend the period of this contract beyond the termination date when mutually agreeable to the Parties.

INFORMATION PERTINENT TO THIS INVITATION TO BID CAN BE FOUND ON THE INTERNET AT:

<http://das.nebraska.gov/materiel/purchasing.html>.

IMPORTANT NOTICE: Pursuant to Neb. Rev. Stat. § 84-602.02, State contracts in effect as of January 1, 2014, and contracts entered into thereafter, must be posted to a public website. The resulting contract, the ITB, and the successful Bidder's bid or response will be posted to a public website managed by DAS, which can be found at:

<https://statecontracts.nebraska.gov/>

In addition and in furtherance of the State's public records statute (Neb. Rev. Stat. § 84-712 et seq.) all bids or responses received regarding this ITB will be posted to the SPB website.

These postings will include the entire bid or response. Bidders must request that proprietary information be excluded from the posting. The Bidder must identify the proprietary information, mark the proprietary information according to state law, and submit the proprietary information in a separate container or envelope marked conspicuously using an indelible method with the words "PROPRIETARY INFORMATION". The Bidder must submit a **detailed written document showing** that the release of the proprietary information would give a business advantage to named business competitor(s) and explain how the named business competitor(s) will gain an actual business advantage by disclosure of information. The mere assertion that information is proprietary or that a speculative business advantage might be gained is not sufficient. (See Attorney General Opinion No. 92068, April 27, 1992) **THE BIDDER MAY NOT ASSERT THAT THE ENTIRE BID OR RESPONSE IS PROPRIETARY. COST WILL NOT BE CONSIDERED PROPRIETARY AND IS A PUBLIC RECORD IN THE STATE OF NEBRASKA.** The State will then determine, in its discretion, if the interests served by nondisclosure outweighs any public purpose served by disclosure. (See Neb. Rev. Stat. § 84-712.05(3)) The Bidder will be notified of the agency's decision. Absent a State determination that information is proprietary, the State will consider all information a public record subject to release regardless of any assertion that the information is proprietary.

If the agency determines it is required to release proprietary information, the Bidder will be informed. It will be the Bidder's responsibility to defend the Bidder's asserted interest in non-disclosure.

To facilitate such public postings, with the exception of proprietary information, the State of Nebraska reserves a royalty-free, nonexclusive, and irrevocable right to copy, reproduce, publish, post to a website, or otherwise use any contract, bid, or response to this ITB for any purpose, and to authorize others to use the documents. Any individual or entity awarded a contract, or who submits a bid or response to this ITB, specifically waives any copyright or other protection the contract, bid, or response to the ITB may have; and, acknowledges that they have the ability and authority to enter into such waiver. This reservation and waiver is a prerequisite for submitting a bid or response to this ITB, and award of a contract. Failure to agree to the reservation and waiver will result in the bid or response to the ITB being found non-responsive and rejected.

Any entity awarded a contract or submitting a bid or response to the ITB agrees not to sue, file a claim, or make a demand of any kind, and will indemnify and hold harmless the State and its employees, volunteers, agents, and its elected and appointed officials from and against any and all claims, liens, demands, damages, liability, actions, causes of action, losses, judgments, costs, and expenses of every nature, including investigation costs and expenses, settlement costs, and attorney fees and expenses, sustained or asserted against the State, arising out of, resulting from, or attributable to the posting of the contract or the bids and responses to the ITB, awards, and other documents.

TABLE OF CONTENTS

INVITATION TO BID.....	i
TABLE OF CONTENTS	ii
GLOSSARY OF TERMS.....	iv
I. PROCUREMENT PROCEDURE	8
A. GENERAL INFORMATION	8
B. PROCURING OFFICE AND COMMUNICATION WITH STATE STAFF AND EVALUATORS.....	8
C. COMMUNICATION WITH STATE STAFF.....	8
D. SCHEDULE OF EVENTS.....	8
E. RECYCLING (§ 81-15,159(d)(2))	9
F. SECRETARY OF STATE/TAX COMMISSIONER REGISTRATION REQUIREMENTS (Statutory).....	9
G. ETHICS IN PUBLIC CONTRACTING.....	9
H. SPECIFICATIONS.....	9
I. SAMPLES.....	9
J. BID PREPARATION COSTS.....	9
K. DISCOUNTS	9
L. PRICES	9
M. DEVIATIONS FROM THE INVITATION TO BID	10
N. VALID BID TIME.....	10
O. LUMP SUM OR 'ALL OR NONE' BIDS.	10
P. BID REQUIREMENTS.....	10
Q. FAILURE TO COMPLY WITH INVITATION TO BID	10
R. SUBMISSION OF BIDS.....	10
S. EMAIL SUBMISSIONS.....	11
T. BID CORRECTIONS	11
U. LATE BIDS	11
V. BID OPENING	11
W. BID TABULATIONS.....	11
X. BEST AND FINAL OFFER	11
Y. REFERENCE AND CREDIT CHECKS	11
Z. REJECTION OF BIDS.....	11
AA. RESIDENT BIDDER.....	11
BB. AWARD	11
II. TERMS AND CONDITIONS	13
A. GENERAL	13
B. NOTIFICATION	13
C. GOVERNING LAW.....	14
D. BEGINNING OF WORK.	14
E. The Contractor shall not commence any billable work until a valid contract has been fully executed by the State and the successful Contractor. CHANGE ORDERS OR SUBSTITUTIONS.....	14
F. BREACH.....	15
G. NON-WAIVER OF BREACH	15
H. SEVERABILITY	15
I. INDEMNIFICATION.....	16
J. ATTORNEY'S FEES.....	16
K. ASSIGNMENT, SALE, OR MERGER.....	16
L. CONTRACTING WITH OTHER POLITICAL SUB-DIVISIONS OF THE STATE OR ANOTHER STATE	17
M. FORCE MAJEURE.....	17
N. CONFIDENTIALITY.....	17
O. EARLY TERMINATION	18
P. CONTRACT CLOSEOUT	18
III. CONTRACTOR DUTIES	20
A. INDEPENDENT CONTRACTOR / OBLIGATIONS.....	20
B. EMPLOYEE WORK ELIGIBILITY STATUS.....	20
C. COMPLIANCE WITH CIVIL RIGHTS LAWS AND EQUAL OPPORTUNITY EMPLOYMENT / NONDISCRIMINATION (Statutory).....	21
D. COOPERATION WITH OTHER CONTRACTORS	21

E.	PERMITS, REGULATIONS, LAWS.....	21
F.	NOTICE OF POTENTIAL CONTRACTOR BREACH.....	22
G.	ANTITRUST.....	22
H.	CONFLICT OF INTEREST.....	22
I.	ADVERTISING.....	23
J.	DRUG POLICY.....	23
IV.	PAYMENT.....	24
A.	PROHIBITION AGAINST ADVANCE PAYMENT.....	24
B.	TAXES.....	24
C.	INVOICES.....	24
D.	INSPECTION AND APPROVAL.....	24
E.	PAYMENT (Statutory).....	25
F.	LATE PAYMENT (Statutory).....	25
G.	SUBJECT TO FUNDING / FUNDING OUT CLAUSE FOR LOSS OF APPROPRIATIONS (Statutory).....	25
H.	RIGHT TO AUDIT (Statutory).....	25
V.	SCOPE OF WORK.....	26
A.	SCOPE.....	26
B.	AMENDMENT.....	26
C.	REVISIONS.....	26
VI.	INVITATION TO BID - TECHNICAL SPECIFICATIONS.....	27
A.	BIDDER INSTRUCTIONS.....	27
B.	NON-COMPLIANCE STATEMENT.....	27
C.	CAN BUOYS.....	27
D.	ACCEPTABLE BRANDS.....	28
E.	ANNUAL USAGE, ESTIMATED.....	29
F.	USAGE REPORT.....	29
G.	DELIVERY ARO.....	29
H.	DELIVER LOCATIONS/INSTRUCTIONS (BIDDER IS CERTIFYING THAT THEY CAN MEET THE DELIVER LOCATIONS/INSTRUCTIONS).....	30
I.	PACKAGING.....	30
J.	ORDERS.....	30
K.	QUALITY.....	30
L.	AUTHORIZED DEALER & WARRANTY.....	31
M.	WARRANTY.....	32
N.	SUBSTITUTIONS.....	32
O.	SECRETARY OF STATE REGISTRATION REQUIREMENTS.....	33
	Form A Bidder Contact Sheet.....	34

GLOSSARY OF TERMS

Acceptance Test Procedure: Benchmarks and other performance criteria, developed by the State or other sources of testing standards, for measuring the effectiveness of products or goods and the means used for testing such performance.

Addendum: Something to be added or deleted to an existing document; a supplement.

After Receipt of Order (ARO): After Receipt of Order

Agency: Any state agency, board, or commission other than the University of Nebraska, the Nebraska State colleges, the courts, the Legislature, or any other office or agency established by the Constitution of Nebraska.

Agent/Representative: A person authorized to act on behalf of another.

Amend: To alter or change by adding, subtracting, or substituting.

Amendment: A written correction or alteration to a document.

Appropriation: Legislative authorization to expend public funds for a specific purpose. Money set apart for a specific use.

Award: All purchases, leases, or contracts which are based on competitive bids will be awarded according to the provisions in the ITB. The State reserves the right to reject any or all bids, wholly or in part, or to award to multiple Bidders in whole or in part. The State reserves the right to waive any deviations or errors that are not material, do not invalidate the legitimacy of the bid, and do not improve the Bidder's competitive position. All awards will be made in a manner deemed in the best interest of the State.

Bid: The offer submitted by a vendor in a response to written solicitation.

Bid Bond: An insurance agreement, accompanied by a monetary commitment, by which a third party (the surety) accepts liability and guarantees that the vendor will not withdraw the bid.

Bidder: A vendor who submits an offer bid in response to a written solicitation.

Business: Any corporation, partnership, individual, sole proprietorship, joint-stock company, joint venture, or any other private legal entity.

Business Day: Any weekday, except State-recognized holidays.

Calendar Day: Every day shown on the calendar including Saturdays, Sundays, and State/Federal holidays.

Cancellation: To call off or revoke a purchase order without expectation of conducting or performing it at a later time.

Central Processing Unit (CPU): Any computer or computer system that is used by the State to store, process, or retrieve data or perform other functions using Operating Systems and applications software.

Change Order: Document that provides amendments to an executed purchase order.

Collusion: An agreement or cooperation between two or more persons or entities to accomplish a fraudulent, deceitful, or unlawful purpose.

Commodities: Any equipment, material, supply or goods; anything movable or tangible that is provided or sold.

Commodities Description: Detailed descriptions of the items to be purchased; may include information necessary to obtain the desired quality, type, color, size, shape, or special characteristics necessary to perform the work intended to produce the desired results.

Competition: The effort or action of two or more commercial interests to obtain the same business from third parties.

Confidential Information: Unless otherwise defined below, "Confidential Information" shall also mean proprietary trade secrets, academic and scientific research work which is in progress and unpublished, and other information which if released would give advantage to business competitors and serve no public purpose (see Neb. Rev. Stat. §84-712.05(3)). In accordance with Nebraska Attorney General Opinions 92068 and 97033, proof that information is proprietary requires identification of specific, named competitor(s) who would be advantaged by release of the information and the specific advantage the competitor(s) would receive.

Contract: An agreement between two or more parties creating obligations that are enforceable or otherwise recognizable at law; the writing that sets forth such an agreement.

Contract Administration: The management of the contract which includes and is not limited to contract signing, contract amendments

and any necessary legal actions.

Contract Management: The management of day to day activities at the agency which includes and is not limited to ensuring deliverables are received, specifications are met, handling meetings and making payments to the Contractor.

Contract Period: The duration of the contract.

Contractor: Any individual or entity having a contract or awarded purchase order to furnish commodities or goods.

Cooperative Purchasing: The combining of requirements of two or more political entities to obtain advantages of volume purchases, reduction in administrative expenses or other public benefits.

Copyright: A property right in an original work of authorship fixed in any tangible medium of expression, giving the holder the exclusive right to reproduce, adapt and distribute the work.

Critical Program Error: Any Program Error, whether or not known to the State, which prohibits or significantly impairs use of the Licensed Software as set forth in the documentation and intended in the contract.

Customer Service: The process of ensuring customer satisfaction by providing assistance and advice on those products or goods provided by a Contractor.

Default: The omission or failure to perform a contractual duty.

Deviation: Any proposed change(s) or alteration(s) to either the terms and conditions or deliverables within the scope of the written solicitation or contract.

Evaluation: The process of examining an offer after opening to determine the vendor's responsibility, responsiveness to requirements, and to ascertain other characteristics of the offer that relate to determination of the successful award.

Evaluation Committee: Committee(s) appointed by the requesting agency that advises and assists the procuring office in the evaluation of bids/s (offers made in response to written solicitations).

Extension: Continuance of a contract for a specified duration upon the agreement of the parties beyond the original Contract Period. Not to be confused with "Renewal Period".

Free on Board (F.O.B.) Destination: The delivery charges are included in the quoted price and prepaid by the vendor. Vendor is responsible for all claims associated with damages during delivery of product.

Free on Board (F.O.B.) Point of Origin: The delivery charges are not included in the quoted price and are the responsibility of the agency. Agency is responsible for all claims associated with damages during delivery of product.

Foreign Corporation: A foreign corporation that was organized and chartered under the laws of another state, government, or country.

Installation Date: The date when the procedures described in "Installation by Contractor", and "Installation by State", as found in the ITB, ITB (written solicitation) or contract are completed.

Invalid Bid: i.e., a fax or email response for a term contract.

Late Bid: An offer received after the Opening Date and Time.

Licensed Software Documentation: The user manuals and any other materials in any form or medium customarily provided by the Contractor to the users of the Licensed Software which will provide the State with sufficient information to operate, diagnose, and maintain the Licensed Software properly, safely, and efficiently.

Mandatory/Must: Required, compulsory, or obligatory.

May: Discretionary, permitted; used to express possibility.

Module (see System): A collection of routines and data structures that perform a specific function of software.

Must: See Shall/Will/Must.

National Institute for Governmental Purchasing (NIGP): National Institute of Governmental Purchasing – Source used for assignment of universal commodity codes to goods and goods.

Open Market Purchase: Authorization may be given to an agency to purchase items above direct purchase authority due to the unique nature, price, quantity, location of the using agency, or time limitations by the AS Materiel Division, State Purchasing Bureau.

Opening Date and Time: Specified date and time for the public opening of received, labeled, and sealed formal bids.

Operating System: The control program in a computer that provides the interface to the computer hardware and peripheral devices, and the usage and allocation of memory resources, processor resources, input/output resources, and security resources.

Outsourcing: The contracting out of a business process which an organization may have previously performed internally or has a new need for, to an independent organization from which the process is purchased back.

Payroll & Financial Center (PFC): Electronic procurement system of record.

Performance Bond: An insurance agreement, accompanied by a monetary commitment, by which a third party (the surety) accepts liability and guarantees that the Contractor fulfills any and all obligations under the contract.

Platform: A specific hardware and Operating System combination that is different from other hardware and Operating System combinations to the extent that a different version of the Licensed Software product is required to execute properly in the environment established by such hardware and Operating System combination.

Point of Contact (POC): The person designated to receive communications and to communicate

Pre-Bid/Pre-Proposal Conference: A meeting scheduled for the purpose of clarifying a written solicitation and related expectations.

Product: Something that is distributed commercially for use or consumption and that is usually (1) tangible personal property, (2) the result of fabrication or processing, and (3) an item that has passed through a chain of commercial distribution before ultimate use or consumption.

Program Error: Code in Licensed Software which produces unintended results or actions, or which produces results or actions other than those described in the specifications. A program error includes, without limitation, any Critical Program Error.

Program Set: The group of programs and products, including the Licensed Software specified in the ITB, plus any additional programs and products licensed by the State under the contract for use by the State.

Project: The total scheme, program, or method worked out for the accomplishment of an objective, including all documentation, commodities, and goods to be provided under the contract.

Proposal: See Bid.

Proprietary Information: Proprietary information is defined as trade secrets, academic and scientific research work which is in progress and unpublished, and other information which if released would give advantage to business competitors and service no public purpose (see Neb. Rev. Stat. § 84-712.05(3)). In accordance with Attorney General Opinions 92068 and 97033, proof that information is proprietary requires identification of specific named competitor(s) advantaged by release of the information and the demonstrated advantage the named competitor(s) would gain by the release of information.

Protest/Grievance: A complaint about a governmental action or decision related to an ITB or resultant contract, brought by a vendor who has timely submitted a bid response in connection with the award in question, to AS Materiel Division or another designated agency with the intention of achieving a remedial result.

Public Bid Opening: The process of opening correctly submitted offers at the time and place specified in the written solicitation and in the presence of anyone who wished to attend.

Recommended Hardware Configuration: The data processing hardware (including all terminals, auxiliary storage, communication, and other peripheral devices) to the extent utilized by the State as recommended by the Contractor.

Release Date: The date of public release of the written solicitation to seek offers

Renewal Period: Optional contract periods subsequent to the original Contract Period for a specified duration with previously agreed to terms and conditions. Not to be confused with Extension.

Request for Information (RFI): A general invitation to vendors requesting information for a potential future solicitation. The RFI is typically used as a research and information gathering tool for preparation of a solicitation.

Invitation to Bid (ITB): A written solicitation utilized for obtaining competitive offers.

Responsible Bidder: A Bidder who has the capability in all respects to perform fully and lawfully all requirements with integrity and reliability to assure good faith performance.

Responsive Bidder: A Bidder who has submitted a bid which conforms to all requirements of the solicitation document.

Shall/Will/Must: An order/command; mandatory.

Should: Expected; suggested, but not necessarily mandatory.

Software License: Legal instrument with or without printed material that governs the use or redistribution of licensed software.

Sole Source – Commodity: When an item is available from only one source due to the unique nature of the requirement, its supplier, or market conditions.

Sole Source – Service: A service of such a unique nature that the vendor selected is clearly and justifiably the only practical source to provide the service. Determination that the vendor selected is justifiably the sole source is based on either the uniqueness of the service or sole availability at the location required.

Specifications: The detailed statement, especially of the measurements, quality, materials, and functional characteristics, or other items to be provided under a contract.

System (see Module): Any collection or aggregation of two (2) or more Modules that is designed to function, or is represented by the Contractor as functioning or being capable of functioning, as an entity.

Termination: Occurs when the contract expires or either party, pursuant to a power created by agreement or law puts an end to the contract prior to the stated expiration date. All obligations which are still executory on both sides are discharged but any right based on prior breach or performance survives.

Trade Secret: Information, including, but not limited to, a drawing, formula, pattern, compilation, program, device, method, technique, code, or process that (a) derives independent economic value, actual or potential, from not being known to, and not being ascertainable by proper means by, other persons who can obtain economic value from its disclosure or use; and (b) is the subject of efforts that are reasonable under the circumstances to maintain its secrecy (see Neb. Rev. Stat. §87-502(4)).

Trademark: A word, phrase, logo, or other graphic symbol used by a manufacturer or vendor to distinguish its product from those of others, registered with the U.S. Patent and Trademark Office.

Upgrade: Any change that improves or alters the basic function of a product of service.

Vendor: An individual or entity lawfully conducting business in the State, or licensed to do so, who seeks to provide goods or goods under the terms of a written solicitation.

Vendor Performance Report: A report issued to the Contractor by SPB when products or goods delivered or performed fail to meet the terms of the purchase order, contract, and/or specifications, as reported to SPB by the agency. The SPB shall contact the Contractor regarding any such report. The vendor performance report will become a part of the permanent record for the Contractor. The State may require vendor to cure. Two such reports may be cause for immediate termination.

Will: See Shall/Will/Must.

Work Day: See Business Day.

I. PROCUREMENT PROCEDURE

A. GENERAL INFORMATION

The ITB is designed to solicit bids from qualified Bidders who will be responsible for providing Can Buoys at a competitive and reasonable cost. A detailed description can be found in Section VI.

Bids shall conform to all instructions, conditions, and requirements included in the ITB. Prospective Bidders are expected to carefully examine all documents, schedules, and requirements in this ITB, and respond to each requirement in the format prescribed. Bids may be found non-responsive if they do not conform to the ITB.

B. PROCURING OFFICE AND COMMUNICATION WITH STATE STAFF ANDEVALUATORS

Procurement responsibilities related to this ITB reside with the SPB. The point of contact (POC) for the procurement is as follows:

Name: Kristen Kosch and René A. Botts
 Agency: State Purchasing Bureau
 Address: 1526 K Street, Suite 130
 Lincoln, NE 68508
 Telephone: 402-471-8889
 E-Mail: as.materielpurchasing@nebraska.gov

C. COMMUNICATION WITH STATE STAFF

From the date the ITB is issued until the Intent to Award is issued communication from the Bidder is limited to communication with the State Purchasing Bureau (SPB). Only SPB is empowered to make binding statements regarding this ITB. SPB will issue any clarifications or opinions regarding this ITB in writing. Only SPB can modify the ITB, answer questions, render opinions, and only the SPB can award a contract. Bidders shall not have any communication with, or attempt to communicate or influence any evaluator involved in this ITB. After the intent to award is issued the Bidder may communicate with individuals the State has designated as responsible for negotiating the contract on behalf of the State.

The following exceptions to these restrictions are permitted:

1. Contact made pursuant to pre-existing contracts or obligations;
2. Contact required by the schedule of events or an event scheduled later by the SPB; and
3. Contact required for negotiation and execution of the final contract.

Violation of these conditions may be cause to reject a Bidder's bid and/or withdraw an award.

D. SCHEDULE OF EVENTS

The State expects to adhere to the procurement schedule shown below, but all dates are approximate and subject to change.

ACTIVITY		DATE/TIME
1.	Release ITB	June 28, 2017
2.	Last day to submit written questions	July 12, 2017
3.	State responds to written questions through ITB "Addendum" and/or "Amendment" to be posted to the Internet at: http://das.nebraska.gov/materiel/purchasing.html	July 14, 2017
4.	Bid opening Location: State Purchasing Bureau 1526 K Street, Suite 130 Lincoln, NE 68508	August 1, 2017 2:00 PM Central Time
5.	Review for conformance of mandatory requirements	TBA
6.	Review period	TBA
7.	Post "Letter of Intent to Contract" to Internet at: http://das.nebraska.gov/materiel/purchasing.html	TBA
8.	Contract finalization period	TBA
9.	Contract award	TBA
10.	Contractor start date	TBA

E. RECYCLING (§ 81-15,159(d)(2))

Preference will be given to items which are manufactured or produced from recycled material or which can be readily reused or recycled after their normal use. Preference will also be given to purchases of corn-based biodegradable plastics and road deicers if available and suitable. No preference shall be given if such preference would result in the purchase of products, materials, or supplies that are of inadequate quality or of substantially higher cost.

F. SECRETARY OF STATE/TAX COMMISSIONER REGISTRATION REQUIREMENTS (Statutory)

All Bidders must be authorized to transact business in the State and comply with all Nebraska Secretary of State Registration requirements. The Bidder who is the recipient of an Intent to Award will be required to certify that it has complied and produce a true and correct copy of its current (within ninety (90) calendar days of the intent to award) Certificate or Letter of Good Standing, or in the case of a sole proprietorship, provide written documentation of sole proprietorship and the United States Citizenship Attestation Form, available on the DAS website at <http://das.nebraska.gov/materiel/purchasing.html>. This must be accomplished prior to execution of the contract.

G. ETHICS IN PUBLIC CONTRACTING

The State reserves the right to reject bids, withdraw an intent to award or award, or terminate a contract if a Bidder commits or has committed ethical violations, which include, but are not limited to:

1. Offering or giving, directly or indirectly, a bribe, fee, commission, compensation, gift, gratuity, or anything of value to any person or entity in an attempt to influence the bidding process;
2. Utilize the services of lobbyists, attorneys, political activists, or consultants to influence or subvert the bidding process;
3. Being considered for, presently being, or becoming debarred, suspended, ineligible, or excluded from contracting with any state or federal entity;
4. Submitting a bid on behalf of another party or entity;
5. Collude with any person or entity to influence the bidding process, submit sham bids, preclude bidding, fix pricing or costs, create an unfair advantage, subvert the bid, or prejudice the State,

The Bidder shall include this clause in any subcontract entered into for the exclusive purpose of performing this contract.

Bidder shall have an affirmative duty to report any violations of this clause by the Bidder throughout the bidding process, and throughout the term of this contract for the successful Bidder and their subcontractors.

H. SPECIFICATIONS

Any manufacturer's names, trade names, brand names, information and/or catalog numbers listed in a specification are for reference and not intended to limit competition, but will be used as the standard by which equivalent material offered will be judged. The Materiel Administrator will be the sole judge of equivalency. The Bidder may offer any brands which meets or exceeds the specification. When a specific product is required, the ITB will so state. Any item bid is to be the latest current model under standard production at the time of order. No used or refurbished equipment will be accepted, unless otherwise stated.

I. SAMPLES

When requested, samples shall be furnished at the Bidder's expense prior to the opening of the bid, unless otherwise specified. Each sample must be labeled clearly and identify the Bidder's name, the ITB number and the item number. Samples submitted must be representative of the commodities or equipment which would be delivered if awarded the bid. The State reserves the right to request samples even though this may not have been set forth in the ITB. Samples not destroyed in testing will be returned at Bidder's expense, if requested, or will be donated to a public institution.

J. BID PREPARATION COSTS

The State shall not incur any liability for any costs incurred by Bidders in replying to this ITB, including any activity related to bidding on this ITB.

K. DISCOUNTS

Prices quoted shall be inclusive of ALL trade discounts. Cash discount terms of less than thirty (30) days will not be considered as part of the bid. Cash discount periods will be computed from the date of receipt of a properly executed claim voucher or the date of completion of delivery of all items in a satisfactory condition, whichever is later.

L. PRICES

All prices, costs, and terms and conditions outlined in the bid shall remain fixed and valid commencing on the opening date of the bid until termination of the contract.

Prices quoted on the ITB form or Cost Sheet shall remain fixed for the first year of the contract period. Any request for a price increase subsequent to first year period must be submitted in writing to the SPB for approval, and be accompanied by documentation justifying the price increase. These documents include, but are not limited to: 1) invoices for physical components of contracted item(s) Further documentation may be required by the State to justify the increase. The State reserves the right to deny any requested price increase. No price increases are to be billed to any State Agencies prior to written amendment of the contract by the parties.

M. DEVIATIONS FROM THE INVITATION TO BID

The requirements contained in the ITB (Sections II and VI) become a part of the terms and conditions of the contract resulting from this ITB. Any deviations from the ITB in Section II and VI must be clearly defined by the Bidder in its bid and, if accepted by the State, will become part of the contract. Any specifically defined deviations must not be in conflict with the basic nature of the ITB, mandatory requirements, or applicable state or federal laws or statutes. "Deviation", for the purposes of this ITB, means any proposed changes or alterations to either the contractual language or deliverables within the scope of this ITB. The State discourages deviations and reserves the right to reject proposed deviations.

N. VALID BID TIME

Bids shall be firm for a minimum of ninety (90) calendar days after the opening date, unless otherwise stipulated by either party in the ITB.

O. LUMP SUM OR 'ALL OR NONE' BIDS

The State reserves the right to purchase item-by-item, by groups or as a total when the State may benefit by so doing. Bidders may submit a bid on an "all or none" or "lump sum" basis, but should also submit a bid on an item-by-item basis. The term "all or none" means a conditional bid which requires the purchase of all items on which bids are offered and Bidder declines to accept award on individual items; a "lump sum" bid is one in which the Bidder offers a lower price than the sum of the individual bids if all items are purchased, but agrees to deliver individual items at the prices quoted.

P. BID REQUIREMENTS

The bids will first be examined to determine if all requirements listed below have been addressed and whether further evaluation is warranted. Bids not meeting the requirements may be rejected as non-responsive. The requirements are:

1. Original Commodity ITB form signed using an indelible method (electronic signatures are not acceptable);
2. Clarity and responsiveness of the bid;
3. Completed Sections II and VI ;
4. Completed ITB Form or State's Bid Sheet.

Q. FAILURE TO COMPLY WITH INVITATION TO BID

Violation of the terms and conditions contained in this ITB or any resultant contract, at any time before or after the award, shall be grounds for action by the State which may include, but is not limited to, the following:

1. Rejection of a Bidder's bid;
2. Withdrawal of the Intent to Award;
3. Withdrawal of the Award;
4. Termination of the resulting contract;
5. Legal action; or,
6. Suspension of the Bidder from further bidding with the State for the period of time relative to the seriousness of the violation, such period to be within the sole discretion of the State.

R. SUBMISSION OF BIDS

ALL BIDS MUST BE SUBMITTED IN A SEALED ENVELOPE OR CONTAINER!

Only one (1) original bid shall be submitted. Each bid should be in a separate envelope or container. Bid responses should include the completed Form A, "Bidder Contact Sheet". Bids must reference the ITB number and be sent to the specified address. Please note that the address label should appear as specified in Section II, Part A on the face of each container or Bidder's bid response packet. If a recipient phone number is required for delivery purposes, 402-471-6500 should be used. The ITB number must be included in all correspondence.

Emphasis should be concentrated on conformance to the ITB instructions, responsiveness to requirements, completeness, and clarity of content. If the Bidder's bid is presented in such a fashion that makes evaluation difficult or overly time consuming the State reserves the right to reject the bid as non-conforming.

By signing the "ITB" form, the Bidder guarantees compliance with the provisions stated in this ITB.

S. EMAIL SUBMISSIONS

The SPB will not accept bids by email except for one-time purchases under \$25,000.00. .

T. BID CORRECTIONS

A bidder may correct a mistake in a bid prior to the time of opening by giving written notice to the State of intent to withdraw the bid for modification or to withdraw the bid completely. Changes in a bid after opening are acceptable only if the change is made to correct a minor error that does not affect price, quantity, quality, delivery, or contractual conditions. In case of a mathematical error in extension of price, unit price shall govern.

U. LATE BIDS

Bids received after the time and date of the bid opening will be considered late bids. Late bids will be returned unopened, if requested by the Bidder and at Bidder's expense. The State is not responsible for bids that are late or lost regardless of cause or fault.

V. BID OPENING

Anyone may attend the opening. It is considered a public opening. The Buyer will read the names of the respondents. Depending upon the complexity of the bid, the buyer may read the bids aloud or allow bids be available for viewing by the public during the bid opening. Once the bid opening has concluded, the bids will not be available for viewing until the Intent to Award has been posted. An initial bid tabulation will be posted to the website as soon as feasible. Information identified as proprietary by the submitting vendor, in accordance with the RFP/ITB and state statute, will not be posted. If the state determines submitted information should not be withheld, in accordance with the [Public Records Act](#), or if ordered to release any withheld information, said information may then be released. The submitting bidder will be notified of the release and it shall be the obligation of the submitting bidder to take further action, if it believes the information should not be released.

W. BID TABULATIONS

Bid tabulations are available on the website at: <http://www.das.state.ne.us/materiel/purchasing/bidtabs.htm>.

X. BEST AND FINAL OFFER

The State reserves the right to request Best and Final Offers. However, a Bidder should provide its best offer in its original bid. Bidders should not expect that the State will request a best and final offer.

Y. REFERENCE AND CREDIT CHECKS

The State reserves the right to conduct and consider reference and credit checks. Reference or credit checks may be grounds to reject a bid, or withdraw an intent to award or award of a contract. The State reserves the right to use third parties to conduct reference and credit checks.

Z. REJECTION OF BIDS

The State reserves the right to reject any or all bids, wholly or in part, in the best interest of the State.

AA. RESIDENT BIDDER

Pursuant to Neb. Rev. Stat. §§ 73-101.01 through 73-101.02, a Resident Bidder shall be allowed a preference against a Non-resident Bidder from a state which gives or requires a preference to Bidders from that state. The preference shall be equal to the preference given or required by the state of the Nonresident Bidders. Where the lowest responsible bid from a resident Bidder is equal in all respects to one from a nonresident Bidder from a state which has no preference law, the resident Bidder shall be awarded the contract. The provision of this preference shall not apply to any contract for any project upon which federal funds would be withheld because of the provisions of this preference.

BB. AWARD

All purchases, leases, or contracts which are based on competitive bids will be awarded according to the provisions in the ITB. The State reserves the right to reject any or all bids, in whole or in part, or to award to multiple Bidders in whole or in part, and at its discretion, may withdraw or amend the ITB at any time. The State reserves the right to waive any deviations or errors that are not material, do not invalidate the legitimacy of the bid, and do not improve the Bidder's competitive position. All awards will be made in a manner deemed in the best interest of the State. The ITB does not commit the State to award a contract. If, in the opinion of the State, revisions or amendments will require substantive changes in bids, the bid opening date may be extended.

By submitting a bid in response to this ITB, the Bidder grants to the State the right to contact or arrange a visit in person with any or all of the Bidder's clients.

Once the Intent to Award decision has been made, an Intent to Award will be posted to the Internet at: <http://das.nebraska.gov/materiel/purchasing.html>

The protest procedure is available on the Internet at:

[http://das.nebraska.gov/materiel/purchase_bureau/docs/vendors/protest/ProtestGrievanceProcedureForVendors%20\(2\).pdf](http://das.nebraska.gov/materiel/purchase_bureau/docs/vendors/protest/ProtestGrievanceProcedureForVendors%20(2).pdf)

Any protests must be filed by a vendor within ten (10) business days after the Intent to Award is posted to the Internet.

The State reserves the right to award contracts in a manner, and utilizing methods, selected in the State's best interest and discretion. The State may waive informalities or irregularities in bids if the waiver is in the best interest of the State and such waiver does not prejudice other Bidders in the State's discretion. After evaluation of the bids, the State may take, in the State's discretion, one or more of the following actions:

- Accept or reject a portion of or all of a bid;
- Accept or reject all bids;
- Withdraw the ITB;
- Elect to rebid the ITB;
- Award single lines or multiple lines to one or more Bidders; or,
- Award one or more complete contracts.

The State reserves the right to make awards that are in the best interest of the State. The State may consider, but is not limited to, one (1) or more of the following award criteria:

- Price;
- Location;
- Quality;
- Delivery time; and,
- State contract management requirements and/or costs.

II. TERMS AND CONDITIONS

Bidders should complete Section II through VI as part of their bid. Bidder is expected to read the Terms and Conditions and must initial either accept, reject, or reject and provide alternative language for each clause. The Bidder should also provide an explanation of why the Bidder rejected the clause or rejected the clause and provided alternate language using 'Track Changes'. Upon request an electronic copy of the bid with 'Track Changes' must be submitted in an editable Word format. By signing the ITB Bidder is agreeing to be legally bound by all the accepted terms and conditions, and any proposed alternative terms and conditions submitted with the bid. The State reserves the right to negotiate rejected or proposed alternative language. If the State and Bidder fail to agree on the final Terms and Conditions, the State reserves the right to reject the bid. The State is soliciting bids in response to the ITB. The State reserves the right to reject bids that attempt to substitute the Bidder's commercial contracts and/or documents for this ITB.

The Bidder should submit with their bid any license, user agreement, service level agreement, or similar documents that the Bidder wants incorporated in the Contract. Upon notice of Intent to Award, the Bidder must submit a copy of these documents in an editable Word format. The State will not consider incorporation of any document not submitted with the Bidder's bid. These documents shall be subject to negotiation and will be incorporated as addendums if agreed to by the Parties.

If a conflict or ambiguity arises after the addendums have been negotiated and agreed to, the addendums shall be interpreted as follows:

1. If only one (1) Party's document has a particular clause then that clause shall control;
2. If both Party's documents have a similar clause, but the clauses do not conflict, the clauses shall be read together;
3. If both Party's documents have a similar clause, but the clauses conflict, the State's clause shall control.

A. GENERAL

Accept (Initial)	Reject (Initial)	Reject & Provide Alternative within ITB Response (Initial)	NOTES/COMMENTS:
TS 			

The contract resulting from this ITB shall incorporate the following documents:

1. Invitation to Bid and Addenda;
2. Amendments to the ITB;
3. Questions and Answers;
4. Contractor's bid (ITB);
5. Award;
6. The executed Contract and any Addenda; and,
7. Amendments to the Contract

These documents constitute the entirety of the contract.

Unless otherwise specifically stated in a future contract amendment, in case of any conflict between the incorporated documents, the documents shall govern in the following order of preference with number one (1) receiving preference over all other documents and with each lower numbered document having preference over any higher numbered document: 1) Amendment to the executed Contract with the most recent dated amendment having the highest priority, 2) executed Contract and any attached Addenda, 3) Amendments to ITB and any Questions and Answers, 4) the original ITB document and any Addenda, and 5) the Contractor's submitted Bid.

Any ambiguity or conflict in the contract discovered after its execution, not otherwise addressed herein, shall be resolved in accordance with the rules of contract interpretation as established in the State.

B. NOTIFICATION

Accept (Initial)	Reject (Initial)	Reject & Provide Alternative within ITB Response (Initial)	NOTES/COMMENTS:
TS 			

--	--	--	--

Communications regarding the executed contract shall be in writing and shall be deemed to have been given if delivered personally or mailed, by U.S. Mail, postage prepaid, return receipt requested, to the parties at their respective addresses set forth below, or at such other addresses as may be specified in writing by either of the parties. All notices, requests, or communications shall be deemed effective upon personal delivery or three (3) calendar days following deposit in the mail.

Either party may change its address for notification purposes by giving notice of the change, and setting forth the new address and an effective date.

C. GOVERNING LAW

Notwithstanding any other provision of this contract, or any amendment or addendum(s) entered into contemporaneously or at a later time, the parties understand and agree that, (1) the State of Nebraska is a sovereign state and its authority to contract is therefore subject to limitation by the State's Constitution, statutes, common law, and regulation; (2) this contract will be interpreted and enforced under the laws of the State of Nebraska; (3) any action to enforce the provisions of this agreement must be brought in the State of Nebraska per state law; (4) the person signing this contract on behalf of the State of Nebraska does not have the authority to waive the State's sovereign immunity, statutes, common law, or regulations; (5) the indemnity, limitation of liability, remedy, and other similar provisions of the final contract, if any, are entered into subject to the State's Constitution, statutes, common law, regulations, and sovereign immunity; and, (6) all terms and conditions of the final contract, including but not limited to the clauses concerning third-party use, licenses, warranties, limitations of liability, governing law and venue, usage verification, indemnity, liability, remedy or other similar provisions of the final contract are entered into specifically subject to the State's Constitution, statutes, common law, regulations, and sovereign immunity.

The Parties must comply with all applicable local, state and federal laws, ordinances, rules, orders, and regulations.

D. BEGINNING OF WORK

E. The Contractor shall not commence any billable work until a valid contract has been fully executed by the State and the successful Contractor. CHANGE ORDERS OR SUBSTITUTIONS

Accept (Initial)	Reject (Initial)	Reject & Provide Alternative within ITB Response (Initial)	NOTES/COMMENTS:
TS (15)			

The State and the Contractor, upon the written agreement, may make changes to the contract within the general scope of the ITB. Changes may involve specifications, the quantity of work, or such other items as the State may find necessary or desirable. Corrections of any deliverable, service, or work required pursuant to the contract shall not be deemed a change. The Contractor may not claim forfeiture of the contract by reasons of such changes.

The State or Contractor may prepare a written description of the work required due to the change and the Contractor shall prepare an itemized cost sheet for the change. Changes in work and the amount of compensation to be paid to the Contractor shall be determined in accordance with applicable unit prices if any, a pro-rated value, or through negotiations. The State shall not incur a price increase for changes that should have been included in the Contractor's bid, were foreseeable, or result from difficulties with or failure of the Contractor's bid or performance.

No change shall be implemented by the Contractor until approved by the State, and the Contract is amended to reflect the change and associated costs, if any. If there is a dispute regarding the cost, but both parties agree that immediate implementation is necessary, the change may be implemented, and cost negotiations may continue with both Parties retaining all remedies under the contract and law.

Vendor will not substitute any item that has been awarded without prior written approval of SPB.

F. BREACH

Accept (Initial)	Reject (Initial)	Reject & Provide Alternative within ITB Response (Initial)	NOTES/COMMENTS:
TS 			

Either Party may terminate the contract, in whole or in part, if the other Party breaches its duty to perform its obligations under the contract in a timely and proper manner. Termination requires written notice of default and a thirty (30) calendar day (or longer at the non-breaching Party's discretion considering the gravity and nature of the default) cure period. Said notice shall be delivered by Certified Mail, Return Receipt Requested, or in person with proof of delivery. Allowing time to cure a failure or breach of contract does not waive the right to immediately terminate the contract for the same or different contract breach which may occur at a different time.

In case of breach by the Contractor, the State may, without unreasonable delay, make a good faith effort to make a reasonable purchase or contract to purchased goods in substitution of those due from the contractor. The State may recover from the Contractor as damages the difference between the costs of covering the breach. Notwithstanding any clause to the contrary, the State may also recover the contract price together with any incidental or consequential damages defined in UCC Section 2-715, but less expenses saved in consequence of Contractor's breach.

The State's failure to make payment shall not be a breach, and the Contractor shall retain all available statutory remedies. (See Indemnity - Self-Insurance and Payment)

G. NON-WAIVER OF BREACH

Accept (Initial)	Reject (Initial)	Reject & Provide Alternative within ITB Response (Initial)	NOTES/COMMENTS:
TS 			

The acceptance of late performance with or without objection or reservation by a Party shall not waive any rights of the Party nor constitute a waiver of the requirement of timely performance of any obligations remaining to be performed.

H. SEVERABILITY

Accept (Initial)	Reject (Initial)	Reject & Provide Alternative within ITB Response (Initial)	NOTES/COMMENTS:
TS 			

If any term or condition of the contract is declared by a court of competent jurisdiction to be illegal or in conflict with any law, the validity of the remaining terms and conditions shall not be affected, and the rights and obligations of the parties shall be construed and enforced as if the contract did not contain the provision held to be invalid or illegal.

I. INDEMNIFICATION

Accept (Initial)	Reject (Initial)	Reject & Provide Alternative within ITB Response (Initial)	NOTES/COMMENTS:
TS 			

1. GENERAL

The Contractor agrees to defend, indemnify, and hold harmless the State and its employees, volunteers, agents, and its elected and appointed officials (“the indemnified parties”) from and against any and all claims, liens, demands, damages, liability, actions, causes of action, losses, judgments, costs, and expenses of every nature, including investigation costs and expenses, settlement costs, and attorney fees and expenses (“the claims”), sustained or asserted against the State for personal injury, death, or property loss or damage, arising out of, resulting from, or attributable to the willful misconduct, negligence, error, or omission of the Contractor, its employees, Subcontractors, consultants, representatives, and agents, resulting from this contract, except to the extent such Contractor liability is attenuated by any action of the State which directly and proximately contributed to the claims.

2. SELF-INSURANCE (Statutory)

The State is self-insured for any loss and purchases excess insurance coverage pursuant to Neb. Rev. Stat. § 81-8,239.01 (Reissue 2008). If there is a presumed loss under the provisions of this agreement, Contractor may file a claim with the Office of Risk Management pursuant to Neb. Rev. Stat. §81-8,829 through 81-8,306 for review by the State Claims Board. The State retains all rights and immunities under the State Miscellaneous (Section 81-8,294), Tort (Section 81-8,209), and Contract Claim Acts (Section 81-8,302), as outlined in Neb. Rev. Stat. § 81-8,209 et seq. and under any other provisions of law and accepts liability under this agreement to the extent provided by law.

J. ATTORNEY’S FEES

Accept (Initial)	Reject (Initial)	Reject & Provide Alternative within ITB Response (Initial)	NOTES/COMMENTS:
TS 			

In the event of any litigation, appeal, or other legal action to enforce any provision of the contract, the Parties agree to pay all expenses of such action, as permitted by law and if order by the court, including attorney’s fees and costs, if the other party prevails.

K. ASSIGNMENT, SALE, OR MERGER

Accept (Initial)	Reject (Initial)	Reject & Provide Alternative within ITB Response (Initial)	NOTES/COMMENTS:
TS 			

Either party may assign the contract upon mutual written agreement of the other party. Such agreement shall not be unreasonably withheld.

The Contractor retains the right to enter into a sale, merger, acquisition, internal reorganization, or similar transaction involving Contractor’s business. Contractor agrees to cooperate with the State in executing amendments to the contract to allow for the transaction. If a third party or entity is involved in the transaction, the Contractor will remain responsible for performance of the contract until such time as the person or entity involved in the transaction agrees in writing to be contractually bound by this contract and perform all obligations of the contract.

L. CONTRACTING WITH OTHER POLITICAL SUB-DIVISIONS OF THE STATE OR ANOTHER STATE

Accept (Initial)	Reject (Initial)	Reject & Provide Alternative within ITB Response (Initial)	NOTES/COMMENTS:
TS 			

The Contractor may, but shall not be required to, allow agencies, as defined in Neb. Rev. Stat. §81-145, to use this contract. The terms and conditions, including price, of the contract may not be amended. The State shall not be contractually obligated or liable for any contract entered into pursuant to this clause.

The Contractor may, but shall not be required to, allow other states, agencies or divisions of other states, or political subdivisions of other states to use this contract. The terms and conditions, including price, of this contract shall apply to any such contract, but may be amended upon mutual consent of the Parties. The State of Nebraska shall not be contractually or otherwise obligated or liable under any contract entered into pursuant to this clause. The State shall be notified if a contract is executed based upon this contract.

M. FORCE MAJEURE

Accept (Initial)	Reject (Initial)	Reject & Provide Alternative within ITB Response (Initial)	NOTES/COMMENTS:
TS 			

Neither party shall be liable for any costs or damages, or for default resulting from its inability to perform any of its obligations under the contract due to a natural or manmade event outside the control and not the fault of the affected party ("Force Majeure Event"). The Party so affected shall immediately make a written request for relief to the other party, and shall have the burden of proof to justify the request. The other Party may granted the relief requested; relief may not be unreasonably withheld. Labor disputes with the impacted party's own employees will not be considered a Force Majeure Event.

N. CONFIDENTIALITY

Accept (Initial)	Reject (Initial)	Reject & Provide Alternative within ITB Response (Initial)	NOTES/COMMENTS:
TS 			

All materials and information provided by the Parties or acquired by a Party on behalf of the other Party shall be regarded as confidential information. All materials and information provided or acquired shall be handled in accordance with federal and state law, and ethical standards. Should said confidentiality be breached by a Party, the Party shall notify the other Party immediately of said breach and take immediate corrective action.

It is incumbent upon the Parties to inform their officers and employees of the penalties for improper disclosure imposed by the Privacy Act of 1974, 5 U.S.C. 552a. Specifically, 5 U.S.C. 552a (i)(1), which is made applicable by 5 U.S.C. 552a (m)(1), provides that any officer or employee, who by virtue of his/her employment or official position has possession of or access to agency records which contain individually identifiable information, the disclosure of which is prohibited by the Privacy Act or regulations established thereunder, and who knowing that disclosure of the specific material is prohibited, willfully discloses the material in any manner to any person or agency not entitled to receive it, shall be guilty of a misdemeanor and fined not more than \$5,000.

O. EARLY TERMINATION

Accept (Initial)	Reject (Initial)	Reject & Provide Alternative within ITB Response (Initial)	NOTES/COMMENTS:
TS 			

The contract may be terminated as follows:

1. The State and the Contractor, by mutual written agreement, may terminate the contract at any time.
2. The State, at its sole discretion, may terminate the contract for any reason upon thirty (30) calendar day's written notice to the Contractor. Such termination shall not relieve the Contractor of warranty or other service obligations incurred under the terms of the contract. In the event of termination the Contractor shall be entitled to payment, determined on a pro rata basis, for products or services satisfactorily performed or provided.
3. The State may terminate the contract immediately for the following reasons:
 - a. if directed to do so by statute;
 - b. Contractor has made an assignment for the benefit of creditors, has admitted in writing its inability to pay debts as they mature, or has ceased operating in the normal course of business;
 - c. a trustee or receiver of the Contractor or of any substantial part of the Contractor's assets has been appointed by a court;
 - d. fraud, misappropriation, embezzlement, malfeasance, misfeasance, or illegal conduct pertaining to performance under the contract by its Contractor, its employees, officers, directors, or shareholders;
 - e. an involuntary proceeding has been commenced by any party against the Contractor under any one of the chapters of Title 11 of the United States Code and (i) the proceeding has been pending for at least sixty (60) calendar days; or (ii) the Contractor has consented, either expressly or by operation of law, to the entry of an order for relief; or (iii) the Contractor has been decreed or adjudged a debtor;
 - f. a voluntary petition has been filed by the Contractor under any of the chapters of Title 11 of the United States Code;
 - g. Contractor intentionally discloses confidential information;
 - h. Contractor has or announces it will discontinue support of the deliverable; and,
 - i. In the event funding is no longer available.

P. CONTRACT CLOSEOUT

Accept (Initial)	Reject (Initial)	Reject & Provide Alternative within ITB Response (Initial)	NOTES/COMMENTS:
TS 			

Upon termination of the contract for any reason the Contractor shall within thirty (30) days, unless stated otherwise herein:

1. Transfer all completed or partially completed deliverables to the State;
2. Transfer ownership and title to all completed or partially completed deliverables to the State;
3. Return to the State all information and data, unless the Contractor is permitted to keep the information or data by contract or rule of law. Contractor may retain one copy of any information or data as required to comply with applicable work product documentation standards or as are automatically retained in the course of Contractor's routine back up procedures;
4. Cooperate with any successor contractor, person or entity in the assumption of any or all of the obligations of this contract;
5. Cooperate with any successor contractor, person or entity with the transfer of information or data related to this contract;
6. Return or vacate any state owned real or personal property;

Nothing in this Section should be construed to require the Contractor to surrender intellectual property, real or personal property, or information or data owned by the Contractor for which the State has no legal claim.

III. CONTRACTOR DUTIES

A. INDEPENDENT CONTRACTOR / OBLIGATIONS

Accept (Initial)	Reject (Initial)	Reject & Provide Alternative within ITB Response (Initial)	NOTES/COMMENTS:
TS 			

It is agreed that the Contractor is an independent contractor and that nothing contained herein is intended or should be construed as creating or establishing a relationship of employment, agency, or a partnership.

The Contractor is solely responsible for fulfilling the contract. The Contractor or the Contractor's representative shall be the sole point of contact regarding all contractual matters.

The Contractor shall secure, at its own expense, all personnel required to perform the services under the contract. The personnel the Contractor uses to fulfill the contract shall have no contractual or other legal relationship with the State; they shall not be considered employees of the State and shall not be entitled to any compensation, rights or benefits from the State, including but not limited to, tenure rights, medical and hospital care, sick and vacation leave, severance pay, or retirement benefits.

By-name personnel commitments made in the Contractor's bid shall not be changed without the prior written approval of the State. Replacement of these personnel, if approved by the State, shall be with personnel of equal or greater ability and qualifications.

The Contractor warrants that all persons assigned to the project shall be employees of the Contractor or a Subcontractor, and shall be fully qualified to perform the work required herein. Personnel employed by the Contractor or a subcontractor to fulfill the terms of the contract shall remain under the sole direction and control of the Contractor or the subcontractor respectively.

With respect to its employees, the Contractor agrees to be solely responsible for the following:

1. Any and all pay, benefits, and employment taxes and/or other payroll withholding;
2. Any and all vehicles used by the Contractor's employees, including all insurance required by state law;
3. Damages incurred by Contractor's employees within the scope of their duties under the contract;
4. Maintaining Workers' Compensation and health insurance that complies with state and federal law and submitting any reports on such insurance to the extent required by governing law;
5. Determining the hours to be worked and the duties to be performed by the Contractor's employees; and,
6. All claims on behalf of any person arising out of employment or alleged employment (including without limit claims of discrimination alleged against the Contractor, its officers, agents, or subcontractors or subcontractor's employees).

If the Contractor intends to utilize any subcontractor, the Subcontractor's level of effort, tasks, and time allocation must be clearly defined in the Contractor's bid. The Contractor shall agree that it will not utilize any Subcontractors not specifically included in its bid in the performance of the contract without the prior written authorization of the State.

The State reserves the right to require the Contractor to reassign or remove from the project any Contractor or Subcontractor employee.

Contractor shall insure that the terms and conditions contained in any contract with a sub-contractor does not conflict with the terms and conditions of this contract.

The Contractor shall include a similar provision, for the protection of the State, in the contract with any Subcontractor engaged to perform work on this contract.

B. EMPLOYEE WORK ELIGIBILITY STATUS

The Contractor is required and hereby agrees to use a federal immigration verification system to determine the work eligibility status of employees physically performing work within the State. A federal immigration verification system means the electronic verification of the work authorization program authorized by the Illegal Immigration Reform and

Immigrant Responsibility Act of 1996, 8 U.S.C. 1324a, known as the E-Verify Program, or an equivalent federal program designated by the United States Department of Homeland Security or other federal agency authorized to verify the work eligibility status of an employee.

If the Contractor is an individual or sole proprietorship, the following applies:

1. The Contractor must complete the United States Citizenship Attestation Form, available on the DAS website at <http://das.nebraska.gov/materiel/purchasing.html>

The completed United States Attestation Form should be submitted with the ITB response.

2. If the Contractor indicates on such attestation form that he or she is a qualified alien, the Contractor agrees to provide the U.S. Citizenship and Immigration Services documentation required to verify the Contractor's lawful presence in the United States using the Systematic Alien Verification for Entitlements (SAVE) Program.
3. The Contractor understands and agrees that lawful presence in the United States is required and the Contractor may be disqualified or the contract terminated if such lawful presence cannot be verified as required by Neb. Rev. Stat. § 4-108.

C. COMPLIANCE WITH CIVIL RIGHTS LAWS AND EQUAL OPPORTUNITY EMPLOYMENT / NONDISCRIMINATION (Statutory)

The Contractor shall comply with all applicable local, state, and federal statutes and regulations regarding civil rights laws and equal opportunity employment. The Nebraska Fair Employment Practice Act prohibits Contractors of the State, and their Subcontractors, from discriminating against any employee or applicant for employment, with respect to hire, tenure, terms, conditions, compensation, or privileges of employment because of race, color, religion, sex, disability, marital status, or national origin (Neb. Rev. Stat. §48-1101 through 48-1125). The Contractor guarantees compliance with the Nebraska Fair Employment Practice Act, and breach of this provision shall be regarded as a material breach of contract. The Contractor shall insert a similar provision in all Subcontracts for goods or services to be covered by any contract resulting from this ITB.

D. COOPERATION WITH OTHER CONTRACTORS

Accept (Initial)	Reject (Initial)	Reject & Provide Alternative within ITB Response (Initial)	NOTES/COMMENTS:
TS 			

Contractor may be required to work with or in close proximity to other contractors or individuals that may be working on the same or different projects. The Contractor shall agree to cooperate with such other contractors or individuals, and shall not commit or permit any act which may interfere with the performance of work by any other contractor or individual. Contractor is not required to compromise Contractor's intellectual property or proprietary information unless expressly required to do so by this contract.

E. PERMITS, REGULATIONS, LAWS

Accept (Initial)	Reject (Initial)	Reject & Provide Alternative within ITB Response (Initial)	NOTES/COMMENTS:
TS 			

The contract price shall include the cost of all royalties, licenses, permits, and approvals, whether arising from patents, trademarks, copyrights or otherwise, that are in any way involved in the contract. The Contractor shall obtain and pay for all royalties, licenses, and permits, and approvals necessary for the performance of the contract. The Contractor must guarantee that it has the full legal right to the materials, supplies, equipment, software, and other items used to execute this contract.

1. DEVIATIONS

The insurance requirements are subject to limited negotiation. Negotiation typically includes, but is not necessarily limited to, the correct type of coverage, necessity for Workers' Compensation, and the type of automobile coverage carried by the Contractor.

F. NOTICE OF POTENTIAL CONTRACTOR BREACH

Accept (Initial)	Reject (Initial)	Reject & Provide Alternative within ITB Response (Initial)	NOTES/COMMENTS:
TS 			

If Contractor breaches the contract or anticipates breaching the contract the Contractor shall immediately give written notice to the State. The notice shall explain the breach or potential breach, and may include a request for a waiver of the breach if so desired. The State may, at its discretion, temporarily or permanently waive the breach. By granting a temporary waiver, the State does not forfeit any rights or remedies to which the State is entitled by law or equity, or pursuant to the provisions of the contract. Failure to give immediate notice, however, may be grounds for denial of any request for a waiver of a breach.

G. ANTITRUST

Accept (Initial)	Reject (Initial)	Reject & Provide Alternative within ITB Response (Initial)	NOTES/COMMENTS:
TS 			

The Contractor hereby assigns to the State any and all claims for overcharges as to goods and/or services provided in connection with this contract resulting from antitrust violations which arise under antitrust laws of the United States and the antitrust laws of the State.

H. CONFLICT OF INTEREST

Accept (Initial)	Reject (Initial)	Reject & Provide Alternative within ITB Response (Initial)	NOTES/COMMENTS:
TS 			

By submitting a bid, Contractor certifies that there does not now exist a relationship between the Contractor and any person or entity which is or gives the appearance of a conflict of interest related to this ITB or project.

The Contractor certifies that it shall not take any action or acquire any interest, either directly or indirectly, which will conflict in any manner or degree with the delivery of its goods hereunder or which creates an actual or an appearance of conflict of interest.

The Contractor certifies that it will not employ any individual known by Contractor to have a conflict of interest.

The Parties shall not knowingly, for a period of two years after execution of the contract, recruit or employ any employee or agent of the other Party who has worked on the ITB or project, or who had any influence on decisions affecting the ITB or project.

I. ADVERTISING

Accept (Initial)	Reject (Initial)	Reject & Provide Alternative within ITB Response (Initial)	NOTES/COMMENTS:
TS 			

The Contractor agrees not to refer to the contract award in advertising in such a manner as to state or imply that the company or its goods are endorsed or preferred by the State. Any publicity releases pertaining to the project shall not be issued without prior written approval from the State.

J. DRUG POLICY

Accept (Initial)	Reject (Initial)	Reject & Provide Alternative within ITB Response (Initial)	NOTES/COMMENTS:
TS 			

Contractor certifies it maintains a drug free work place environment to ensure worker safety and workplace integrity. Contractor agrees to provide a copy of its drug free workplace policy at any time upon request by the State.

IV. PAYMENT

A. PROHIBITION AGAINST ADVANCE PAYMENT

Accept (Initial)	Reject (Initial)	Reject & Provide Alternative within ITB Response (Initial)	NOTES/COMMENTS:
TS 			

Payments shall not be made until contractual deliverable(s) are received and accepted by the State.

B. TAXES

Accept (Initial)	Reject (Initial)	Reject & Provide Alternative within ITB Response (Initial)	NOTES/COMMENTS:
TS 			

The State is not required to pay taxes and assumes no such liability as a result of this solicitation. The Contractor may request a copy of the Nebraska Department of Revenue, Nebraska Resale or Exempt Sale Certificate for Sales Tax Exemption, Form 13 for their records. Any property tax payable on the Contractor's equipment which may be installed in a state-owned facility is the responsibility of the Contractor.

C. INVOICES

Accept (Initial)	Reject (Initial)	Reject & Provide Alternative within ITB Response (Initial)	NOTES/COMMENTS:
TS 			

Invoices for payments must be submitted by the Contractor to the agency requesting the services with sufficient detail to support payment. Invoice is to be sent to the Nebraska Game and Parks Commission, Parks Division, 2200 N 33rd Street, Lincoln, NE 68503. The terms and conditions included in the Contractor's invoice shall be deemed to be solely for the convenience of the parties. No terms or conditions of any such invoice shall be binding upon the State, and no action by the State, including without limitation the payment of any such invoice in whole or in part, shall be construed as binding or estopping the State with respect to any such term or condition, unless the invoice term or condition has been previously agreed to by the State as an amendment to the contract.

D. INSPECTION AND APPROVAL

Accept (Initial)	Reject (Initial)	Reject & Provide Alternative within ITB Response (Initial)	NOTES/COMMENTS:
TS 			

Final inspection and approval of all work required under the contract shall be performed by the designated State officials.

If a simple inspection of the goods would reveal nonconformity, notice of nonconformity should be provided to the vendor as soon as reasonably practical, but not to exceed thirty (30) days from receipt of goods. This includes visual inspection of product to ensure packaging is not damaged, dented or compromised.

E. PAYMENT (Statutory)

State will render payment to Contractor when the terms and conditions of the contract and specifications have been satisfactorily completed on the part of the Contractor as solely determined by the State. (Neb. Rev. Stat. Section 73-506(1)). The State may require the Contractor to accept payment by electronic means such as ACH deposit. In no event shall the State be responsible or liable to pay for any services provided by the Contractor prior to the Effective Date of the contract, and the Contractor hereby waives any claim or cause of action for any such services.

F. LATE PAYMENT (Statutory)

The Contractor may charge the responsible agency interest for late payment in compliance with the State of Nebraska Prompt Payment Act (See Neb. Rev. Stat. §§ 81-2401 through 81-2408).

G. SUBJECT TO FUNDING / FUNDING OUT CLAUSE FOR LOSS OF APPROPRIATIONS (Statutory)

The State's obligation to pay amounts due on the Contract for a fiscal years following the current fiscal year is contingent upon legislative appropriation of funds. Should said funds not be appropriated, the State may terminate the contract with respect to those payments for the fiscal year(s) for which such funds are not appropriated. The State will give the Contractor written notice thirty (30) calendar days prior to the effective date of termination. All obligations of the State to make payments after the termination date will cease. The Contractor shall be entitled to receive just and equitable compensation for any authorized work which has been satisfactorily completed as of the termination date. In no event shall the Contractor be paid for a loss of anticipated profit.

H. RIGHT TO AUDIT (Statutory)

The State shall have the right to audit the Contractor's performance of this contract upon a thirty (30) day written notice. Contractor shall utilize generally accepted accounting principles, and shall maintain the accounting records, and other records and information relevant to the contract (Information) to enable the State to audit the contract. (Neb. Rev. Stat. §84-304 et seq.) The State may audit and the Contractor shall maintain the information during the term of the contract and for a period of five (5) years after the completion of this contract or until all issues or litigation are resolved, whichever is later. The Contractor shall make the Information available to the State at Contractor's place of business or a location acceptable to both Parties during normal business hours. If this is not practical or the Contractor so elects, the Contractor may provide electronic or paper copies of the Information. The State reserves the right to examine, make copies of, and take notes on any Information relevant to this contract, regardless of the form or the Information, how it is stored, or who possesses the Information. In no circumstances will contractor be required to create or maintain documents not kept in the ordinary course of contractor's business operations, nor will contractor be required to disclose any information, including but not limited to product cost data, which is confidential or proprietary to contractor.

The Parties shall pay their own costs of the audit unless the audit finds a previously undisclosed overpayment by the State. If a previously undisclosed overpayment exceeds three percent of the total contract billings, or if fraud, material misrepresentations, or non-performance is discovered on the part of the Contractor, the Contractor shall reimburse the State for the total costs of the audit. Overpayments and audit costs owed to the State shall be paid within ninety (90) days of written notice of the claim. The Contractor agrees to correct any material weaknesses or condition found as a result of the audit.

V. SCOPE OF WORK

The Bidder must provide the following information in response to this ITB.

A. SCOPE

It is the intent of this bid invitation to establish a contract to supply Can Buoys per the attached specifications from date of award for a period of one (1) year with the option to renew for an additional four (4) one (1) year periods when mutually agreeable to the vendor and the State. The State reserves the right to extend the period of this contract beyond the end date when mutually agreeable to the vendor and the State.

All items bid shall be of the latest manufacture in production as of the date of the ITB and be of proven performance and under standard design complete as regularly advertised and marketed. All necessary materials for satisfactory performance of the supplies shall be incorporated into the Can Buoys whether or not they may be specifically mentioned below.

Complete specifications, manufacturer's current descriptive literature and/or advertising data sheets with cuts or photographs must be included with the bid for the IDENTICAL items proposed. Any information necessary to show compliance with these specifications not given on the manufacturer's descriptive literature and/or advertising data sheets must be supplied in writing on or attached to the bid document. If manufacturer's information necessary to show compliance with these specifications is not attached to the bid document, the Bidder may be required to submit requested information within three (3) business days of a written request. Failure to submit requested descriptive literature or advertising data sheets may be grounds to reject the bid.

B. AMENDMENT

This Contract may be amended in writing, within scope, upon the agreement of both parties.

C. REVISIONS

In the event any product is discontinued or replaced upon mutual consent during the contract period, the State reserves the right to amend this contract to include the alternate product at the same price.

VI. INVITATION TO BID - TECHNICAL SPECIFICATIONS

A. BIDDER INSTRUCTIONS

Bidder must respond to each of the following statements. Specifications listed are minimum conditions that must be met in order for a Bidder to qualify for the award.

"YES" response means the Bidder guarantees they can meet this condition.

"NO" response means the Bidder cannot meet this condition and will not be considered.

"NO & PROVIDE ALTERNATIVE" responses should be used only with a narrative response in the NOTES/COMMENTS section explaining in detail any deviation from the Bidder's ability to meet the condition, and an explanation of how this would be determined to be an acceptable alternative to meeting the condition. Alternatives must be detailed in such a way that allows such deviations to be fully evaluated. The State shall determine at its sole discretion whether or not the Bidder's alternative is an acceptable alternative.

B. NON-COMPLIANCE STATEMENT

YES	NO	NO & PROVIDE ALTERNATIVE	
YES 13			1. Read these specifications carefully. Any and all exceptions to these specifications must be written on or attached to quotation request. Any noncompliance may void your quotation. Non-compliance to any single specification can void your quotation.
YES 13			2. It is the responsibility of Bidders to obtain information and clarifications as provided below. The State is not responsible for any erroneous or incomplete understandings or wrongful interpretations of this ITB by any Bidder.
YES 13			3. No interpretation related to the meaning of bid specifications or other pre-bid documents will be made orally to any Bidder by the State. Any ITB interpretation must be put in writing and faxed by the Bidder to: the State Purchasing Bureau, Fax (402) 471-2089 or e-mailed to AS Materiel Purchasing_ as.materielpurchasing@nebraska.gov by the last day to submit written questions that is specified in the Schedule of Events. (Inquiries received after the last day to submit written questions may not be addressed).
NOTES/COMMENTS:			

C. CAN BUOYS

YES	NO	NO & PROVIDE ALTERNATIVE	
		NO 13	1. 12" x 51" Can Buoys with external Ballast Rolyan Model B1251
		NO 13	2. ABS exterior, completely urethane foam filled and ultraviolet inhibited
YES 13			3. Self-righting without tackle
YES 13			4. Standard bands, symbols and messages to include: a. "BOATS KEEP OUT", b. "DANGER", c. "HAZARD AREA", d. "NO BOATS", e. "SLOW 5 MPH",

			f. "SWIM AREA".
YES (B)			5. Additional standard and non-stand messages.
YES (B)			6. Ballast attached by a galvanized steel pipe
YES (B)			7. 3" silver reflective band at top
		NO (B)	8. Concrete ballast encased in ABS
YES (B)			9. Bidder verifies buoys offered in this Invitation to Bid meet Coast Guard Standards.
NOTES/COMMENTS: 1. 14"x52" Can Buoys with External Ballast Sealite model B1452 2. Virgin polyethylene exterior, completely closed cell polyurethane foam filled and ultra violet inhibited 8. Concrete ballast partially encased in polyethylene (B)			

D. ACCEPTABLE BRANDS

YES	NO	NO & PROVIDE ALTERNATIVE	
		NO (B)	1. Products bid must be the brand AND model numbers as specified on each line of the Bid Document. The State will not be accepting alternatives to the brands specified Roylan Can Buoys Model#B1251.
		NO (B)	2. Equipment bid shall be the latest current models in production as of the date of the ITB and be of proven performance and under standard design, complete as regularly advertised and marketed and shall be delivered complete with all necessary parts, specified accessories, tools, and special features, whether or not they may be specifically mentioned below. Used, demonstrator, prototype, or discontinued equipment is not acceptable. Complete specifications, manufacturer's descriptive literature and/or advertising data sheets with cuts or photographs may be required prior to an award and should be included with the bid on the IDENTICAL equipment proposed. Literature should be complete and the latest published. Any information necessary to show compliance with these specifications not given on the manufacturer's descriptive literature and/or advertising data sheets should be supplied in writing on or attached to the bid document. Roylan Can Buoys Model #B1251 bid must meet or exceed the following requirements.
NOTES/COMMENTS: 1. Alternative brand submitted is: Sealite model # B1452 2. Sealite has attached literature for the Sealite brand model #B1452. Sealite confirms that its Model #B1452 meets and exceeds specifications of the Rolyan brand as noted on the attached Specification Compliance/Comparison Sheet (item 7) (B)			

E. ANNUAL USAGE, ESTIMATED

YES	NO	NO & PROVIDE ALTERNATIVE	
Yes <input checked="" type="checkbox"/>			1. Annual usage figures provided are estimates and are not to be construed as either a minimum or maximum purchase quantity. The orders shall be for the actual quantities of each item ordered by or for any agency during the life of the contract. Vendor shall not impose minimum order requirements.
Yes <input checked="" type="checkbox"/>			2. Annual estimated usage of 80 each.
NOTES/COMMENTS:			

F. USAGE REPORT

YES	NO	NO & PROVIDE ALTERNATIVE	
Yes <input checked="" type="checkbox"/>			1. The vendor shall, provide a quarterly usage report of this contract by state agencies and political subdivisions. Information will include agency name, item, and dollar amount. Information may be requested at any time by the SPB, as determined by the State.
NOTES/COMMENTS:			

G. DELIVERY ARO

YES	NO	NO & PROVIDE ALTERNATIVE	
		No <input checked="" type="checkbox"/>	1. Delivery shall be within 30 days after receipt of order(s), or notification to the agency of the delay.
Yes <input checked="" type="checkbox"/>			2. At the time of delivery, a designated State employee will sign the "invoice/packing slip." This signature will only indicate that the order has been received and that the items actually delivered agree with the delivery invoice. This signature does not indicate all items were received in good condition and/or that there is not possible hidden damage.
NOTES/COMMENTS: 1. Partial delivery (of 100 #B1452) shall be delivered within 30 days after receipt of order. Balance (of 100 #B1452) to be delivered within 60 days after receipt of order.			

H. DELIVER LOCATIONS/INSTRUCTIONS (BIDDER IS CERTIFYING THAT THEY CAN MEET THE DELIVER LOCATIONS/INSTRUCTIONS)

YES	NO	NO & PROVIDE ALTERNATIVE	
Yes 			1. Deliver to: NE Game & Parks Commission Pawnee State Recreation Area 3800 NW 105th St. Lincoln, NE 68524-8816
NOTES/COMMENTS:			

I. PACKAGING

YES	NO	NO & PROVIDE ALTERNATIVE	
Yes 			1. Cartons are to be clearly marked with size, weight, color, quantity, and the purchase order number. Cartons must be of suitable size and of sufficient strength to protect the contents during shipping, handling and storage. 2.
NOTES/COMMENTS:			

J. ORDERS

YES	NO	NO & PROVIDE ALTERNATIVE	
Yes 			1. Orders will be placed either by, phone, fax, e-mail or Internet (if available and not to the exclusion of the other methods). All orders must reference a purchase order number and the purchase order number must be referenced on the packing slip, and invoice. Invoices are to be sent to the "Invoice to" address on the purchase order.
NOTES/COMMENTS:			

K. QUALITY

YES	NO	NO & PROVIDE ALTERNATIVE	
Yes 			1. Product quality must meet specifications and be consistent for the term of the contract. A guarantee of satisfactory performance by the supplier and meeting delivery dates are considered to be an integral part of the purchase contract resulting from this bid invitation. All materials must be of first quality, under standard production by the manufacturer and be of standard design, complete as regularly advertised and marketed and be of proven performance. Products are to be fully guaranteed and may be returned for full credit or replacement (at the State's option) for any reason during the initial warranty period with no additional charges for shipping or restocking.

Form A
Bidder Contact Sheet
Invitation To Bid Number 5628 OF

Form A should be completed and submitted with each response to this ITB. This is intended to provide the State with information on the Bidder's name and address, and the specific person(s) who are responsible for preparation of the Bidder's response.

Preparation of ITB Contact Information	
Bidder Name:	Sealite USA, LLC
Bidder Address:	61 Business Park Drive Tilton, New Hampshire 03276
Contact Person & Title:	Hilary Charest
E-mail Address:	h.charest@sealite.com
Telephone Number (Office):	(603)737-1327
Telephone Number (Cellular):	(603)520-4441
Fax Number:	(603)737-1320

Each Bidder shall also designate a specific contact person who will be responsible for responding to the State if any clarifications of the Bidder's response should become necessary.

Communication with the State Contact Information	
Bidder Name:	Sealite USA, LLC
Bidder Address:	61 Business Park Drive Tilton, New Hampshire 03276
Contact Person & Title:	Hilary Charest
E-mail Address:	h.charest@sealite.com
Telephone Number (Office):	(603)737-1327
Telephone Number (Cellular):	(603)520-4441
Fax Number:	(603)737-1320

ADDENDUM ONE REVISED, QUESTIONS and ANSWERS

Date: July 14, 2017
To: All Bidders
From: Kristen Kosch, Buyer
AS Materiel State Purchasing Bureau
RE: Addendum for Invitation to Bid Number 5628 OF
to be opened August 01, 2017 at 2:00 p.m. Central Time

Questions and Answers

Following are the questions submitted and answers provided for the above mentioned Invitation to Bid. The questions and answers are to be considered as part of the Invitation to Bid. It is the Bidder's responsibility to check the State Purchasing Bureau website for all addenda or amendments.

<u>Question Number</u>	<u>Question</u>	<u>State Response</u>
1.	Will you accept bids from companies who manufacture identical and/or similar buoy products to those specified as long as they meet the identified specifications in ITB?	The State of Nebraska has restricted this bid to the brand and models stated, based on using agency requirements. Bidders may choose to provide an alternative. The State reserves the right to consider alternate proposals. Alternatives must be detailed in such a way that allows such deviations to be fully evaluated. The State shall determine at its sole discretion whether or not the Bidder's alternative is an acceptable alternative.

This addendum will become part of the ITB and should be acknowledged with the Invitation to Bid.

State of New Hampshire

Department of State

CERTIFICATE

I, William M. Gardner, Secretary of State of the State of New Hampshire, do hereby certify that SEALITE USA, LLC is a Delaware Limited Liability Company registered to transact business in New Hampshire on November 03, 2010. I further certify that all fees and documents required by the Secretary of State's office have been received and is in good standing as far as this office is concerned.

Business ID: 638308



IN TESTIMONY WHEREOF,

I hereto set my hand and cause to be affixed
the Seal of the State of New Hampshire,
this 15th day of November A.D. 2016.

William M. Gardner
Secretary of State

SPAR BUOYS

Regulatory Buoys / Channel Markers



High quality buoy range for Regulatory, Channel or Special marking for harbors, lakes and rivers



Model: SL-B1452

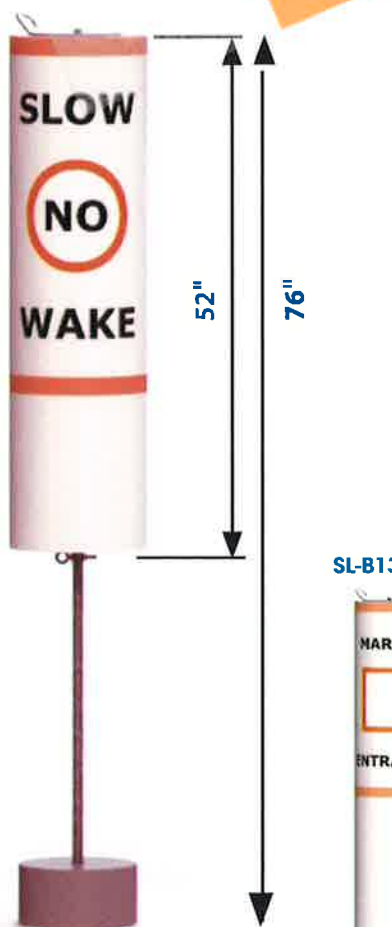

The Sealite Advantage

- Rotationally-molded in one piece using UV-stabilized polyethylene
- Completely foam-filled, virtually unsinkable
- Suitable for extreme weather
- Steel mooring post, provides strength and durability
- Low cost

Available Options

- Available in various heights to suit specific applications
- Optional USCG approved additional reflective band for unmatched night visibility and extreme weather conditions
- Custom line of wraps, vinyl and mold-in graphics
- Optional solar lantern for increased night time visibility

SL-B1362



SL-B1452



SL-B2445



SL-B2460



SPECIFICATIONS*	SL-B1362	SL-B1452	SL-B2445	SL-B2460
Diameter (in/mm)	13/330	14/355.6	24/609	24/609
Overall Height (in/mm)	62/1575	76/1930	45/1143	60/1524
Nominal Freeboard (in/mm)	40.4/1026	40.8/1036	39/995	50.9/1293
Visual Area (ft ² /m ²)	3.3/0.3	3.5/0.32	5.95/0.55	5.95/0.55
Submergence (lb/in; kg/cm)	4.79/0.86	5.55/0.99	16.31/2.92	16.31/2.92
Nominal Draft (in/mm)	48.7/1237	35/889	51.25/1301	64.1/1628
Net weight (lb/kg)	103/46/7	86/39	94.6/43	148/67
Max Mooring Load (lb/kg)	21.2/9.6	27/12	52/23	243/110
Wall Thickness (in/mm)	0.25/5	0.25/5	0.25/5	0.25/5
Solar Lantern (optional)	SL-15, SL-60, SL-70, SL-75	SL-15, SL-60, SL-70, SL-75	SL-15, SL-60, SL-70, SL-75	SL-15, SL-60, SL-70, SL-75

SPAR BUOYS

Mooring Solutions / Configurations



Configuration Options - Mooring

All Sealite Buoys can be moored with traditional chain and sinker or with a cable.
See Mooring Solutions at Sealite.com for details.

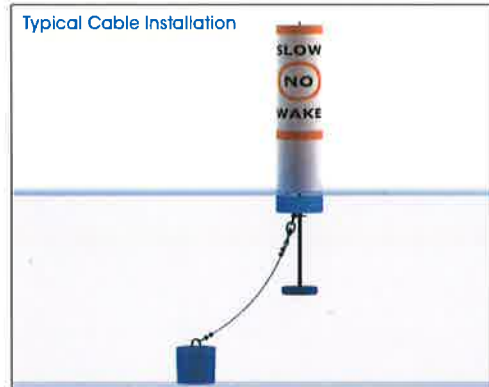
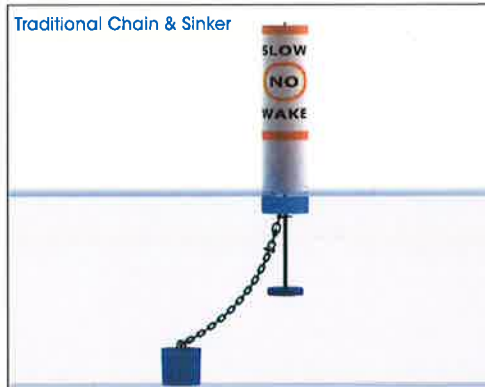

Configuration Options - Applications

Sealite buoys can be custom configured to your needs. Please refer to tables for available options.

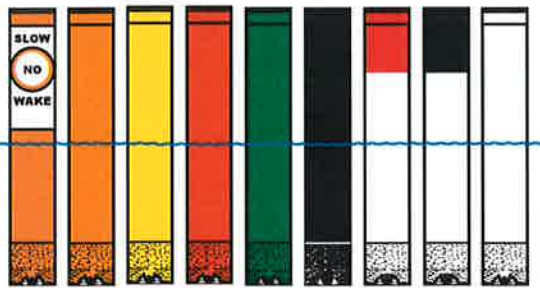

Regulatory Buoys Marker Configurations

- Regulatory buoy: Orange/white
- Hazard buoy: Orange
- Special purpose marks: Yellow

Navigation Channel Marker Configurations

- Channel markers: Red, green or black
- Navigation buoy: White with red top
- Navigation buoy: White with black top

Standard Inland Waterway Symbols and Messages Available

CONTROLLED AREA
STANDARD MESSAGES SLOW NO WAKE IDLE SPEED NO WAKE 5MPH NO WAKE 10MPH NO SKI SKI AREA NO RAFTING

RESTRICTED AREA
STANDARD MESSAGES SWIM AREA KEEP OUT NO BOATS RESTRICTED AREA DANGER KEEP OUT CLOSED AREA

HAZARD WARNING
STANDARD MESSAGES DANGER DANGER DAM ROCK SHOAL HAZARD AREA DANGER PIPELINE CONSTRUCTION

INFORMATION
STANDARD MESSAGES MARINA ENTRANCE FISH ATTRACTOR





Sealite USA LLC
USA
t: +1 (603) 737 1311

Sealite Pty Ltd
Australia
t: +61 (0)3 5977 6128

Sealite United Kingdom Ltd
UK
t: +44 (0) 1502 588026

Sealite Asia Pte Ltd
Singapore
t: +65 6829 2243

Specification Compliance & Comparison

<u>Item of Comparison</u>		<u>Sealite SL-B1452</u> 	<u>Rolyan B1251</u> 	<u>Difference</u>
Specifications	Buoy Height:	52 in.	51 in.	Sealite 2% larger
	Overall Height:	76 in.	73.5 in.	Sealite 3% larger
	Diameter:	14 in.	12 in.	Sealite 17% larger
	Weight	86 lbs.	71 lbs.	Sealite 15 lbs. heavier
	Daymark with 36" exposure:	3.5 ft ²	3 ft ²	Sealite 17% larger
	Exposure without Tackle	40.8 in.	38	Sealite 7% larger
	Mooring tackle allowed for 36" exposure	27 lbs.	7 lbs.	Sealite 2.8 times more
	Draft	35 in.	36 in.	Sealite 2% less
	Submerged Buoyancy	203 lbs.	155 lbs.	Sealite 31% more
	Shell Diameter	0.25 in.	Unknown	Sealite buoys are uniformly molded using rotational molding process which insures consistent thickness to provide uniform strength throughout the entire body of the buoy
	Ballast Attachment	<ul style="list-style-type: none"> ●Galvanized steel pipe ●Self righting without tackle 	<ul style="list-style-type: none"> ●Galvanized steel pipe ●Self righting without tackle 	Identical
Exterior Materials		<ul style="list-style-type: none"> ● Low Linear Density Polyethylene Resin ● UV Inhibitors ●Color is impregnated into the polyethylene so color is carried throughout the entire thickness of the buoy shell 	●ABS plastic	Sealite buoy color will be visible even if buoy suffers vessel collision since color is added to polyethylene materials; color cannot be chafed off
Interior Materials		●Closed cell polyurethane foam	●Urethane foam	Sealite's closed cell polyurethane foam resists water better than standard urethane foam

Recycling Statement & Environmental Impact Statement		<ul style="list-style-type: none"> ●May be returned to our New Hampshire factory at the end of their service life for complete recycling ●No toxic chemicals or heavy metals used in any Sealite buoy manufacturing process 	●None (that Sealite is aware of)	Sealite is an environmentally concious company, meeting section I, item E, in the Nebraska 2017 Bid Number 5628 OF, for Recycling
Quality Statement		Sealite buoys are manufactured in New Hampshire to the highest quality standards available using virgin, UV inhibited polyethylene utilizing a rotationally molded process to insure uniform buoy wall thickness and to provide consistent strength and color throughout the buoy.	n/a	
Sales Support	Hours	8:00 a.m. to 8:00 p.m. EST	Unknown	Sealite prides itself on its outstanding customer service



July 26, 2017

RE: Invitation to Bid Number: 5628 OF

State Purchasing Bureau
1526 K Street, Suite 130
Lincoln, Nebraska 68508
Ph: 402-471-6500

To whom it may concern:

Attached please find the required documents per page 10 of ITB 5628 OF, representing Sealite's bid for 200 Can Buoys.

Sealite has chosen to submit a slight variation (to the advertised size 12x51) because visibility of a 14x52 size buoy will have greater visibility (over a size 12x51) on a body of water the size of Pawnee Lake (740 acres), thus enhancing safety for all users.

The following documents are contained herein:

1. Original completed Commodity ITB form
2. Completed Sections II - VI
3. Form A: Bidder Contact Sheet
4. Addendum One Revised, Questions and Answers
5. Letter of Good Standing from the State of New Hampshire
6. Specification Sheet
7. Specification Compliance/Comparison Sheet
8. State Bid Sheets

Each of the items is numbered for easy identification and comprehension.

Thank you for the opportunity to provide you with Sealite's bid for 14x52 can buoys.

Sincerely,

Tara Stewart
President

We believe technology improves navigation™

SEALITE USA, LLC

61 Business Park Drive, Tilton, New Hampshire 03276, USA

TELEPHONE: +1 (603) 737 1311 FAX: +1 (603) 737 1320 EMAIL: info@sealiteusa.com



NEBRASKA

Good Life. Great Service.

DEPT. OF ADMINISTRATIVE SERVICES



June 28, 2017

Dear Prospective Bidder:

The State of Nebraska Purchasing Bureau is issuing the following Invitation to Bid (ITB):

ITB Number: 5628 OF
Commodity: Can Buoys
Opening Date: August 1, 2017; 2:00 p.m. Central Time
Buyer: Kristen Kosch

Copies of 5628 OF and all information relevant to this ITB to include addenda and/or amendments may be obtained from the State Purchasing Bureau web site at:

<http://das.nebraska.gov/materiel/purchasing.html>

It is the responsibility of the bidder to check this site for other pertinent information and any mandatory requirements. All information relevant to this ITB, to include addenda and/or amendments that may be issued prior to the opening date, will be posted to the website.

ITB responses must be in a sealed envelope that indicates the ITB Number and Opening Date. Sealed responses must be received in the State Purchasing Bureau on or before August 1, 2017; 2:00 p.m. Central Time, at which time responses will be publicly opened. ITB response must be sent to:

State Purchasing Bureau
1526 K Street, Suite 130
Lincoln, NE 68508

Any problems accessing the website regarding the above ITB should be e-mailed or faxed to the State Purchasing Bureau at as.materielpurchasing@nebraska.gov or 402-471-2089.

Sincerely,

A handwritten signature in blue ink, appearing to read "Kristen Kosch", is positioned below the word "Sincerely,".

Kristen Kosch, Buyer
State Purchasing Bureau

Bo Botelho, Chief Operations Officer

Department of Administrative Services | MATERIEL DIVISION

1526 K Street, Ste. 130
Lincoln, Nebraska 68508

OFFICE 402-471-0972
FAX 402-471-2089

das.nebraska.org

ADDENDUM ONE REVISED, QUESTIONS and ANSWERS

Date: July 14, 2017
To: All Bidders
From: Kristen Kosch, Buyer
AS Materiel State Purchasing Bureau
RE: Addendum for Invitation to Bid Number 5628 OF
to be opened August 01, 2017 at 2:00 p.m. Central Time

Questions and Answers

Following are the questions submitted and answers provided for the above mentioned Invitation to Bid. The questions and answers are to be considered as part of the Invitation to Bid. It is the Bidder's responsibility to check the State Purchasing Bureau website for all addenda or amendments.

<u>Question Number</u>	<u>Question</u>	<u>State Response</u>
1.	Will you accept bids from companies who manufacture identical and/or similar buoy products to those specified as long as they meet the identified specifications in ITB?	The State of Nebraska has restricted this bid to the brand and models stated, based on using agency requirements. Bidders may choose to provide an alternative. The State reserves the right to consider alternate proposals. Alternatives must be detailed in such a way that allows such deviations to be fully evaluated. The State shall determine at its sole discretion whether or not the Bidder's alternative is an acceptable alternative.

This addendum will become part of the ITB and should be acknowledged with the Invitation to Bid.

State of Nebraska - INVITATION TO BID CONTRACT

Return to:
State Purchasing Bureau
1526 K Street, Suite 130
Lincoln, Nebraska 68508

Telephone: 402-471-6500
Fax: 402-471-2089

Date	6/13/17	Page	1 of 1
Solicitation Number	5628 OF		
Opening Date and Time	07/12/17	2:00 pm	
Buyer	KRISTEN KOSCH (AS)		

DESTINATION OF GOODS

**GAME & PARKS COMMISSION
PAWNEE SRA
C/O PARK SUP'T
3800 NW 105TH ST
LINCOLN NE 68524-8816**

Per Nebraska's Transparency in Government Procurement Act, DAS is required to collect statistical information regarding the number of contracts awarded to Nebraska contractors. This information is for statistical purposes only and will not be considered for contract award purposes.

____ NEBRASKA CONTRACTOR AFFADAVIT: Bidder hereby attests that bidder is a Nebraska Contractor. " Nebraska Contractor" shall mean any bidder who has maintained a bona fide place of business and at least one employee within this state for at least the six (6) months immediately preceding the posting date of this ITB.

____ I hereby certify that I am a Resident disabled veteran or business located in a designated enterprise zone in accordance with Neb. Rev. Stat. §73-107 and wish to have preference, if applicable, considered in the award of this contract.

Contract to supply and deliver Can Buoys to the State of Nebraska as per the attached specifications for a one (1) year period from date of award. The contract may be renewed for four (4) additional one (1) year periods when mutually agreeable to the vendor and the State of Nebraska.

(vc 06/12/17)

INVITATION

Line	Description	Quantity	Unit of Measure	Unit Price	Extended Price
1	CAN BUOY 12X51 Make: _____ Model: _____	128.0000	EA	_____	_____

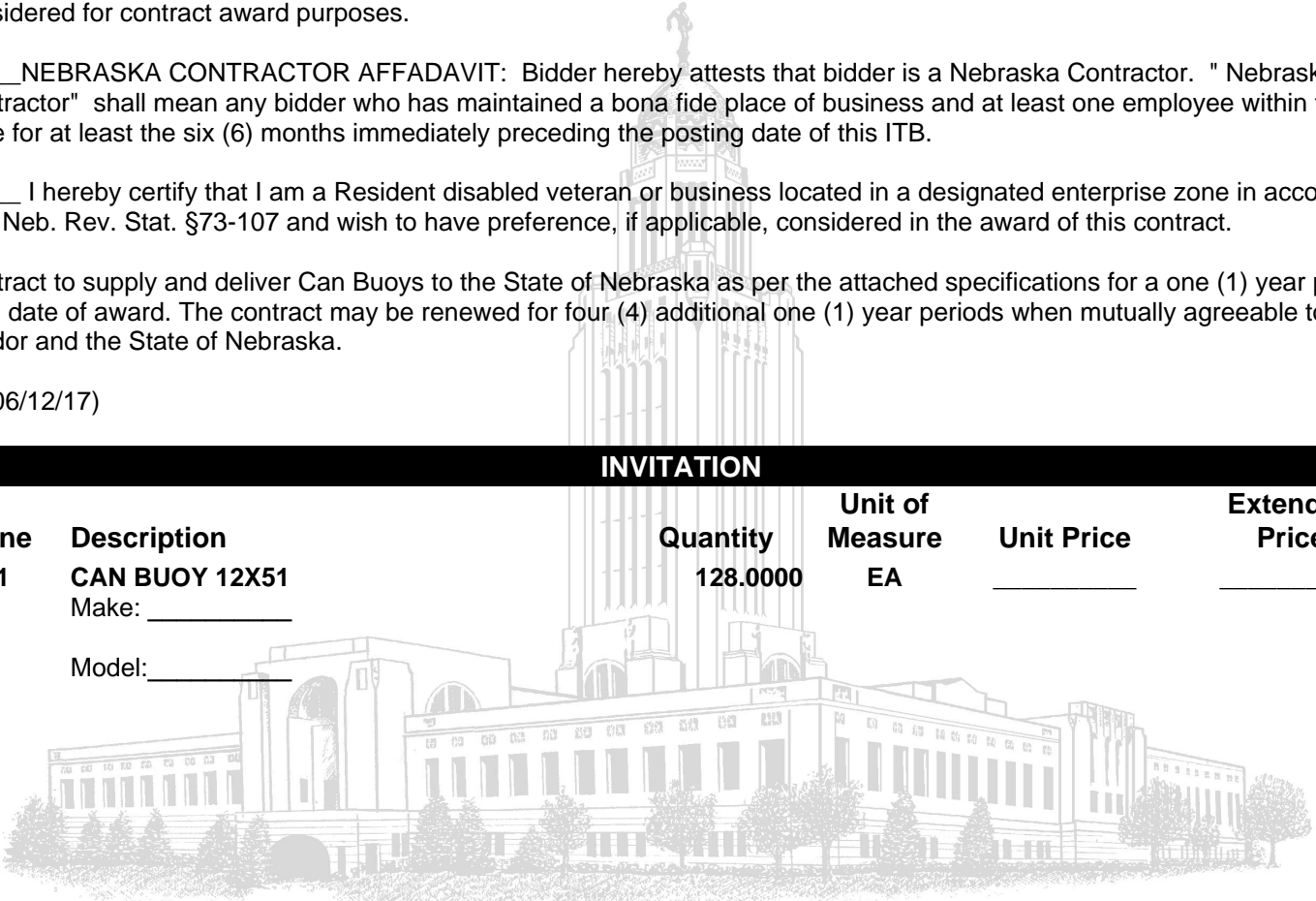

BIDDER MUST COMPLETE THE FOLLOWING

DISCOUNT PAYMENT TERMS: _____% _____ DAYS

By signing this Invitation to Bid form, the bidder guarantees compliance with the provisions stated in this Invitation to Bid, agrees to the terms and conditions unless otherwise agreed to (see Section III) and certifies that bidder maintains a drug free work place environment. Vendor will furnish the items requested within _____ days after receipt of order. Failure to enter Delivery Date may cause quotation to be REJECTED.

Sign _____
Here (Authorized Signature MANDATORY - MUST BE SIGNED IN INK)

Enter Contact Information Below

VENDOR# _____
VENDOR: _____
Address: _____

Contact _____
Telephone _____
Facsimile _____
Email _____