



SCHOOL OF NATURAL RESOURCES

Nebraska sportspersons

NGPC

Chizinski Lab, Kevin Pope, TJ Fontaine
University of Nebraska-Lincoln
2018-12-03

National FWS Survey

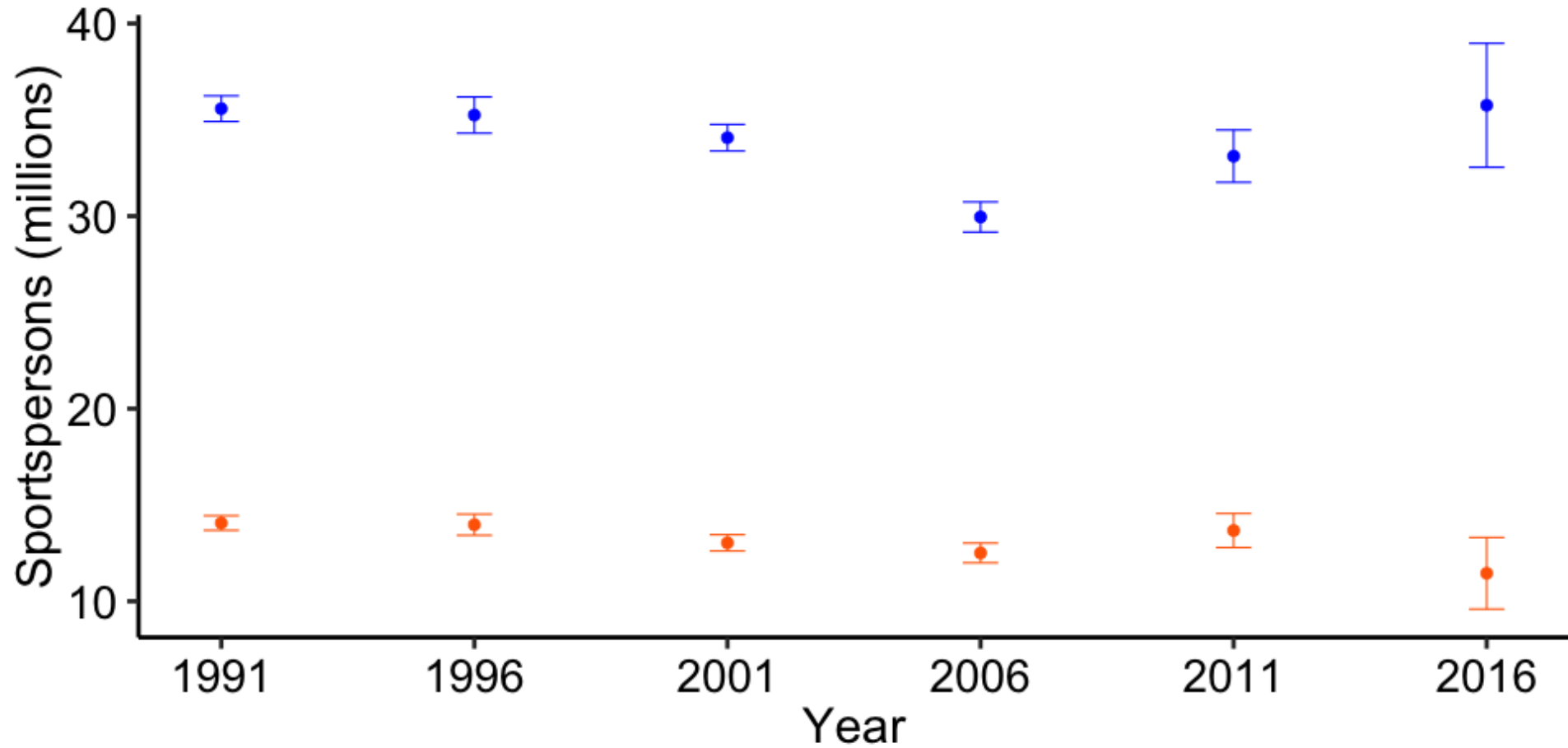

National FWS Survey

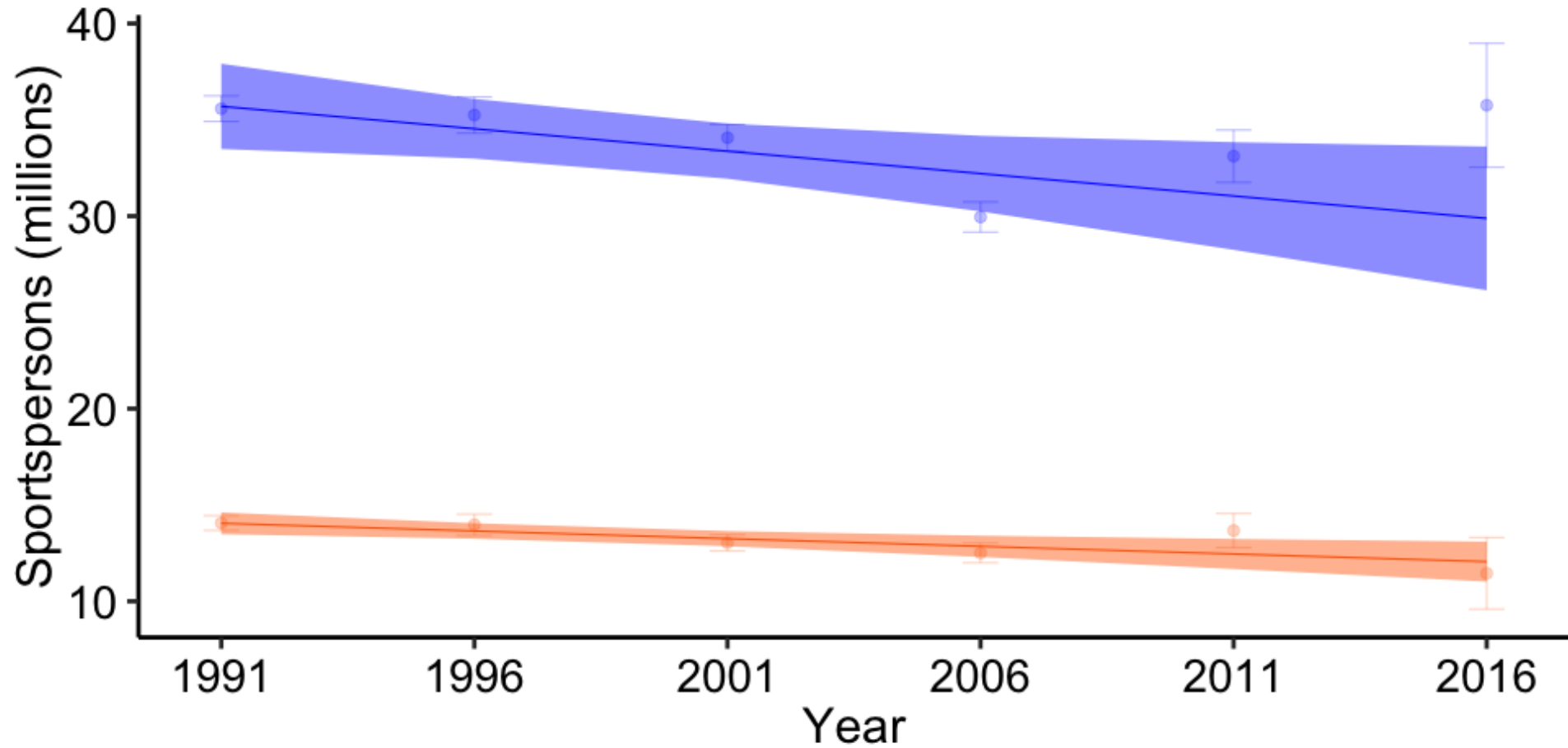

Why we should be concerned?



Fundamental need to understand sportspersons



What can we do?

- Survey! Survey! Survey!

What can we do?

- Survey! Survey! Survey!

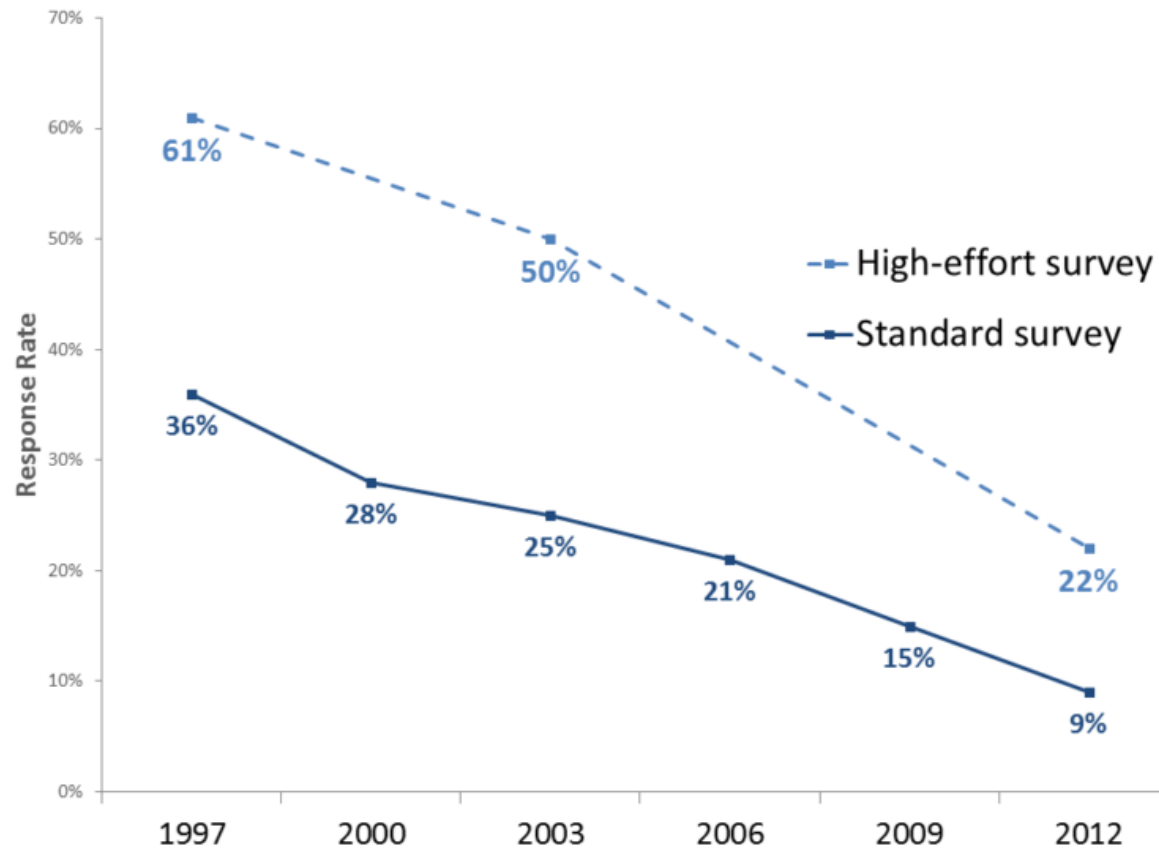

Source: Pew Research Center

What can we do?



Collecting information

The screenshot shows the Nebraska Game and Parks website interface. At the top, there are navigation links for "OUTDOOR NEBRASKA", "RESERVATIONS", and "MOBILE PERMITS". The main header features the "NEBRASKA - GAME & PARKS" logo and a shopping cart icon showing "\$0.00 Proceed to Checkout". Below the header is a navigation bar with buttons for "Shop for Permits", "Remaining Permits", "My Profile", "Hunter Ed", "Draw Results", and "Friends/Family". A search bar is present with fields for "Last Name", "Date of Birth (mm/dd/yyyy)", and "Last 4 Digits of SSN", along with "Click for Help" and "Login or Create New Profile" buttons.

A prominent orange-bordered notification box contains the following text:

⚠️ ++++++2018 Paddlefish Application Process+++++ Permit fees are \$33 for residents and \$57 for nonresidents. Starting this year, \$7 of that fee is due at the time of application. The remainder (\$26 for residents, \$50 for nonresidents) is due, if a permit is awarded, within 15 days of draw notification. Anglers can apply online for a Paddlefish application by using the new Permits system or Paper applications will still be accepted by mailing them to the Nebraska Game and Parks Commission, P.O. Box 30370, Lincoln Nebraska 68503. Mailed applications must be received in the Lincoln office by 5:00 pm on the last day of the application period. Online applications end at midnight on March 14, 2018.

Below the notification, there is a list of permit categories with expandable arrows:

- Park Permits
- Senior and Veteran Permits
- Hunt and Combo Permits
- Fish and Combo Permits
- Deer Permits
- Turkey Permits

Collecting information

- Track individual customers
 - over time
 - over space
- Identify permit purchase patterns
- Up-to-date information
- Lessen burden from surveys

The screenshot shows the Nebraska Game and Parks website interface. At the top, there are navigation links for "OUTDOOR NEBRASKA", "RESERVATIONS", and "MOBILE PERMITS". The main header features the "NEBRASKA - GAME & PARKS" logo and payment options for VISA, MasterCard, and DISCOVER. A shopping cart icon indicates a total of \$0.00 and a "Proceed to Checkout" button.

Below the header, there are navigation buttons: "Shop for Permits", "Remaining Permits", "My Profile", "Hunter Ed", "Draw Results", and "Friends/Family". A search bar is present with fields for "Last Name", "Date of Birth (mm/dd/yyyy)", and "Last 4 Digits of SSN", along with "Click for Help" and "Login or Create New Profile" buttons.

A prominent orange-bordered notification box contains the following text:

 ++++++2018 Paddlefish Application Process+++++ Permit fees are \$33 for residents and \$57 for nonresidents. Starting this year, \$7 of that fee is due at the time of application. The remainder (\$26 for residents, \$50 for nonresidents) is due, if a permit is awarded, within 15 days of draw notification. Anglers can apply online for a Paddlefish application by using the new Permits system or Paper applications will still be accepted by mailing them to the Nebraska Game and Parks Commission, P.O. Box 30370, Lincoln Nebraska 68503. Mailed applications must be received in the Lincoln office by 5:00 pm on the last day of the application period. Online applications end at midnight on March 14, 2018.

Below the notification, a menu lists various permit categories with corresponding icons:

- ▶ Park Permits
- ▶ Senior and Veteran Permits
- ▶ Hunt and Combo Permits
- ▶ Fish and Combo Permits
- ▶ Deer Permits
- ▶ Turkey Permits

Collecting information

- Track individual customers
 - over time
 - over space
- Identify permit purchase patterns
- Up-to-date information
- Lessen burden from surveys



 The screenshot shows the Nebraska Game and Parks website interface. At the top, there are navigation links for 'OUTDOOR NEBRASKA', 'RESERVATIONS', and 'MOBILE PERMITS'. The main header features the 'NEBRASKA - GAME & PARKS' logo and payment options for VISA, MasterCard, and DISCOVER. A shopping cart icon shows '\$0.00 Proceed to Checkout'. Below the header is a navigation bar with buttons for 'Shop for Permits', 'Remaining Permits', 'My Profile', 'Hunter Ed', 'Draw Results', and 'Friends/Family'. A search bar contains 'Click for Help' and fields for 'Last Name', 'Date of Birth (mm/dd/yyyy)', and 'Last 4 Digits of SSN'. A 'Login or Create New Profile' button is also present. A prominent orange-bordered warning box contains the following text:

+++++2018 Paddlefish Application Process+++++ Permit fees are \$33 for residents and \$57 for nonresidents. Starting this year, \$7 of that fee is due at the time of application. The remainder (\$26 for residents, \$50 for nonresidents) is due, if a permit is awarded, within 15 days of draw notification. Anglers can apply online for a Paddlefish application by using the new Permits system or Paper applications will still be accepted by mailing them to the Nebraska Game and Parks Commission, P.O. Box 30370, Lincoln Nebraska 68503. Mailed applications must be received in the Lincoln office by 5:00 pm on the last day of the application period. Online applications end at midnight on March 14, 2018.

 Below the warning box is a list of permit categories with expandable arrows:

- Park Permits
- Senior and Veteran Permits
- Hunt and Combo Permits
- Fish and Combo Permits
- Deer Permits
- Turkey Permits

UNL Sportsperson database project

Project objectives:

1. Compile and merge available data sets of Nebraska sportspersons and park users.
2. Identify and assess associations and key demographic factors among license holders.
3. Analyze data sets to identify key differences and movements among sportsperson groups.
4. Develop decision-support tools that give insight into how fish and wildlife managers can direct management and recruitment and retention efforts to maximize participation in Nebraska.

Limitations of databases

- Limited by the information we collect
 - don't collect a lot of demographic information (limited to gender, age, location)
- Quality of databases
 - a **LOT** of bad email addresses
 - 40-60% provide email
 - 10-20% of those are bad email addresses
 - only as good as our unique customer ids
- Don't tell us the *WHYS*

What can we learn about Nebraska sportspersons from our permit database?

Nebraska Sportspersons Deer permits

Female permit holders



11.2 %

95.7 K

Permit holders

Change from 2016



2.7%

Resident permit holders

85.7 %

Permit holders per 100 residents

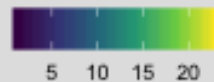
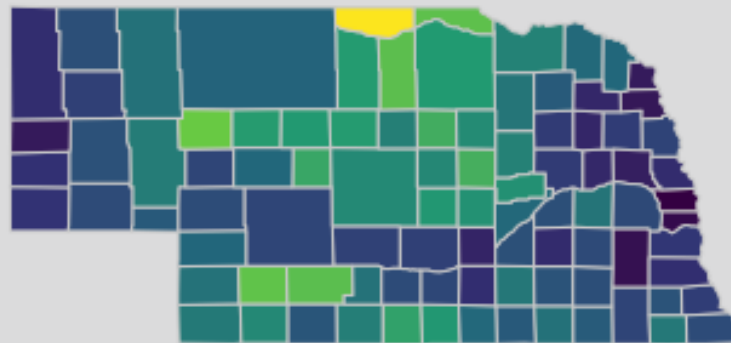

Other permits purchased

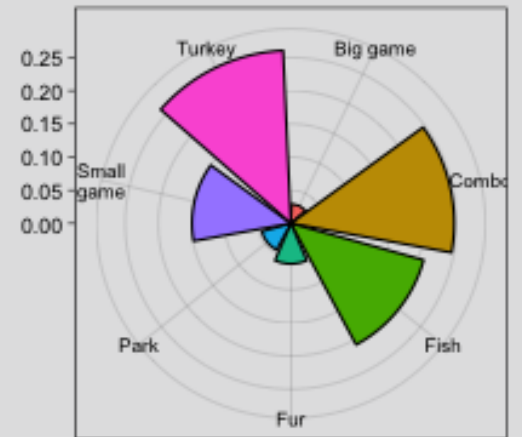

Nebraska Sportspersons Fish Annual+ permits

Female permit holders



28.6 %

122.3 K

Permit holders

Change from 2016



3.3%

Resident permit holders

94.1 %

Permit holders per 100 residents

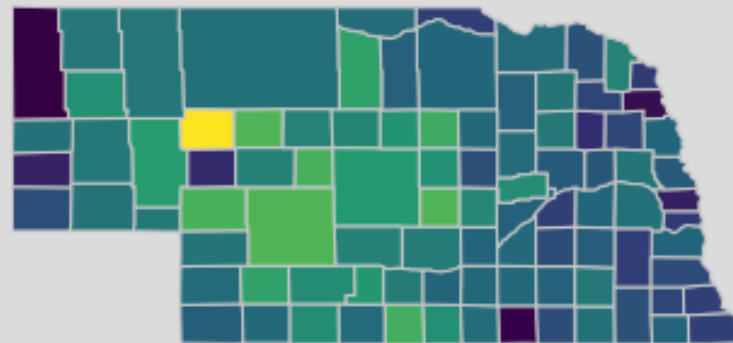

Other permits purchased

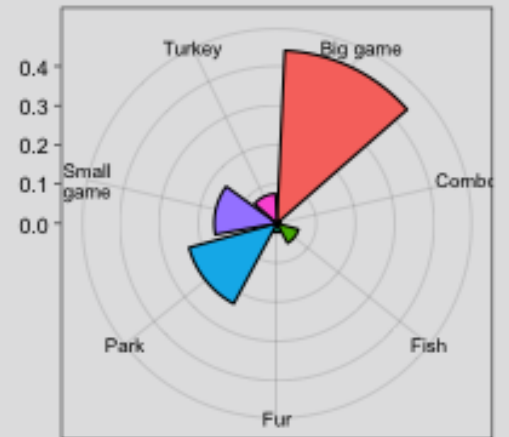

Nebraska Sportspersons Fish Daily permits

Female permit holders



26.6 %

36.9 K

Permit holders

Change from 2016



2.9%

Resident permit holders

39.4 %

Permit holders per 100 residents

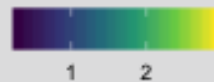
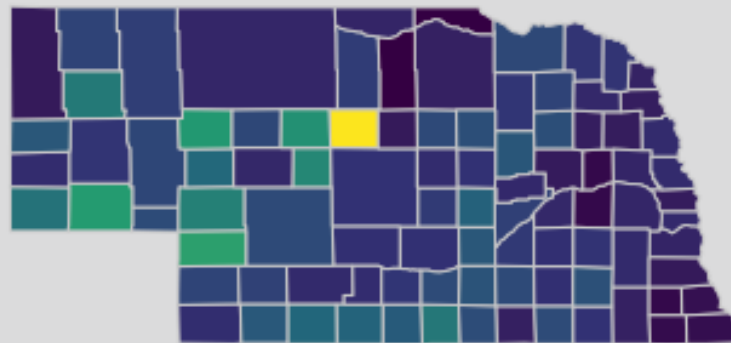

Other permits purchased

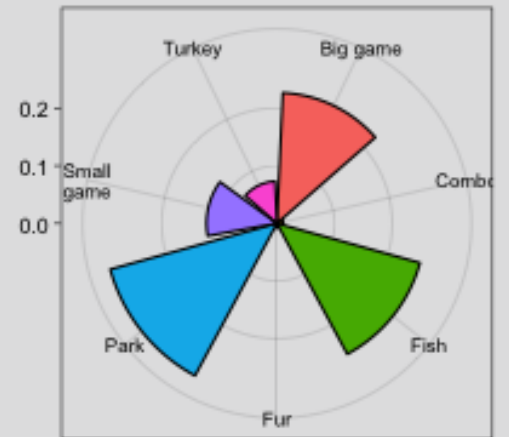

Nebraska Sportspersons Hunt Fish Combo permits

Female permit holders



10.7 %

50.2 K

Permit holders

Change from 2016



4.4%

Resident permit holders

98.3 %

Permit holders per 100 residents

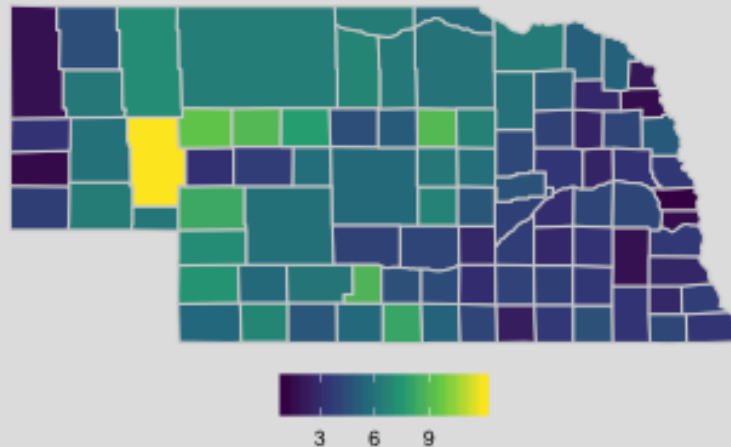

Other permits purchased



Nebraska Sportspersons Hunt permits

Female permit holders



38.7 K

Permit holders

Change from 2016



Resident permit holders

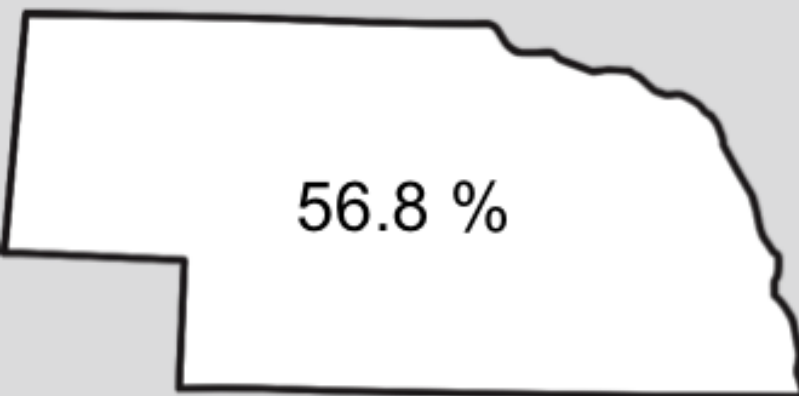

Permit holders per 100 residents

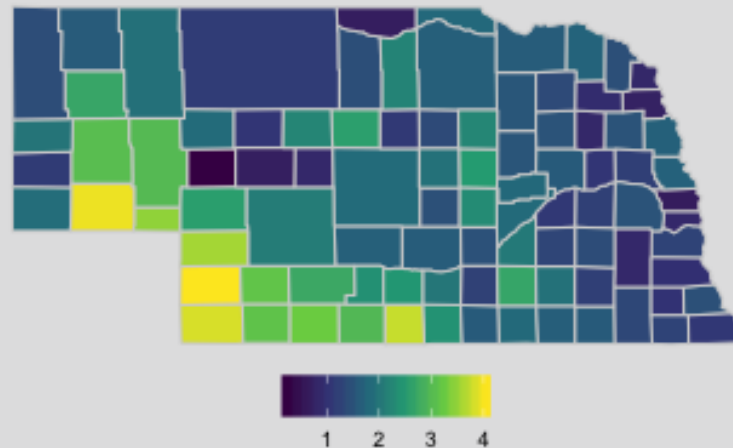

Other permits purchased



Nebraska Sportspersons Turkey permits

Female permit holders



30 K

Permit holders

Change from 2016



Resident permit holders

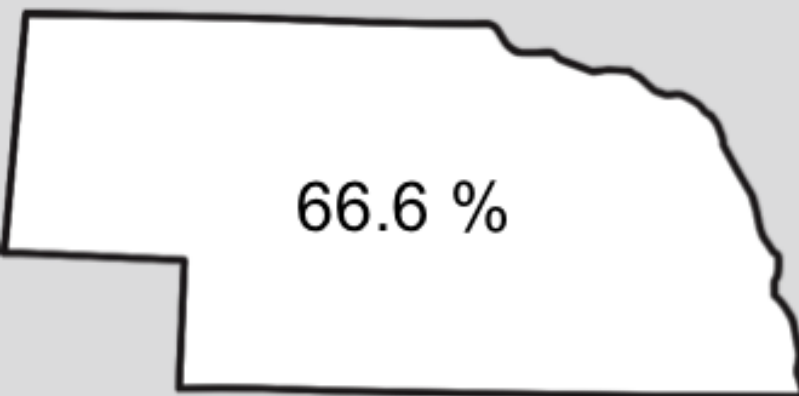

Permit holders per 100 residents

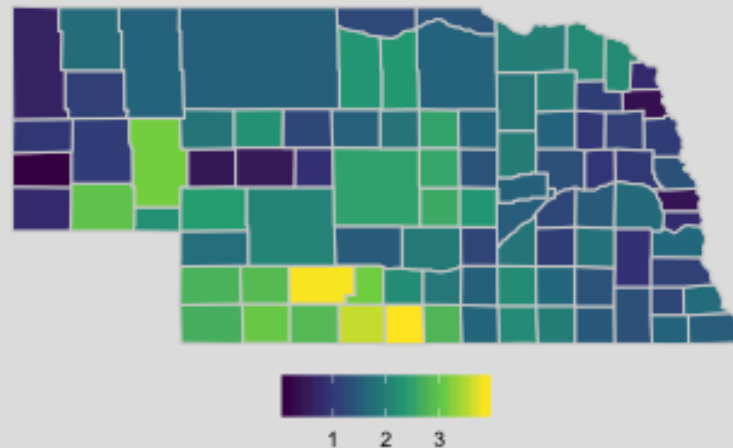

Other permits purchased

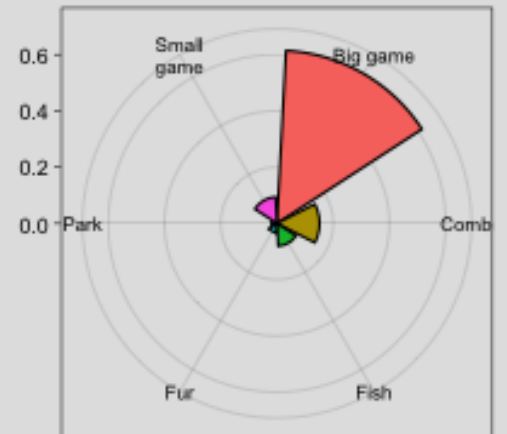

Nebraska Sportspersons For Harvest permits

Female permit holders



6.3 K

Permit holders

Change from 2016



Resident permit holders

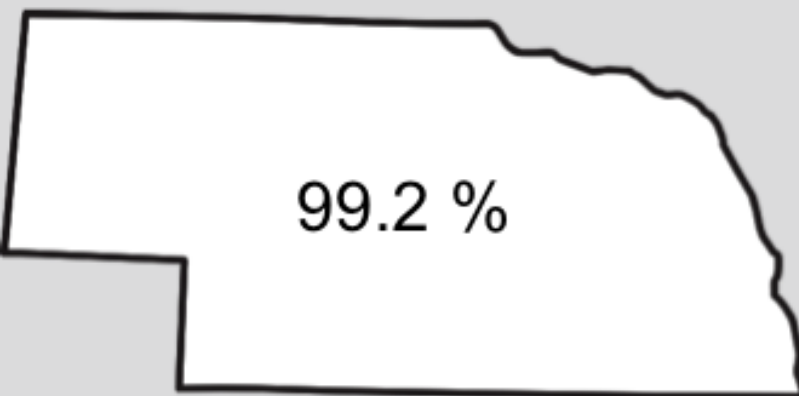

Permit holders per 100 residents

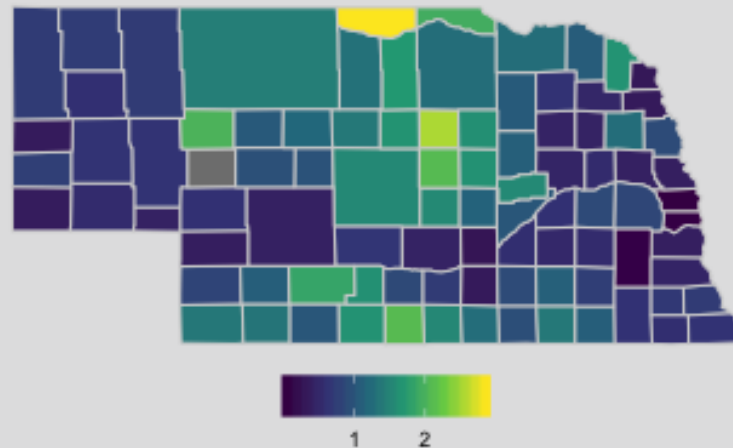

Other permits purchased

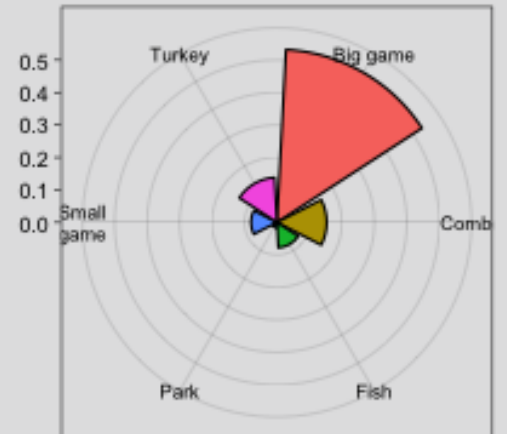

Nebraska Sportspersons Park permits

Female permit holders



108.5 K

Permit holders

Change from 2016



Resident permit holders

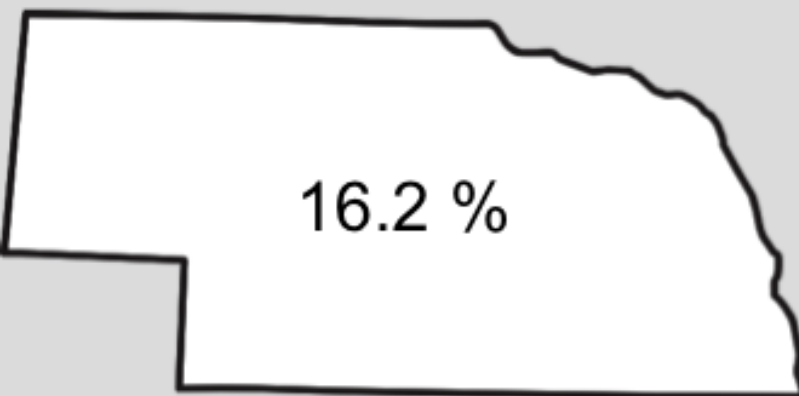

Permit holders per 100 residents

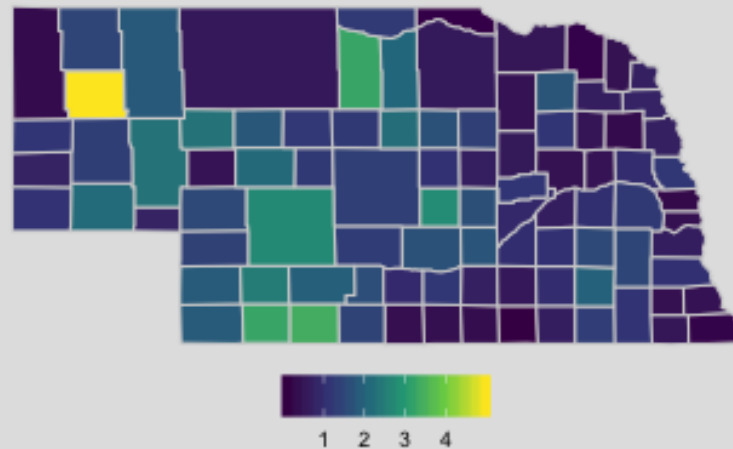

Other permits purchased

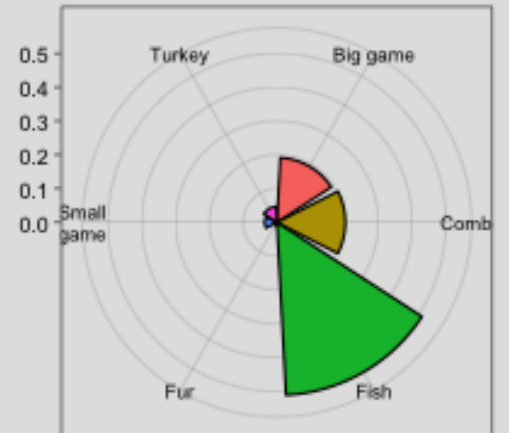

How are these permits changing over time?

Deer permits

Deer permits

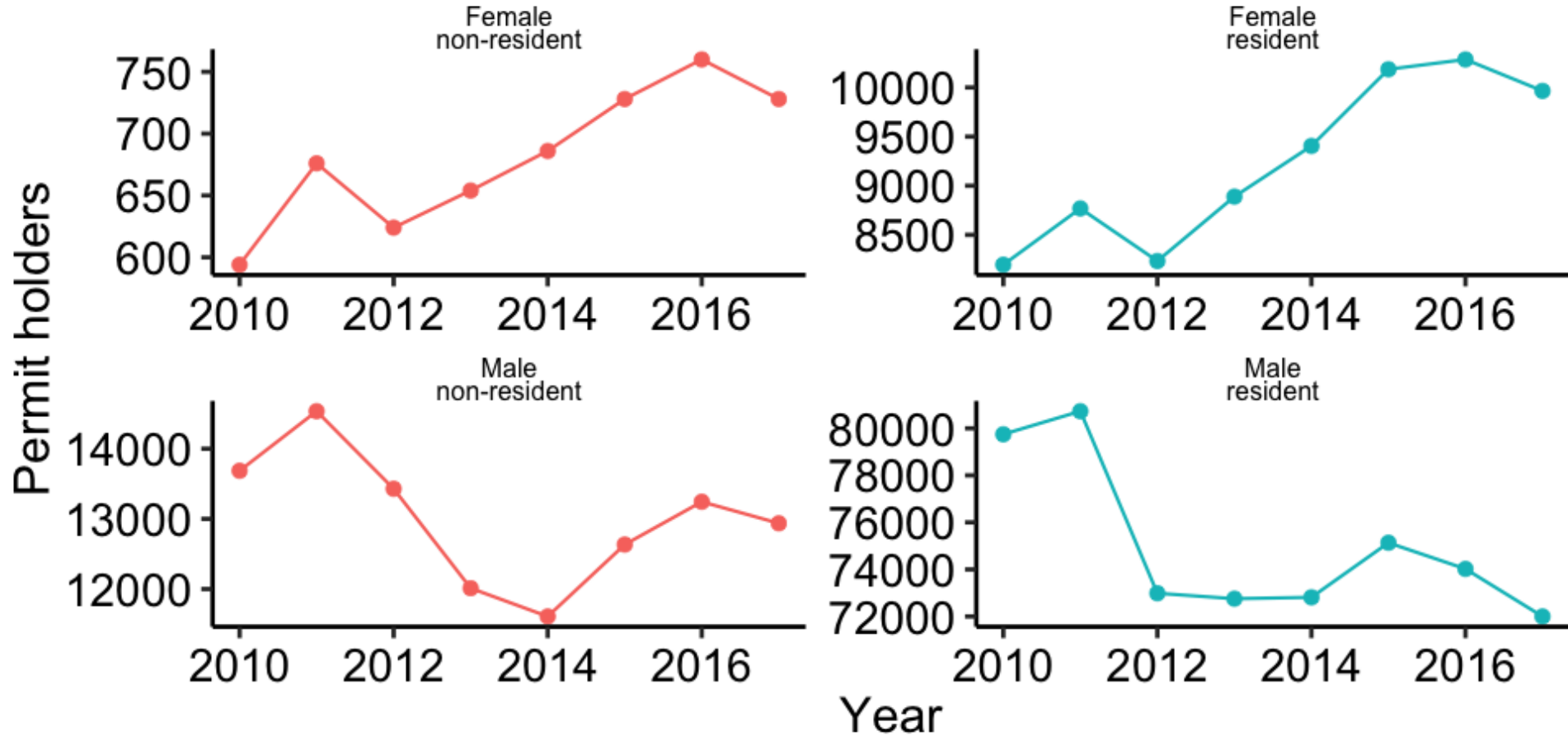

Deer permits

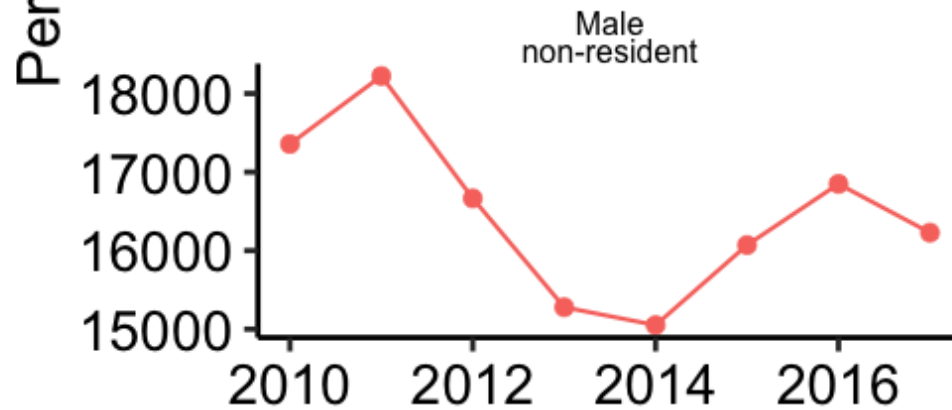
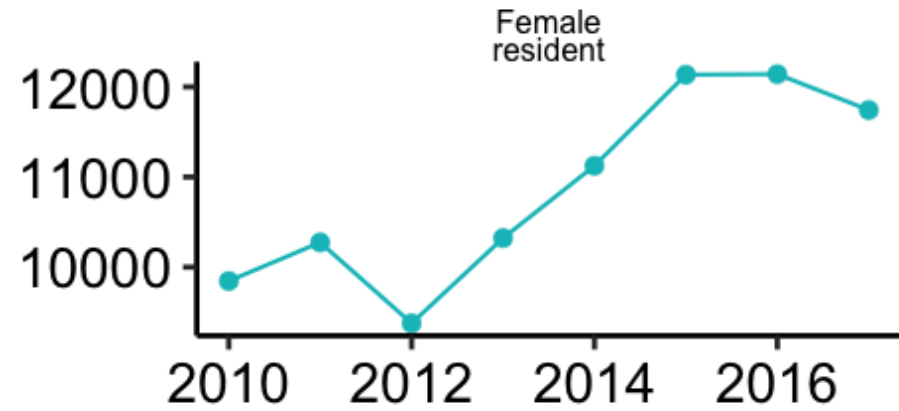
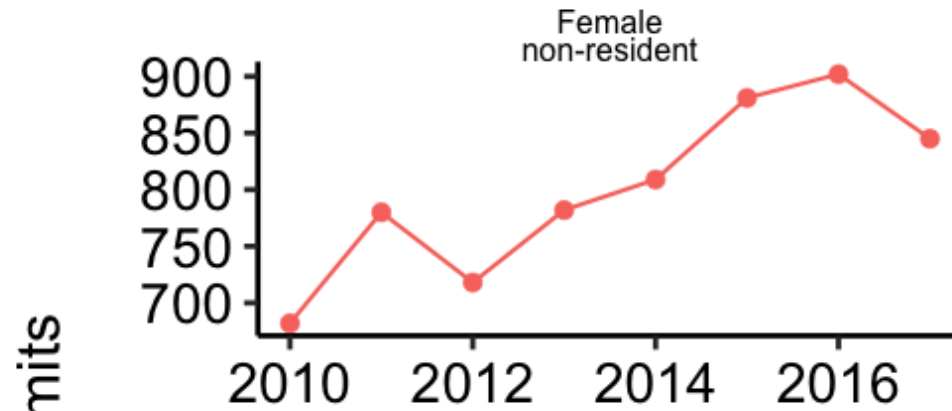

Year

Deer permits

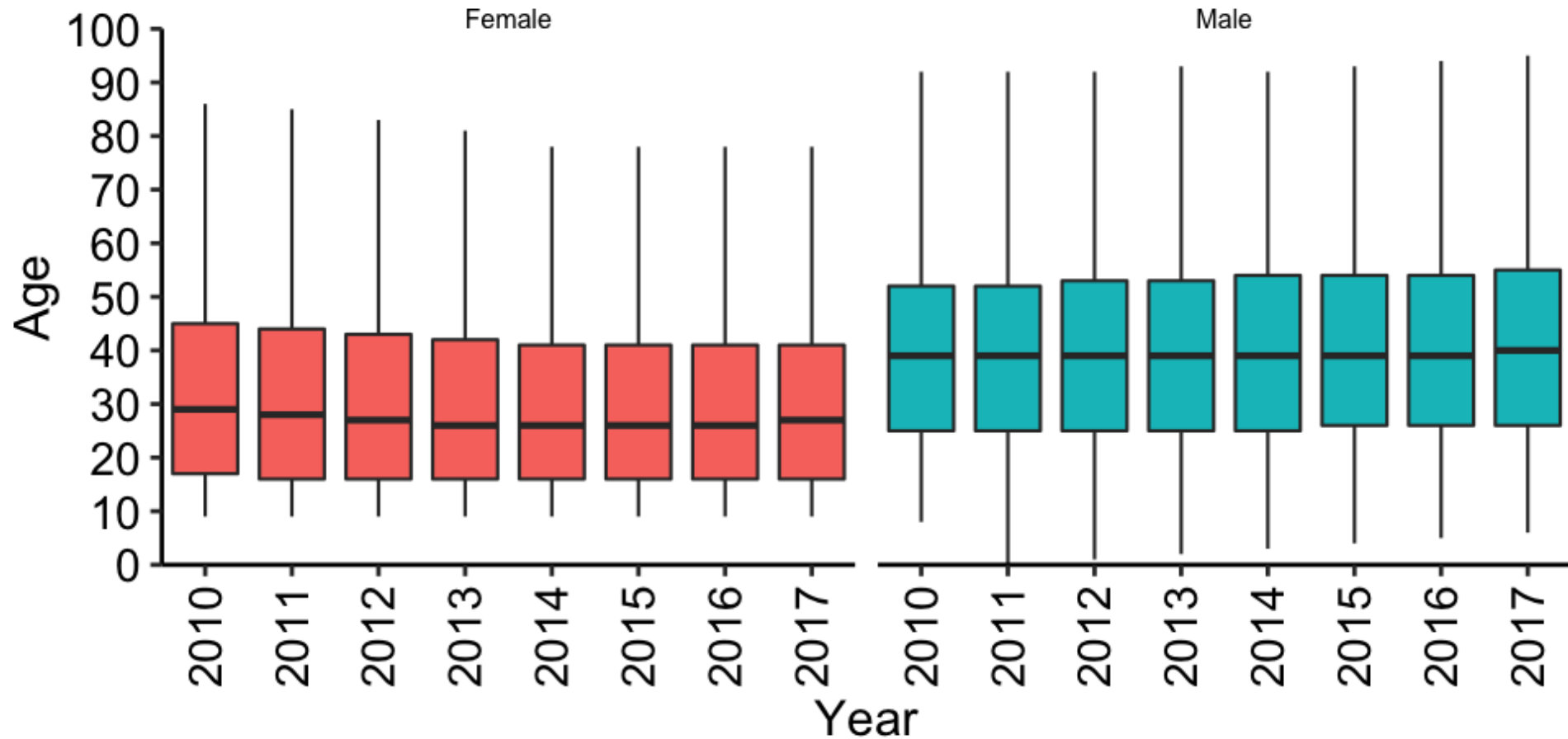

Fish (Annual +) permits

Fish Annual+ permits

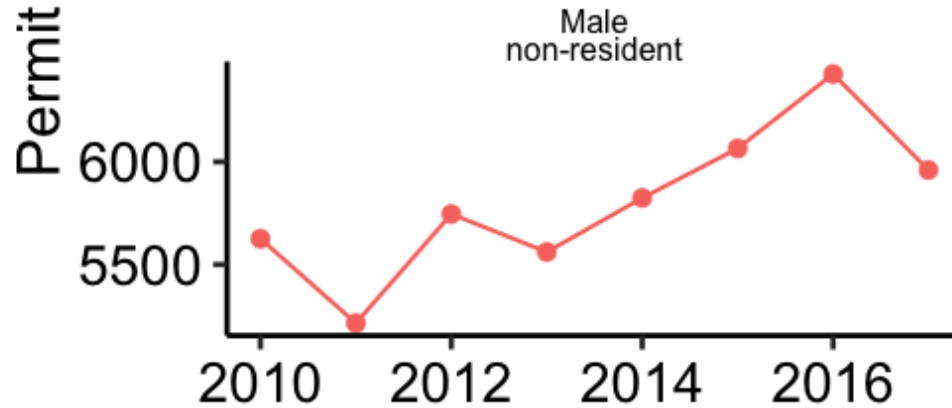
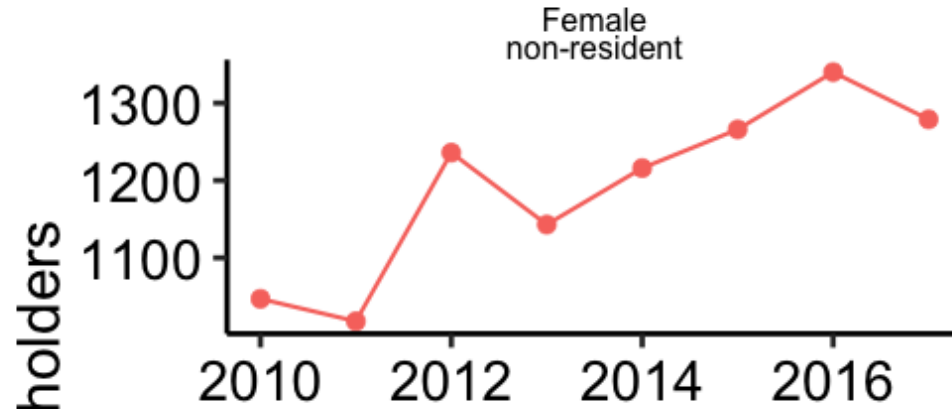

Year

Fish Annual+ permits

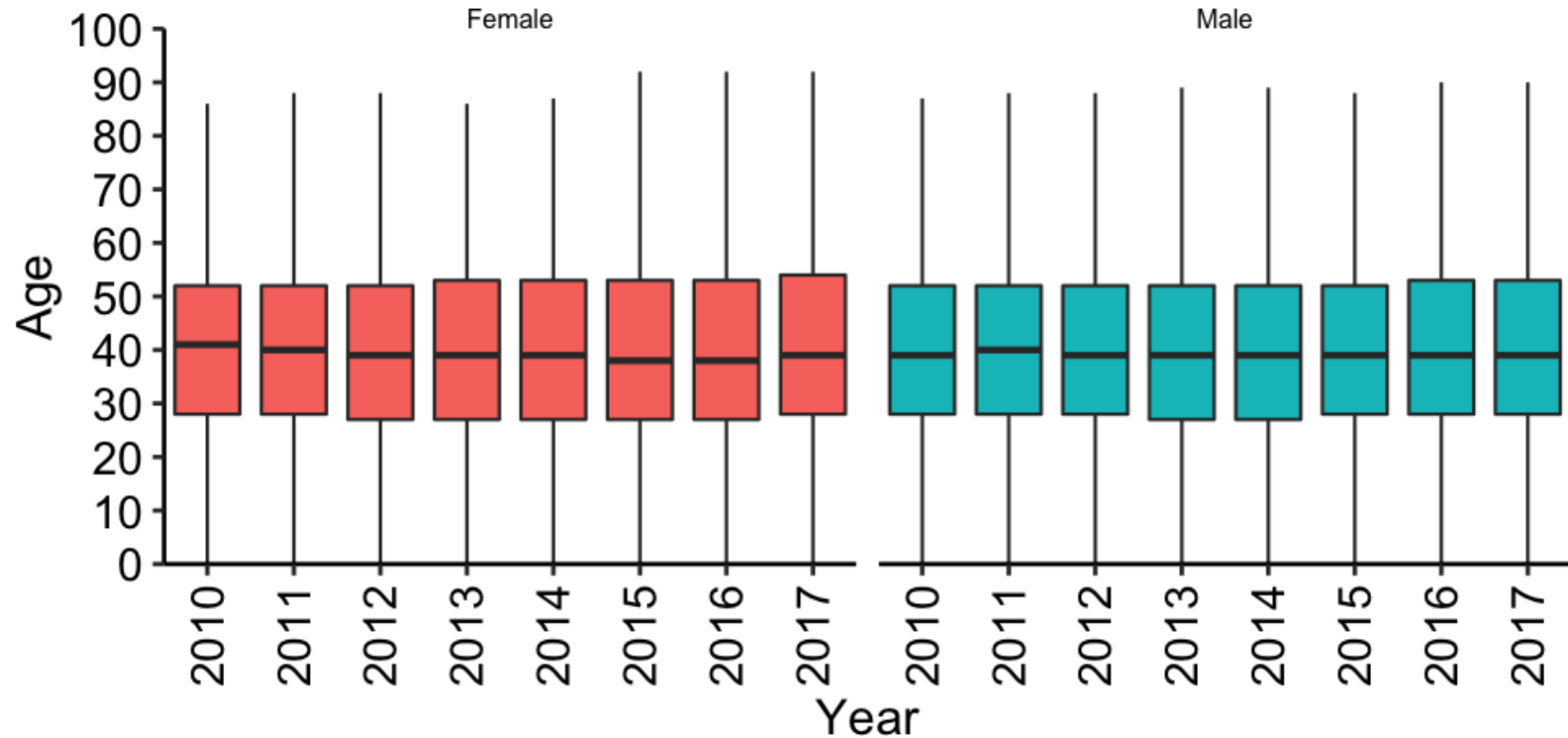

Fish (Daily) permits

Fish Daily permits

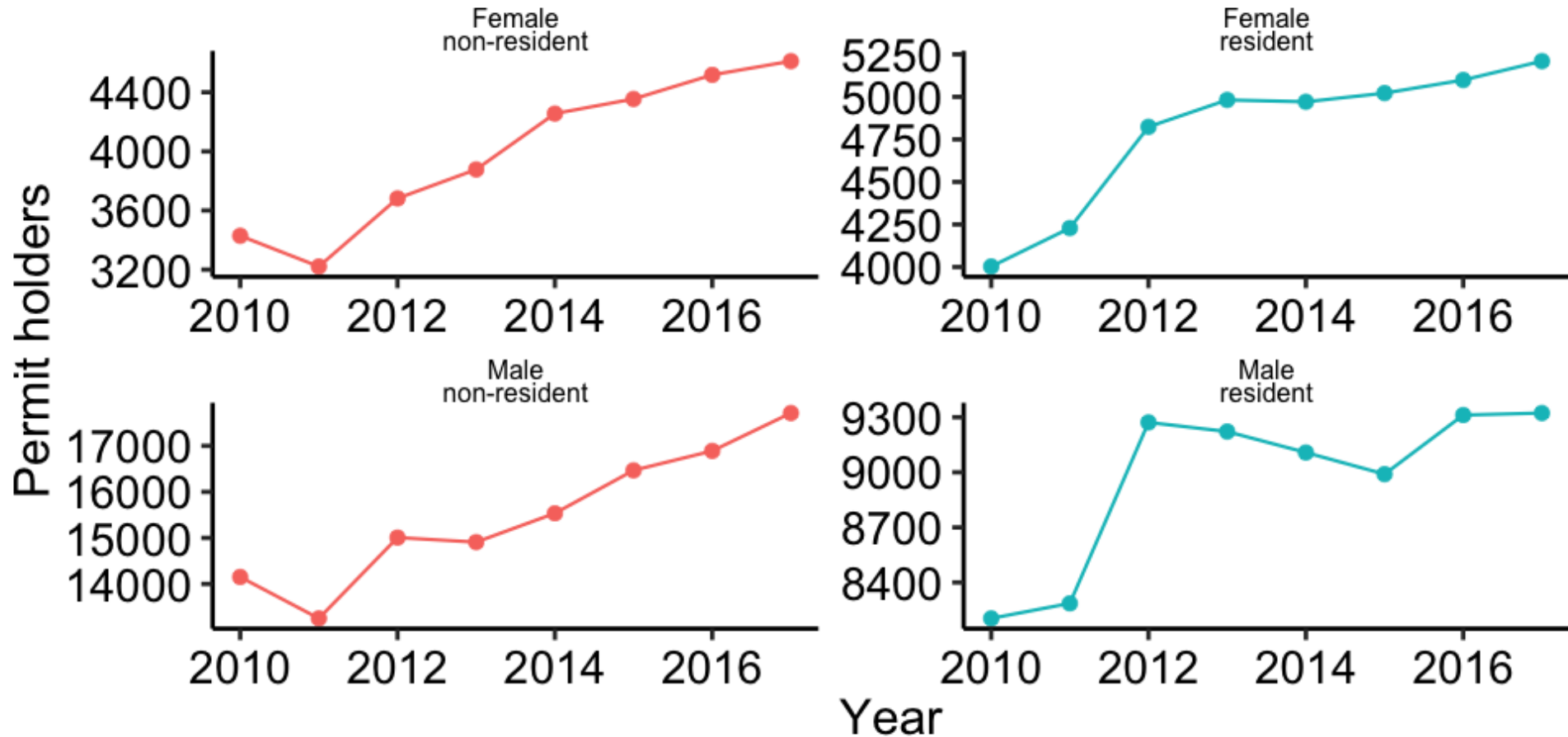

Fish Daily permits

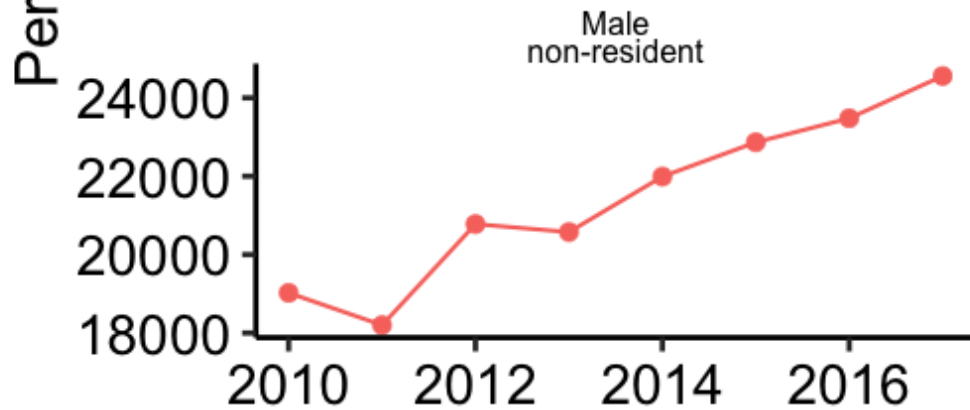
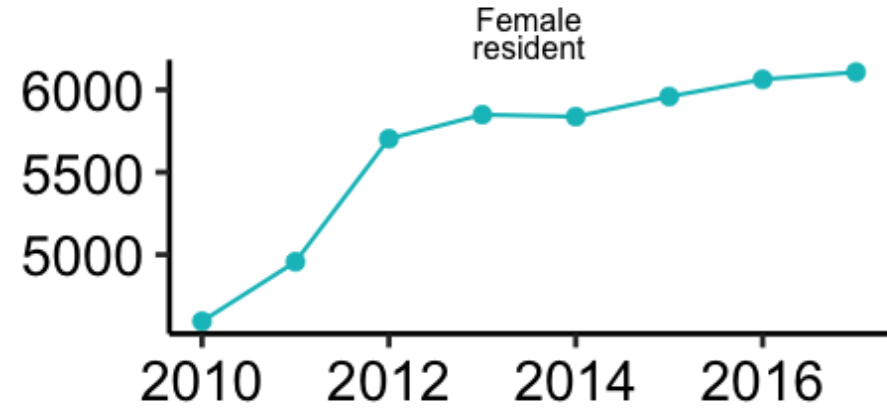
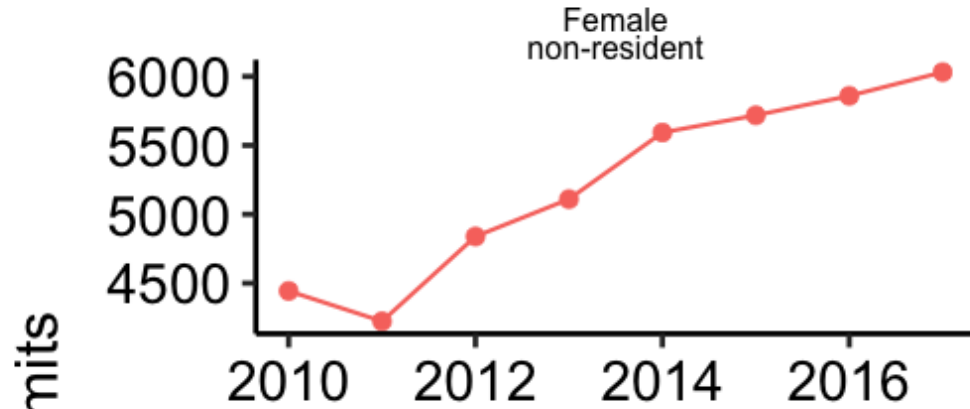

Year

Fish Daily permits

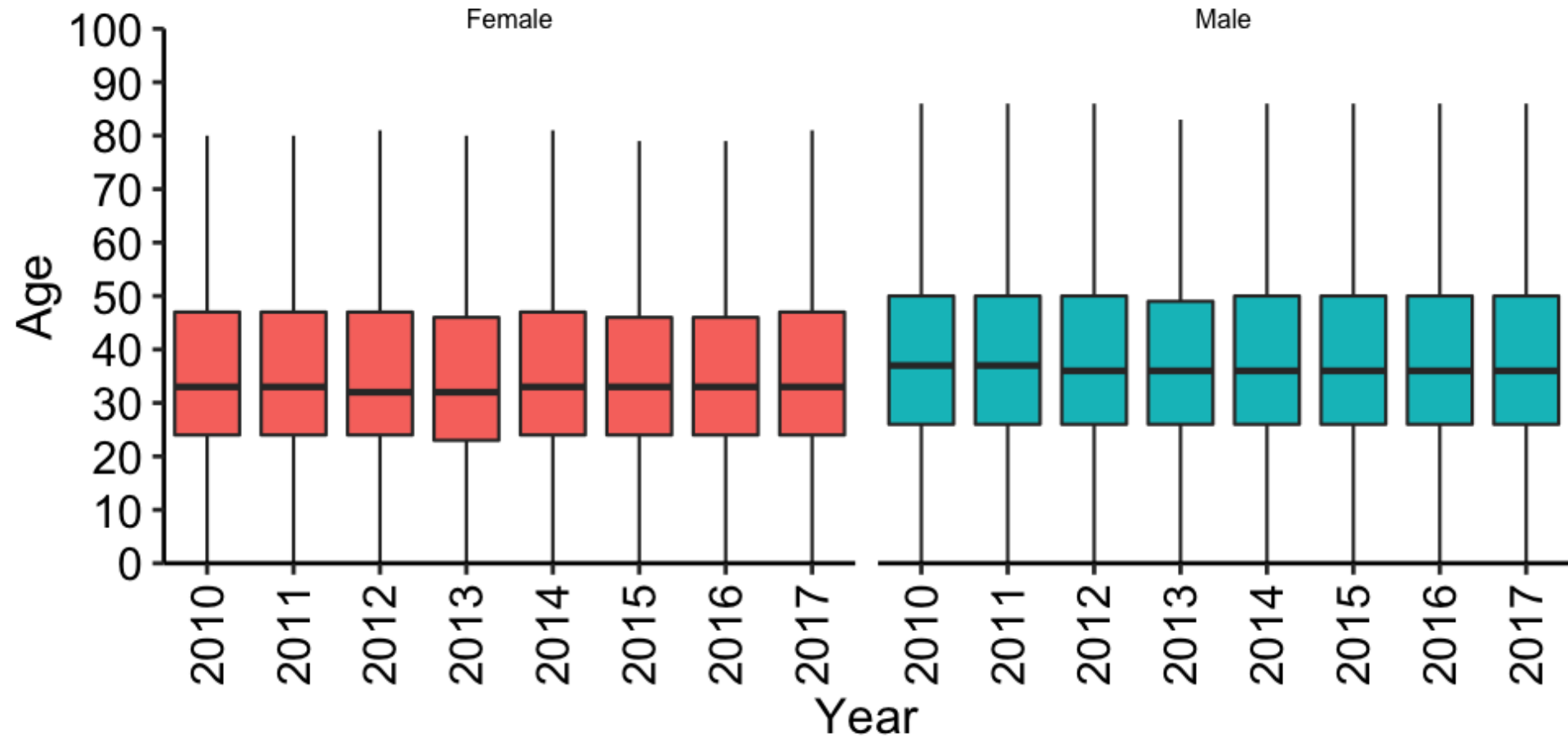

Fish Hunt Combination permits

Fish Hunt Combination permits

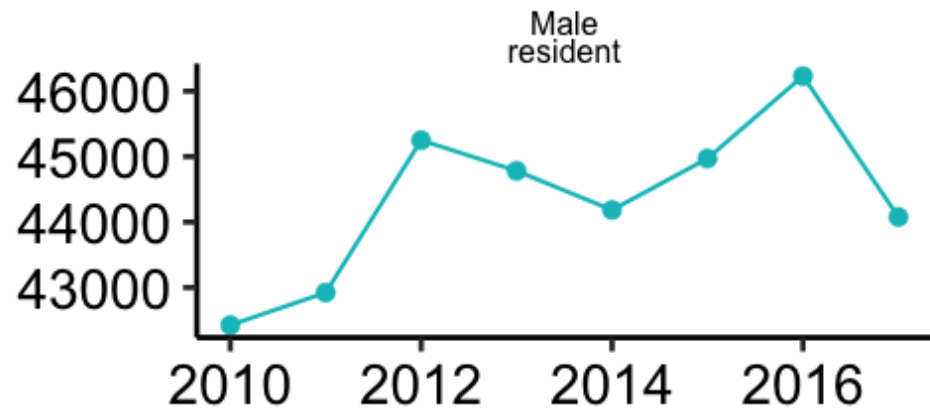
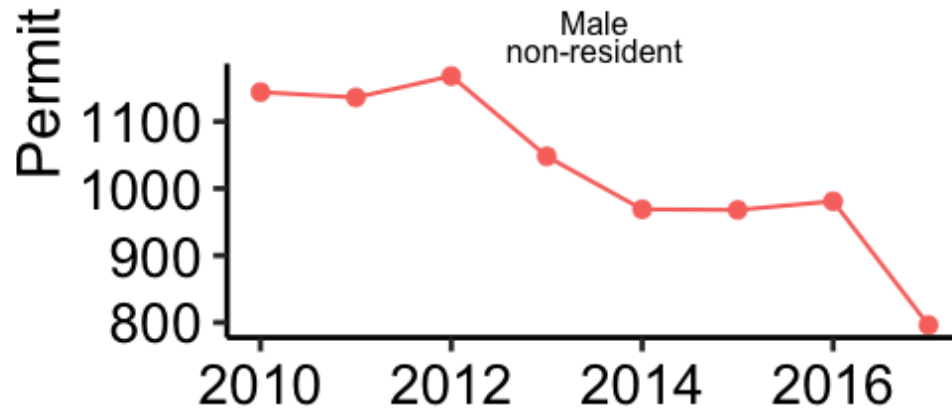
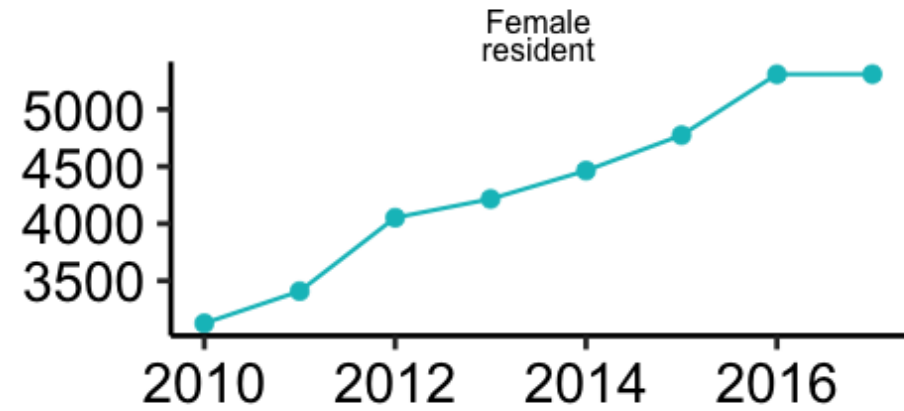

Year

Fish Hunt Combination permits

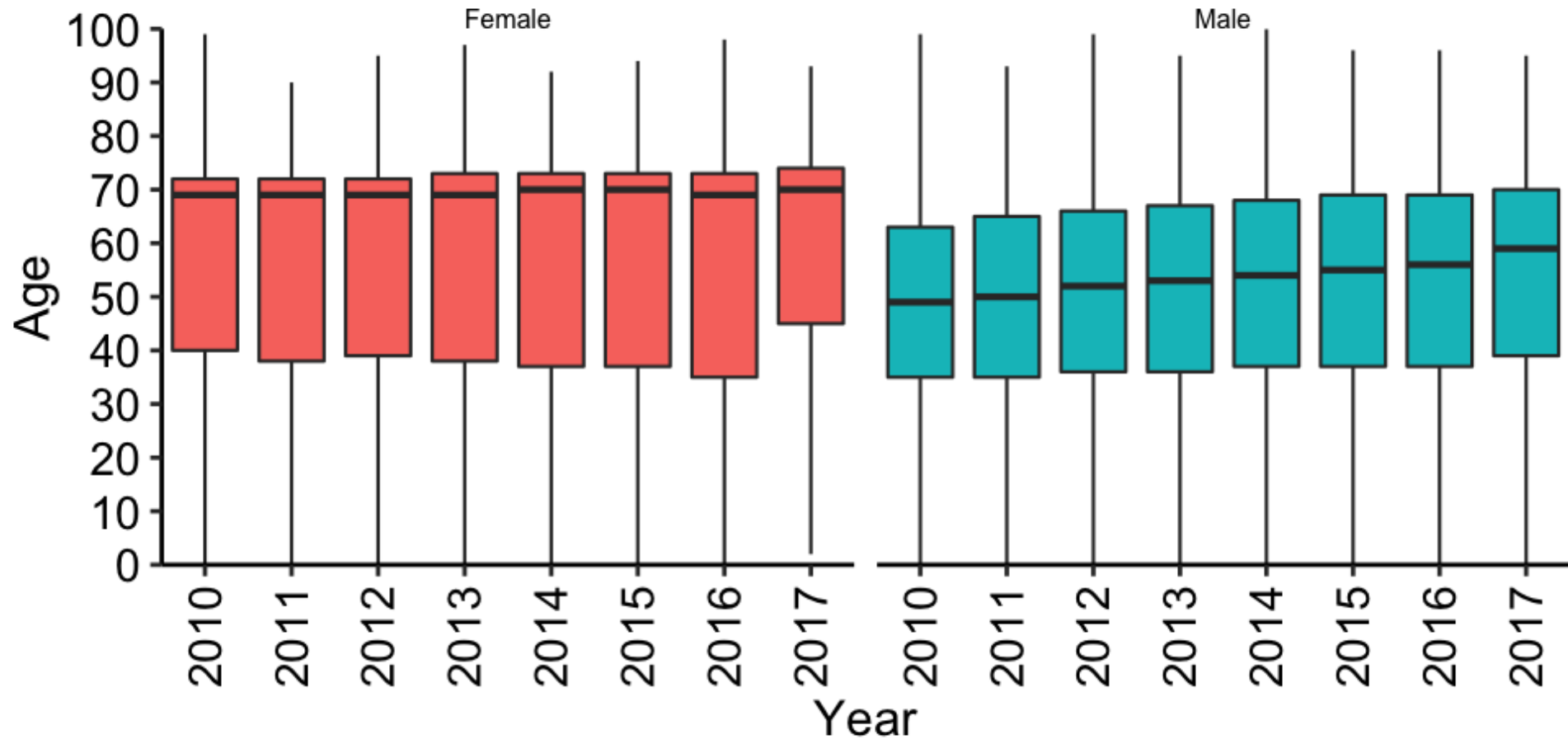

Small Game (Hunt) permits

Small Game permits

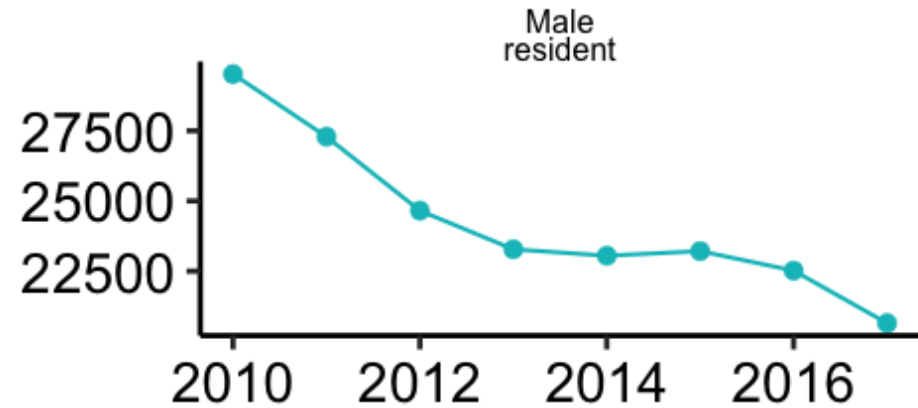
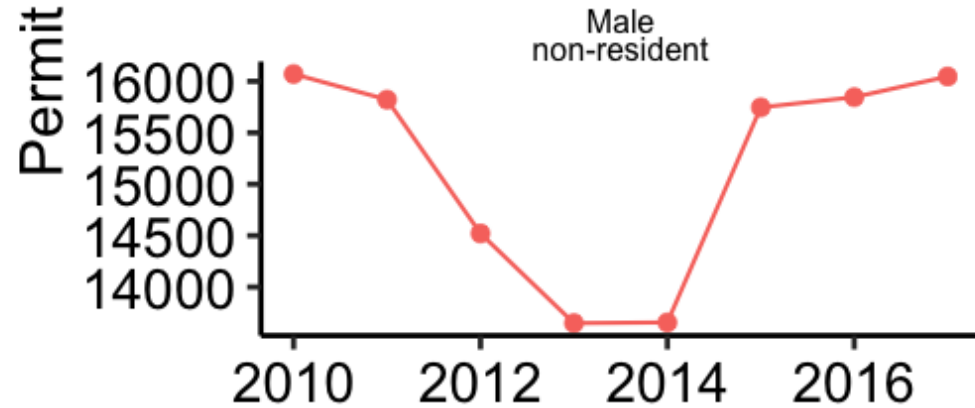
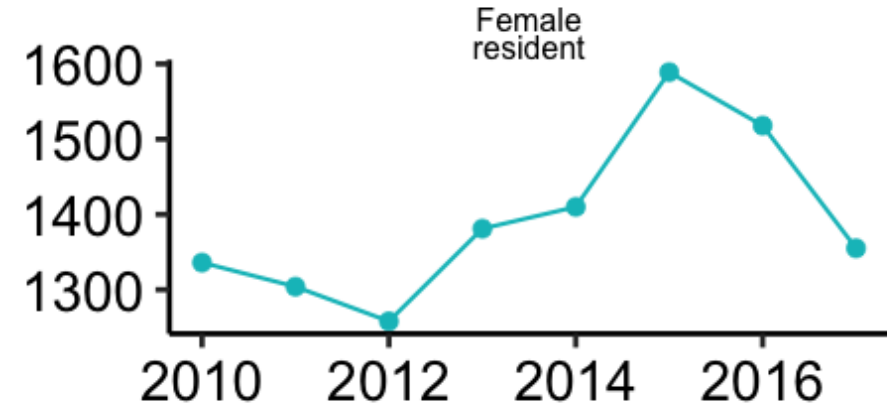
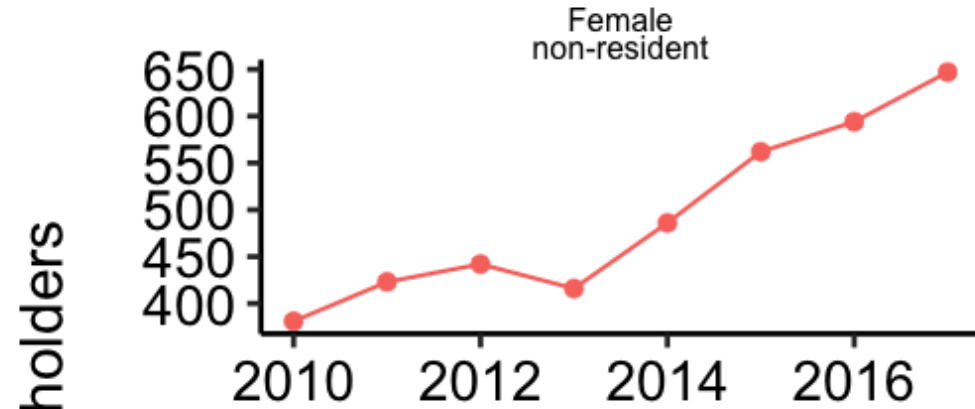

Year

Small Game permits

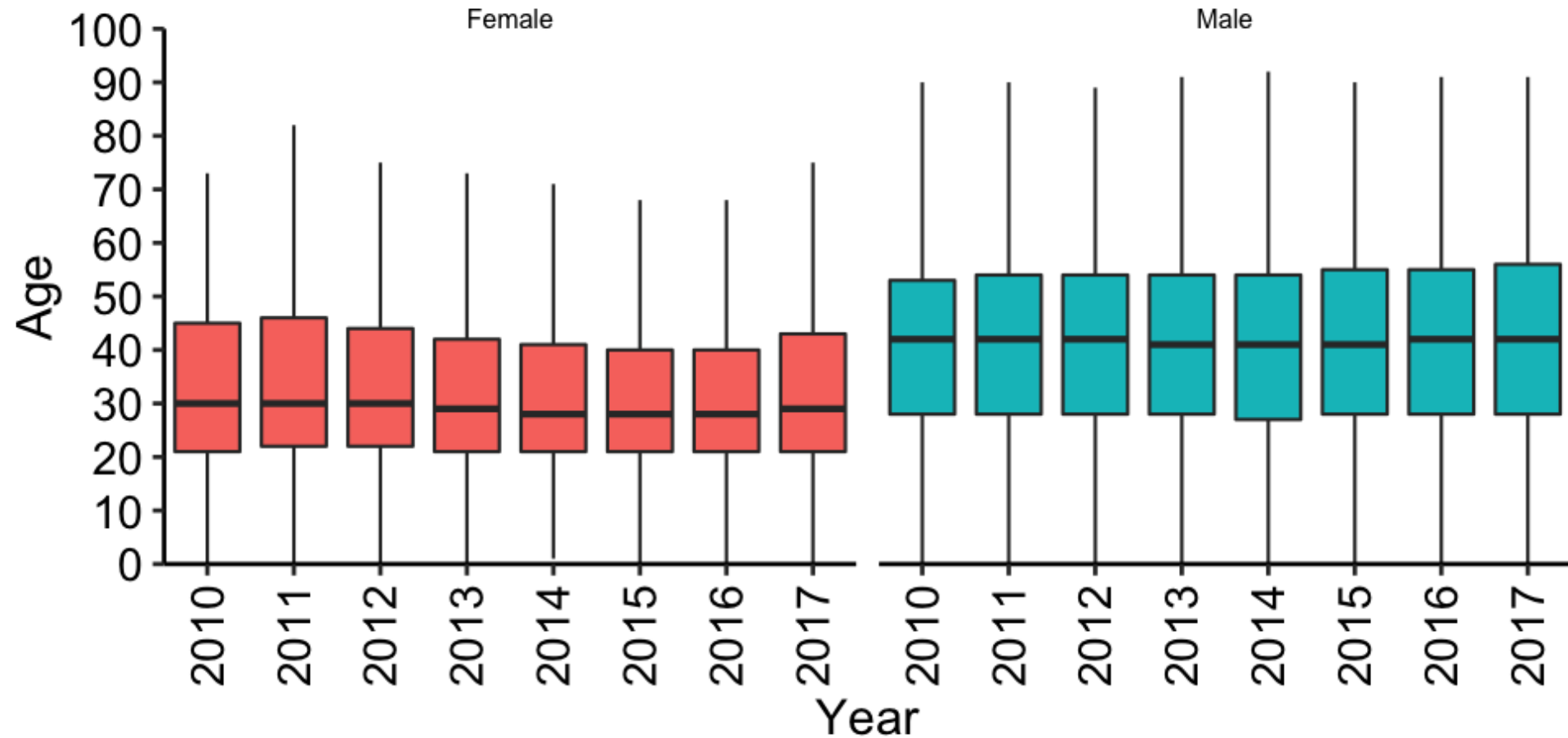

Turkey (spring and fall) permits

Turkey (spring and fall) permits

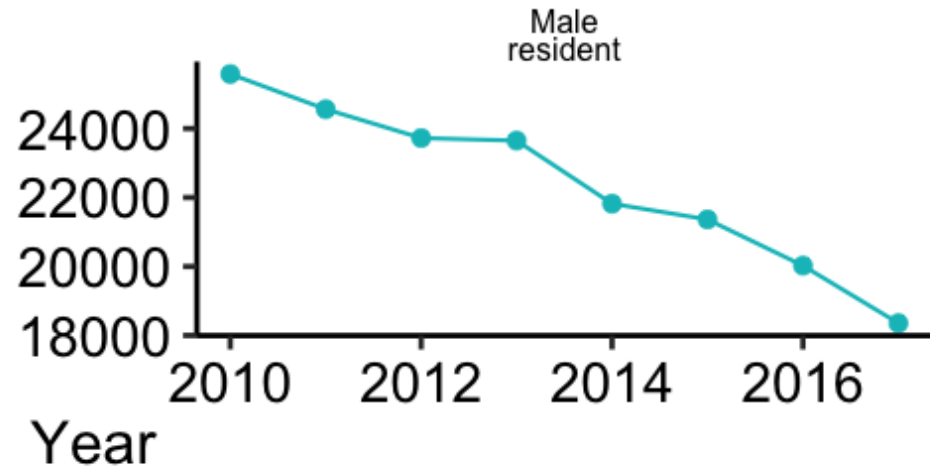
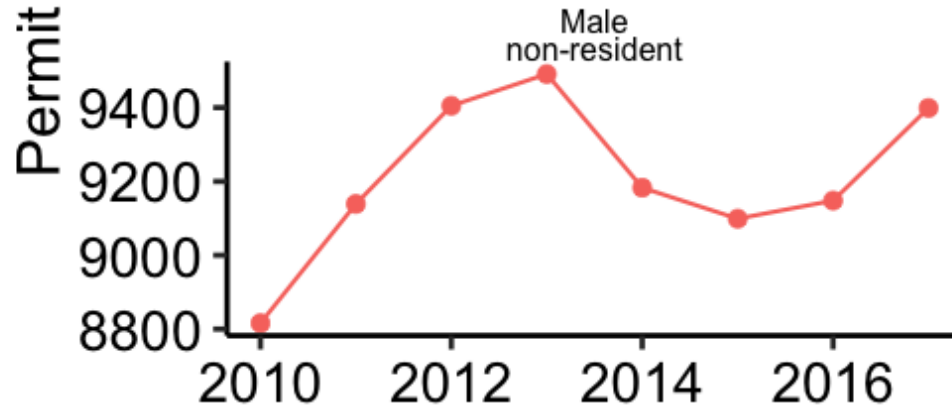
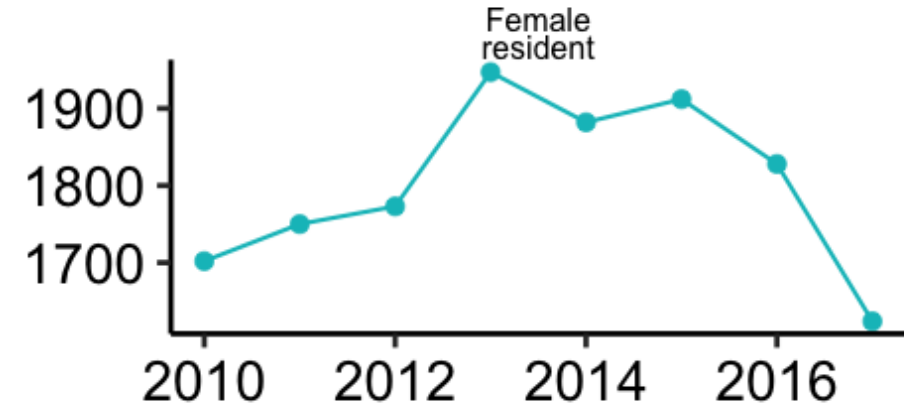
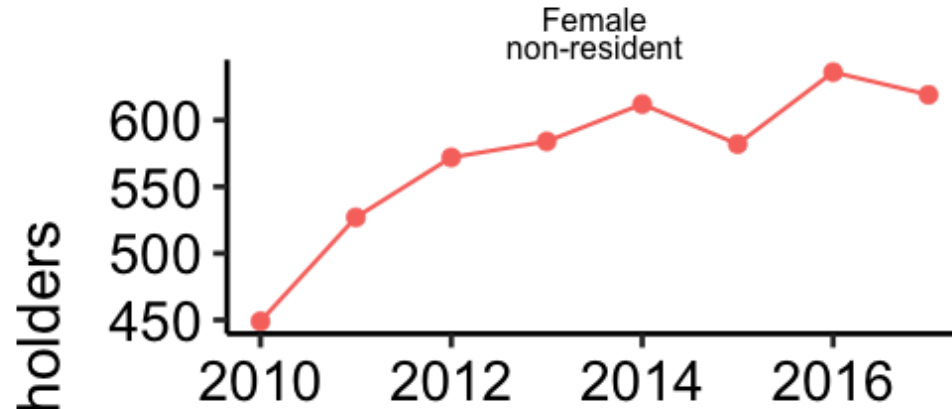

Turkey (spring and fall) permits

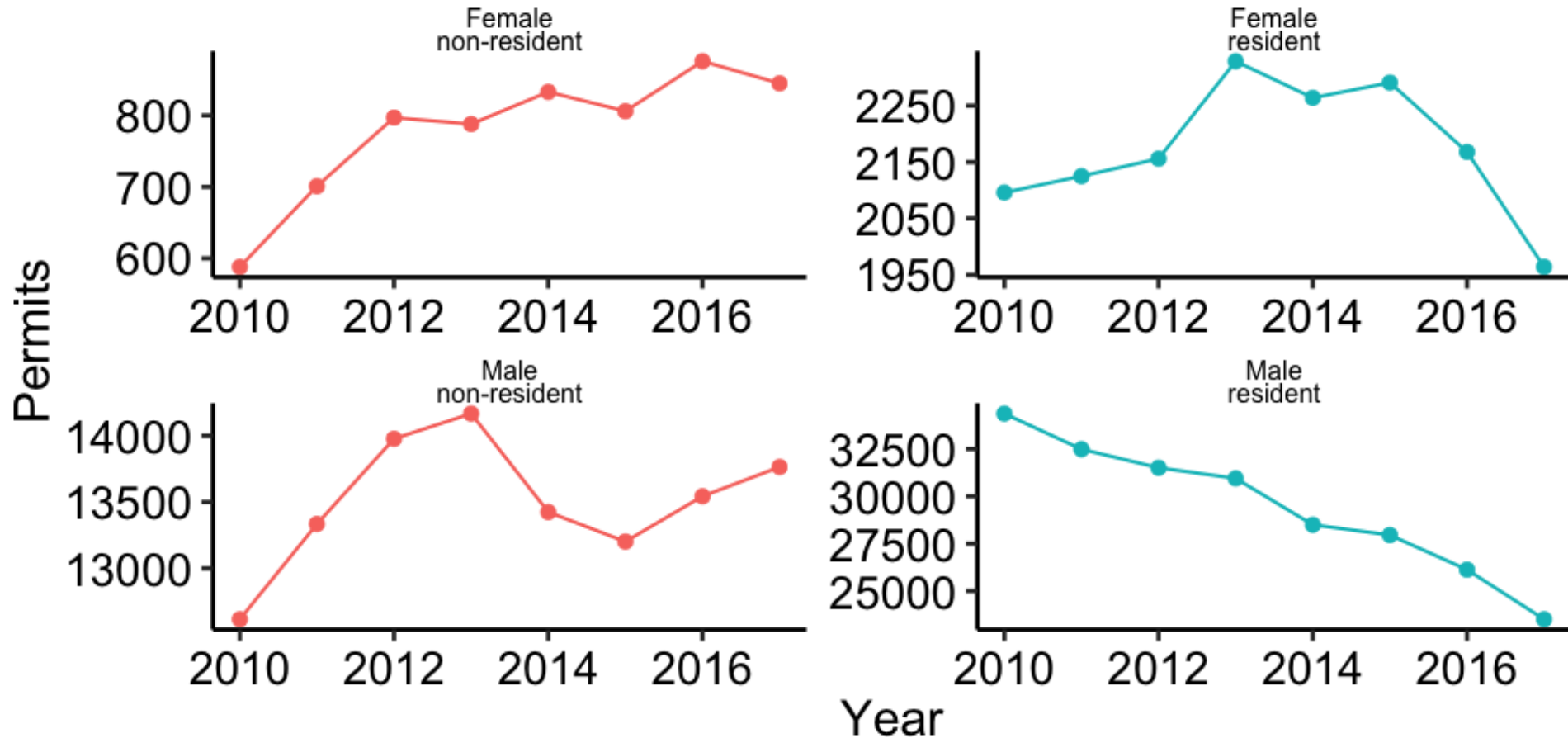

Turkey (spring and fall) permits

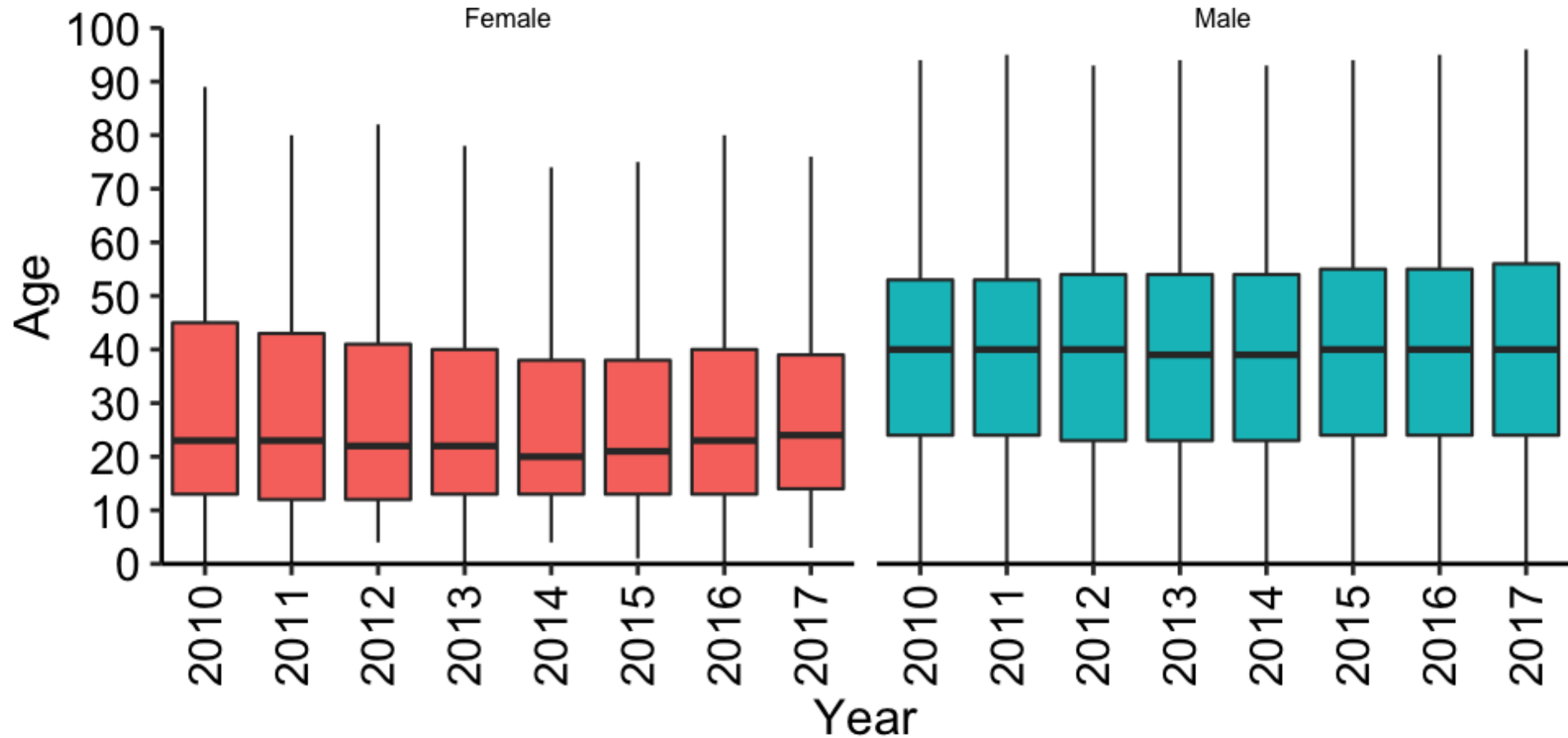

Fur Harvest permits

Fur Harvest permits

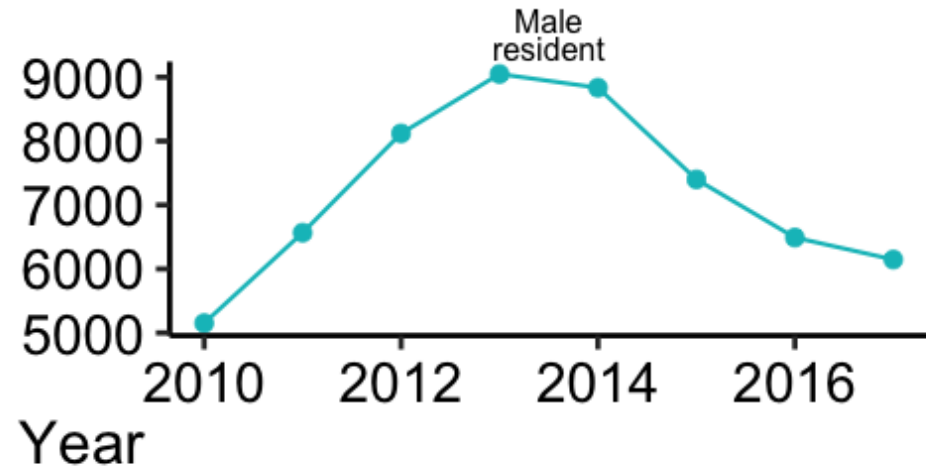
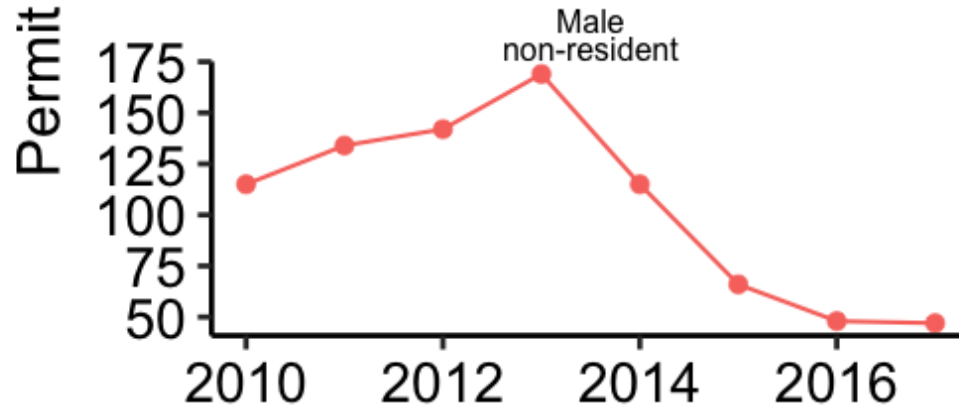
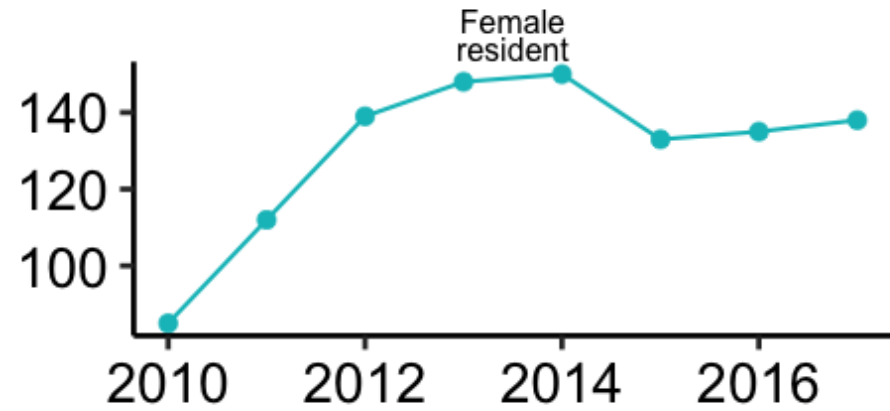
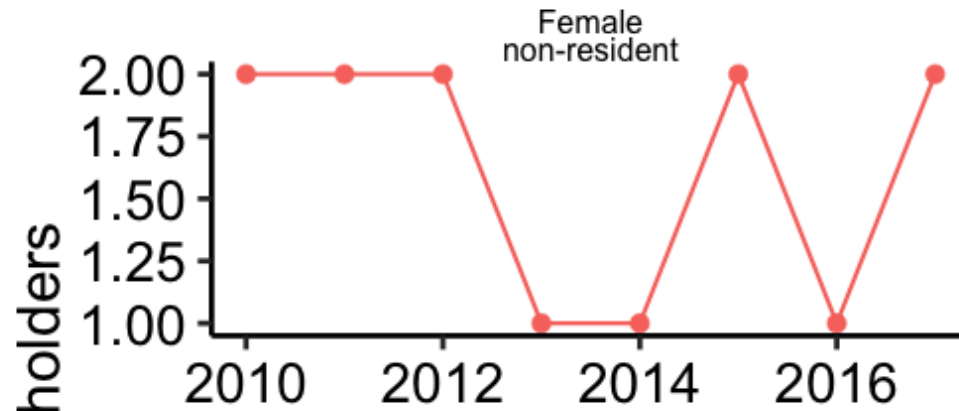

Fur Harvest permits

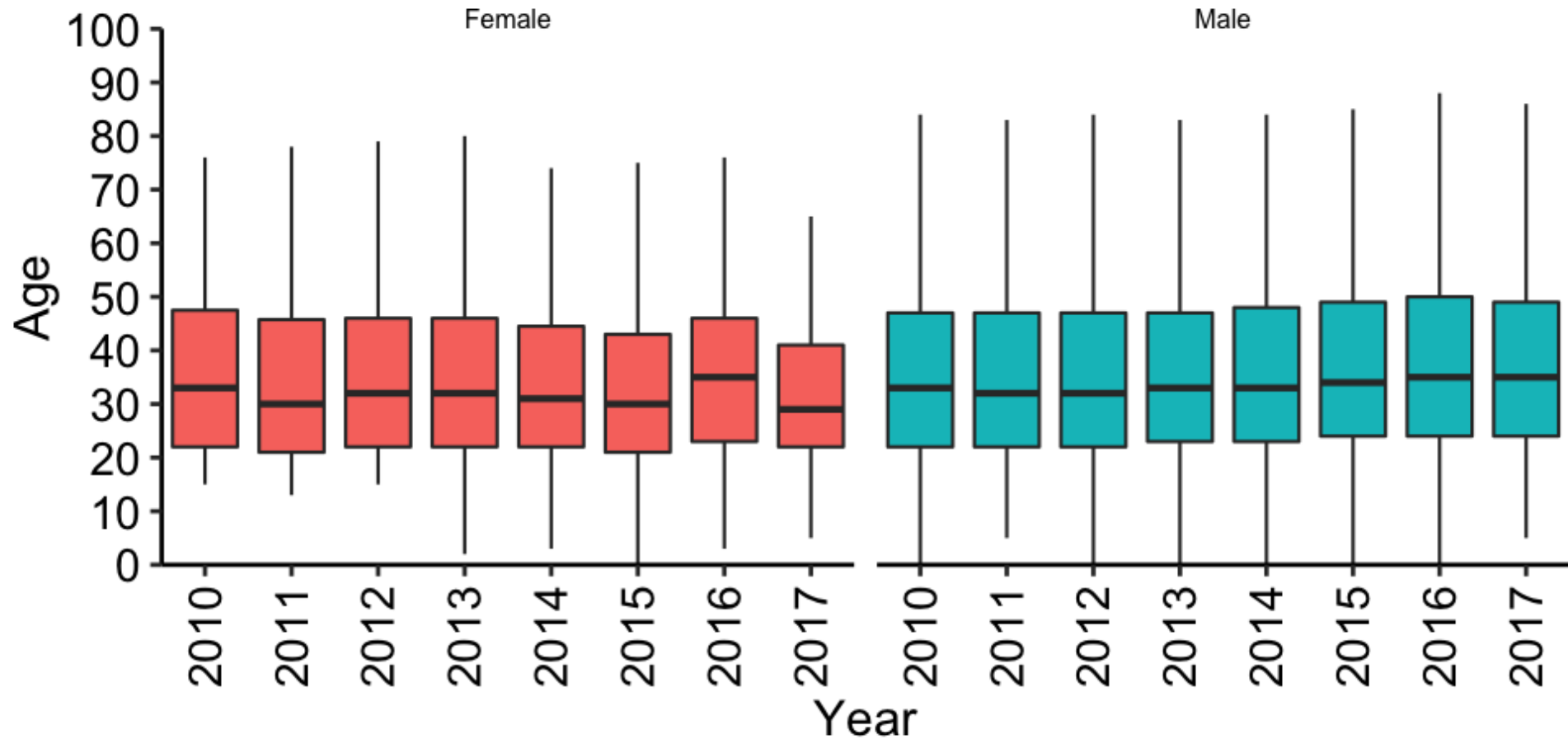

Online Park permits

Online Park permits

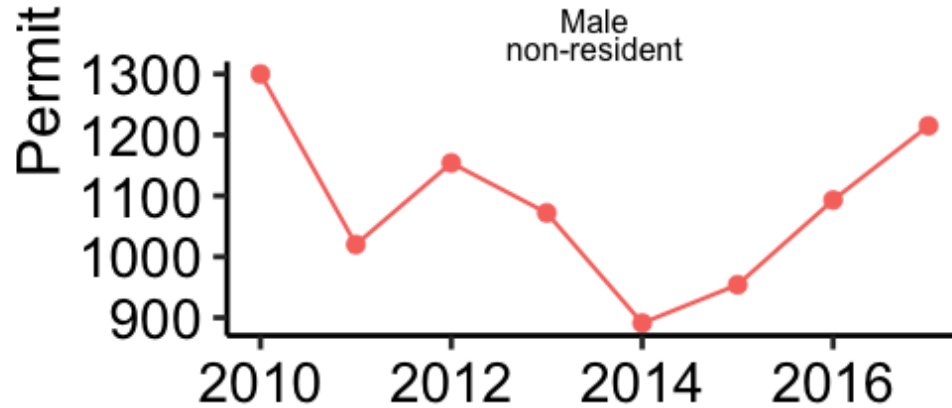
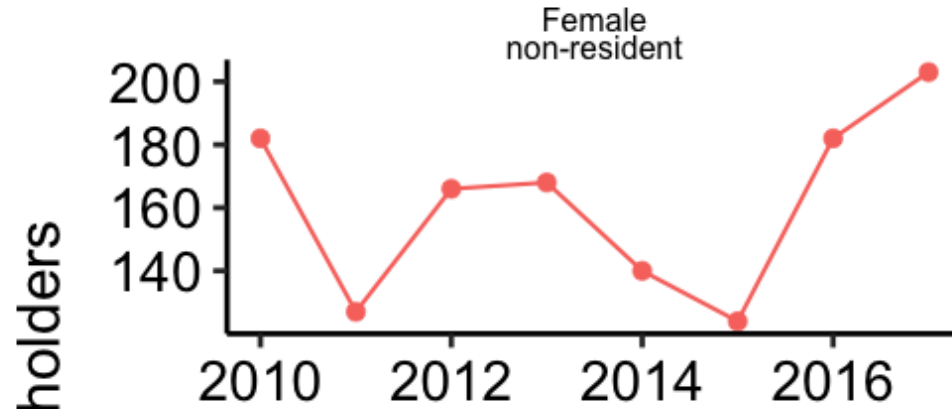

Online Park permits

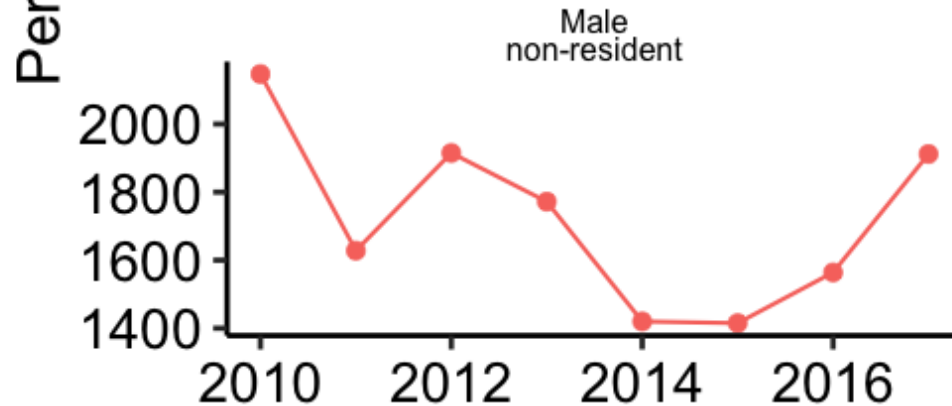
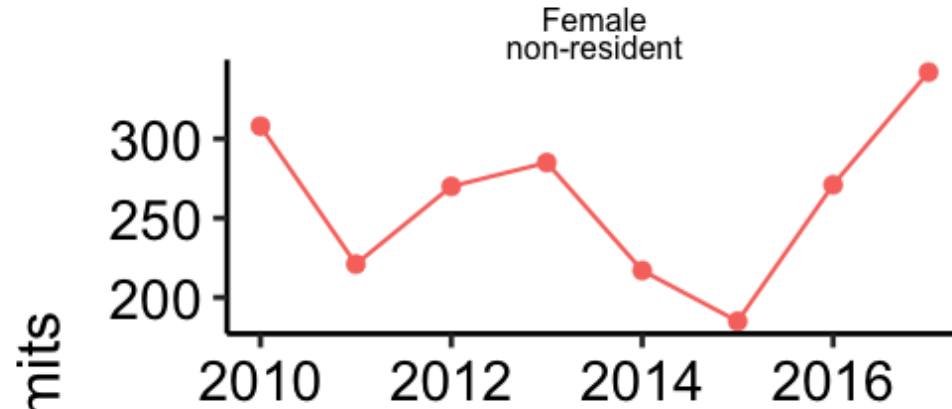

Year

Online Park permits

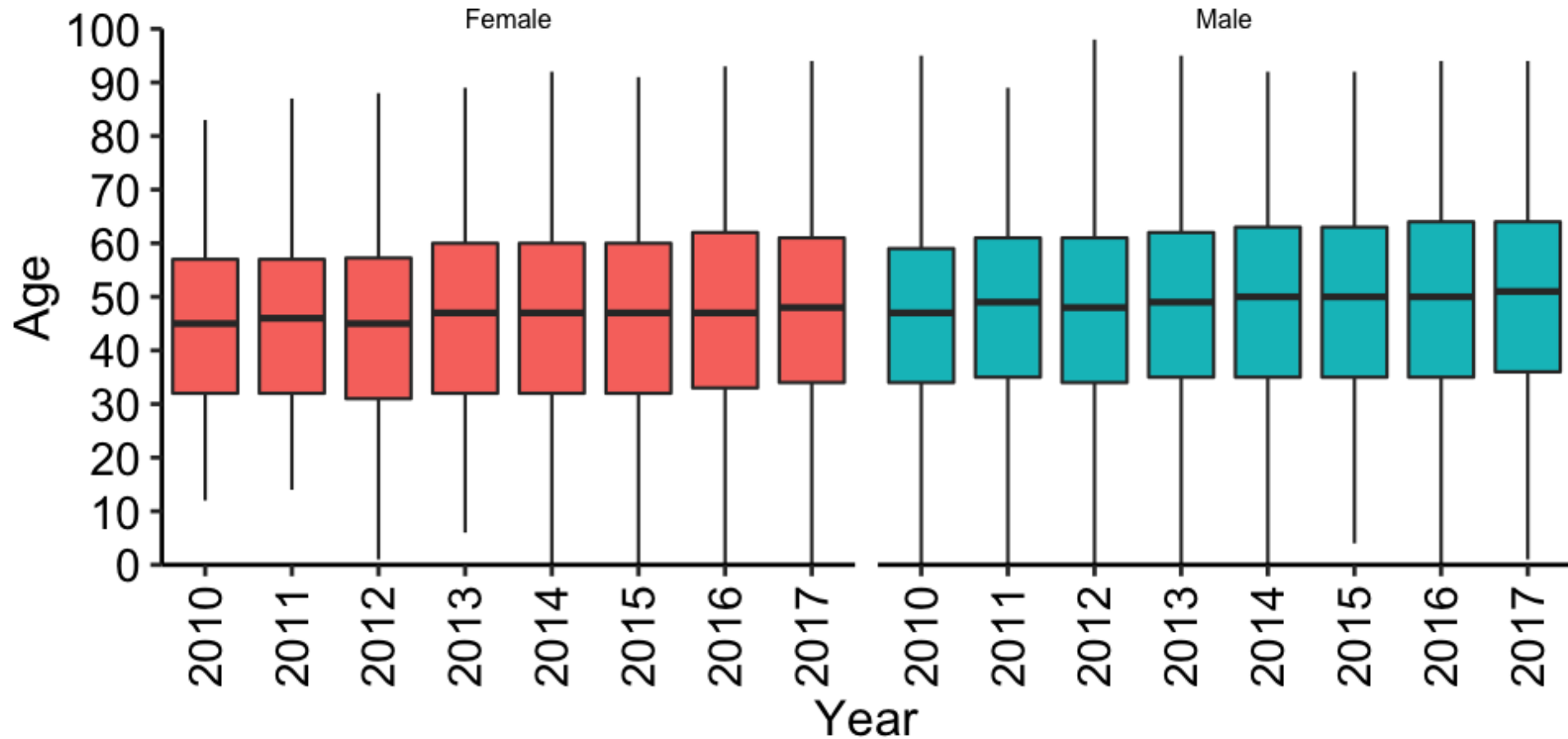

What types of permits are bought together?



Cross buying

Cross-buying (i.e., the purchase of products from multiple categories) has been associated with greater levels of customer retention, revenue generation, and loyalty.

Activity groupings

individuals

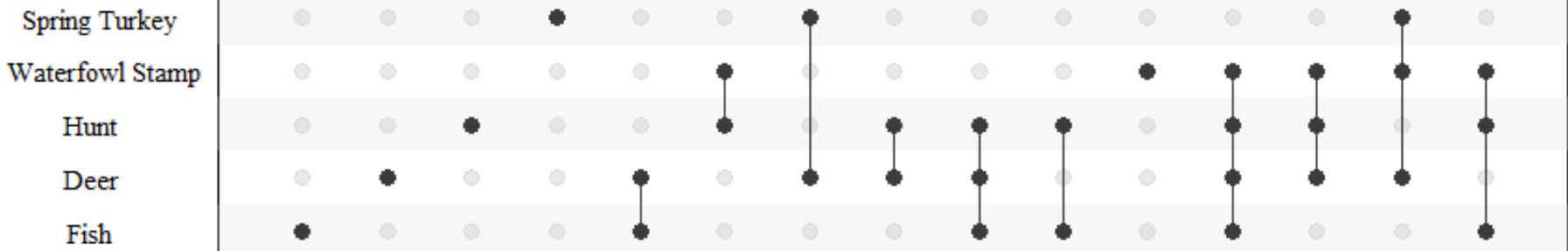
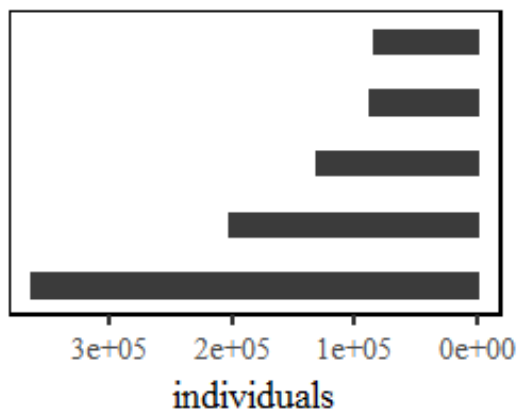
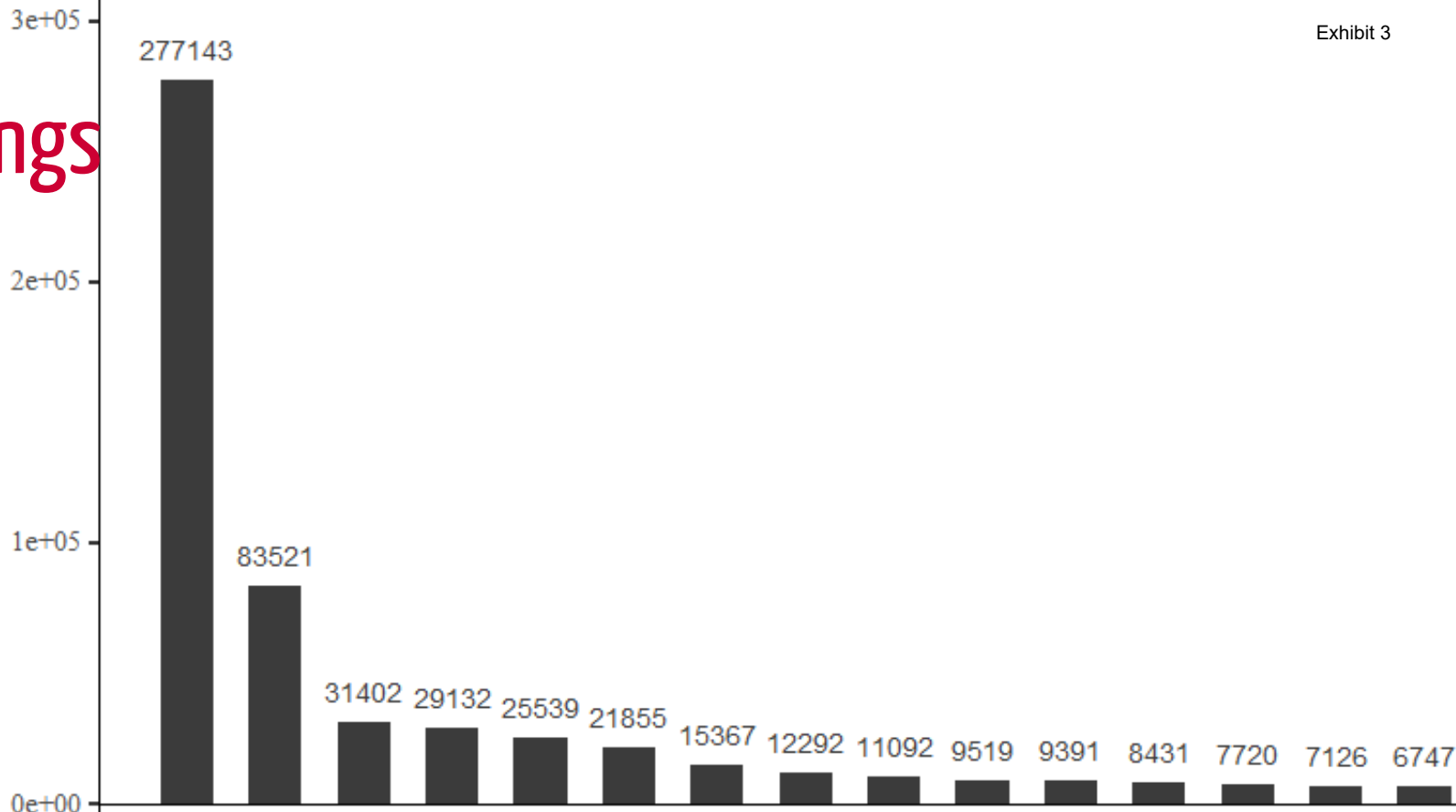

Activity groupings



Methods

Nebraska Game and Parks Commission database

- Residents 16+ years old
- Annual and multi-year permits
- Lifetime & multi-year permits were split as individual permits (e.g., 3-year permit = 3 consecutive annual permits)
- Fish & Small Game combo permits = 1 Fish, 1 Small Game

Female

6862 Z1

Exhibit 3



6862 Z1

Female

Male

Exhibit 3

Probability of having

Spring Turkey

0.11

Small Game

0.31

Fish

0.5

Deer

Deer

Fish

Small Game

Spring Turkey

Deer

Fish

Small Game

Spring Turkey

given this

0.25

0.66

0.69

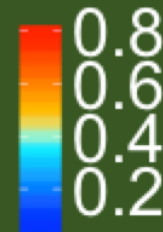

Female

Male

Probability of having

Spring
Turkey

0.11 0.02 0.14

Small
Game

0.31 0.09 0.55

Fish

0.5 0.76 0.69 0.69 0.79 0.81

Deer

0.09 0.46 0.65

Deer

Fish

Small
GameSpring
Turkey

Deer

Fish

Small
GameSpring
Turkey

given this



Take home points

- NE anglers tend to only buy angler permits
- NE turkey hunters are invested
- Females are less likely to have multiple permits

What is the relationship between cross-buying and lapsing?



Deer hunters

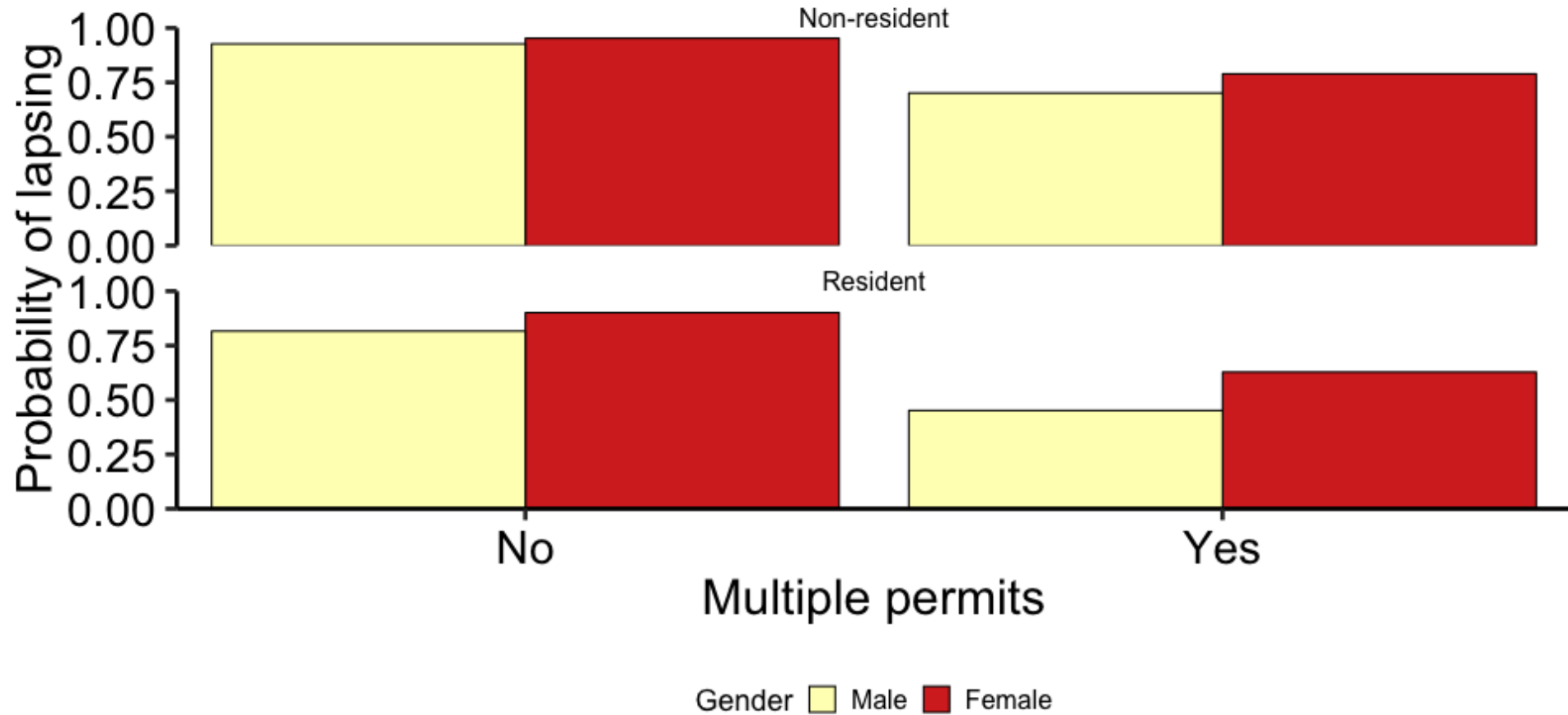

Anglers

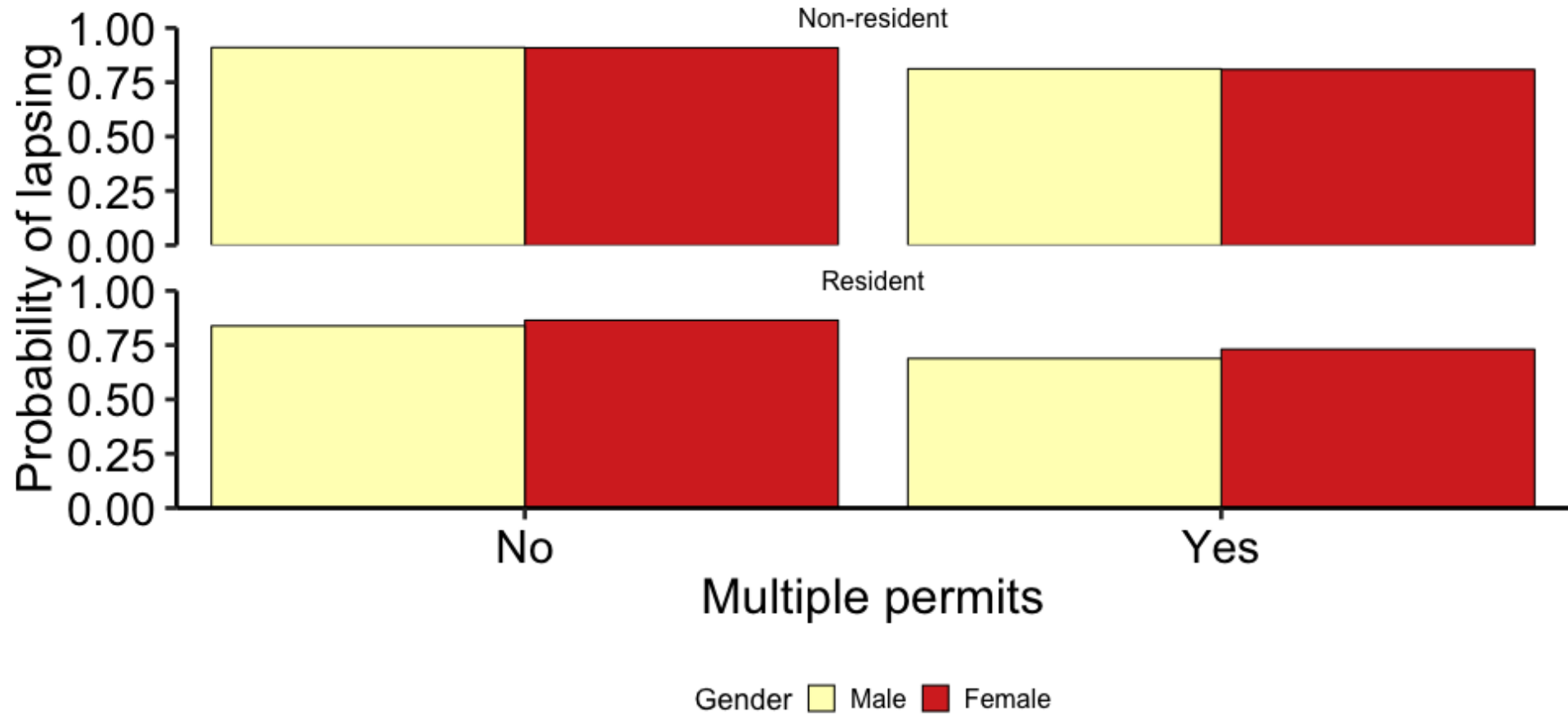

Take home points

- Anglers probability of lapsing is greater
- Non-residents and females more likely to lapse
- Unkown whether cross-buying prevents lapsing or those that dont lapse just buy more permits

How dynamic are permit holders?

Modelling dynamics of sportspersons

- Followed the 2010 cohort of resident permit holders through 2017
 - Focused on **Retention** and **Reactivation**

Modelling dynamics of sportspersons

- Followed the 2010 cohort of resident permit holders through 2017
 - Focused on **Retention** and **Reactivation**
- Broke into 4 main groups: Anglers, Hunters, Angler-Hunters, Inactive
 - Inactive broken into 5 levels (1-yr inactive, 2-yr inactive, ...)

Modelling dynamics of sportspersons

- Followed the 2010 cohort of resident permit holders through 2017
 - Focused on **Retention** and **Reactivation**
- Broke into 4 main groups: Anglers, Hunters, Angler-Hunters, Inactive
 - Inactive broken into 5 levels (1-yr inactive, 2-yr inactive, ...)
- Modeled the probability that a sportsperson would transition between groups

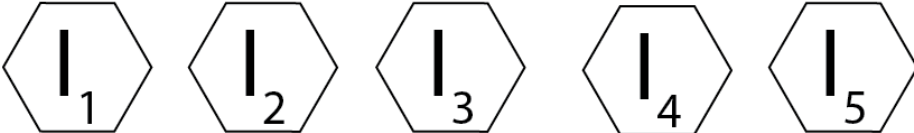

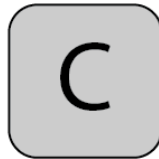
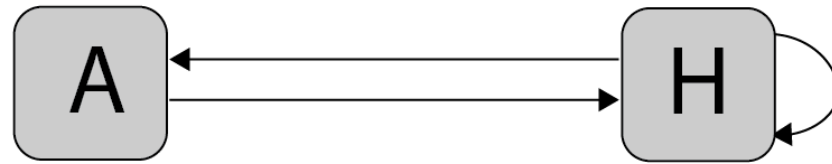

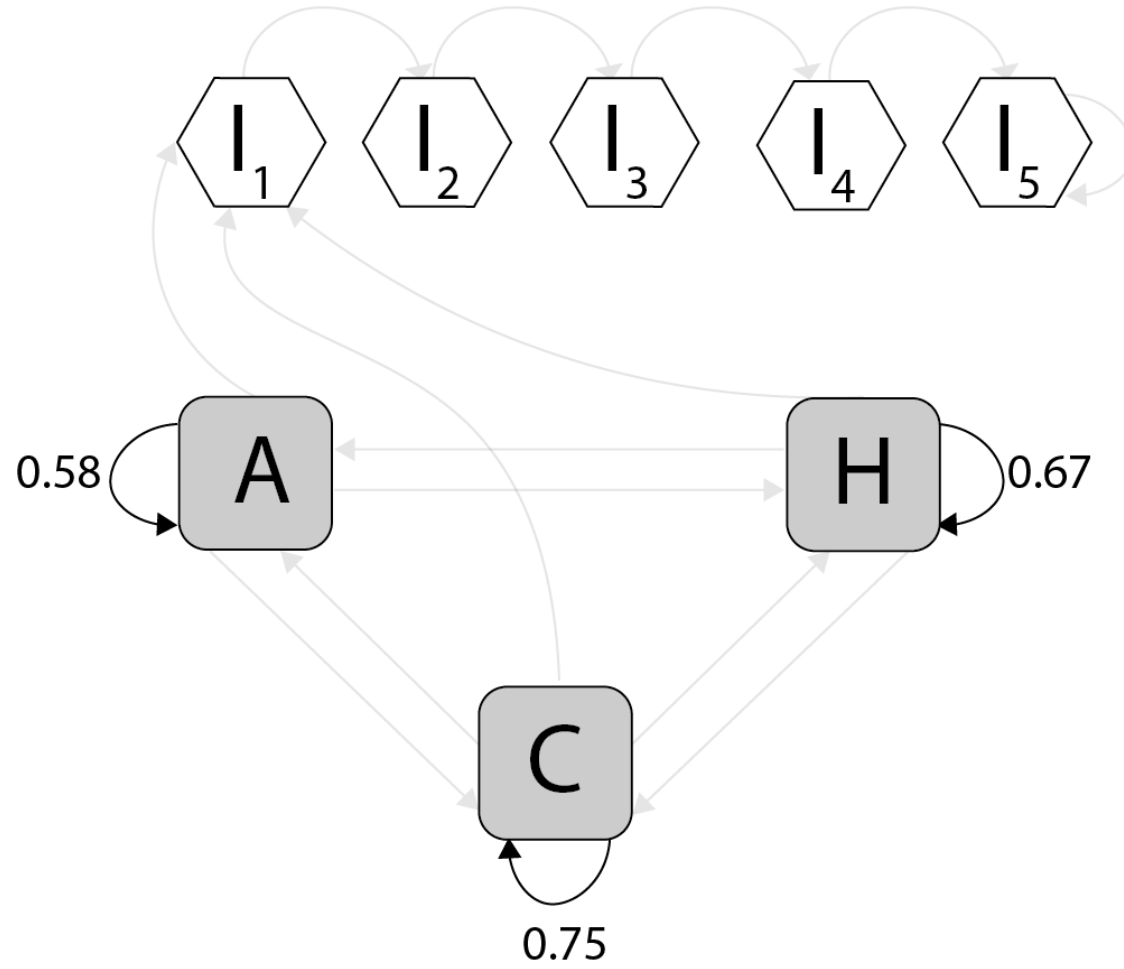

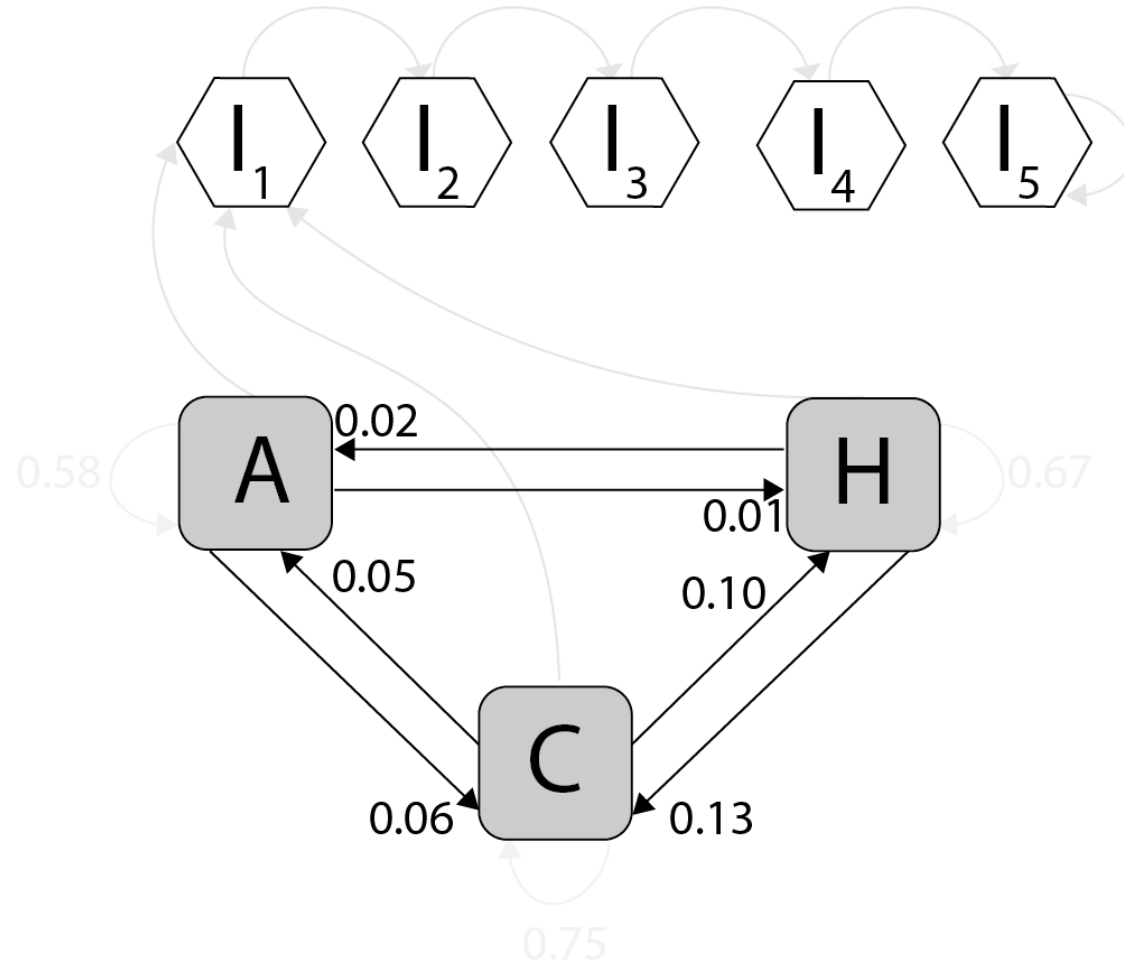

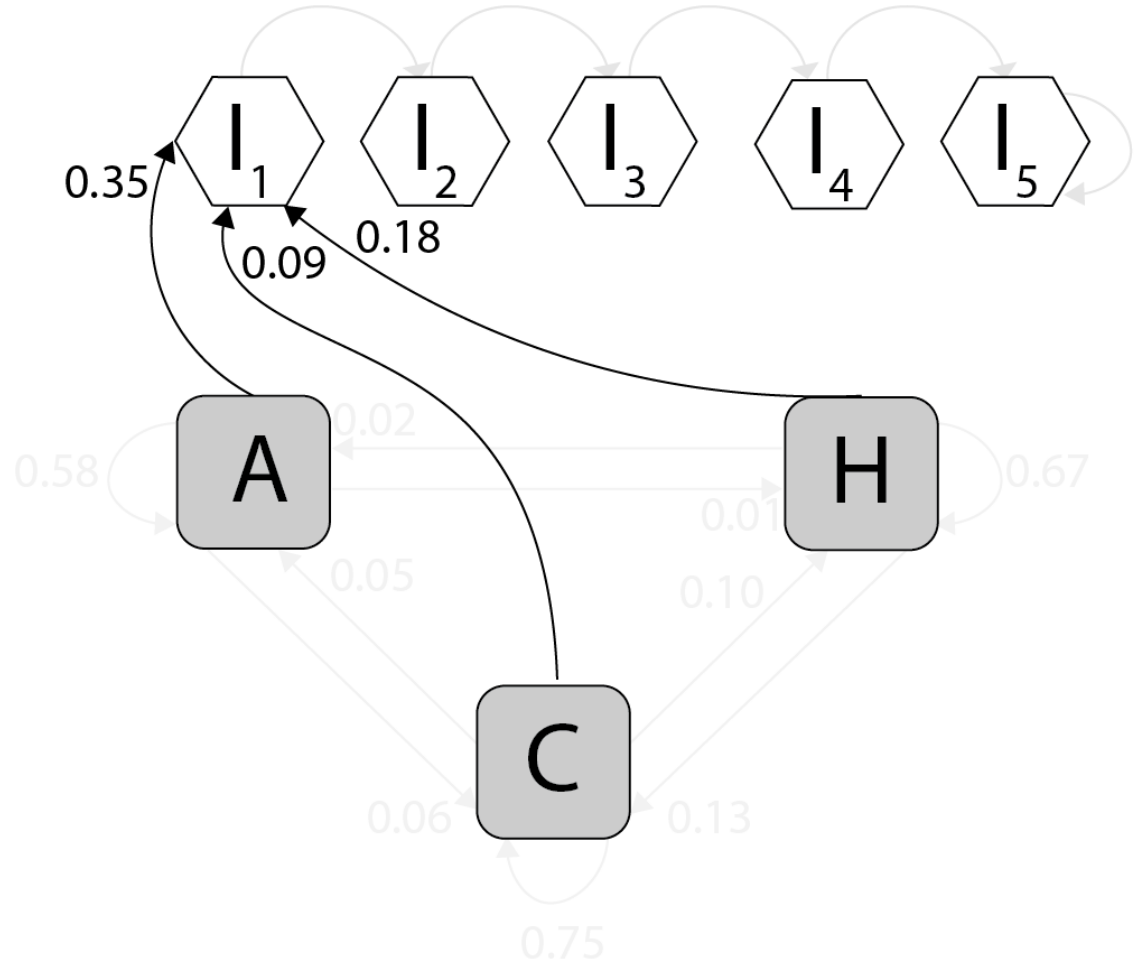

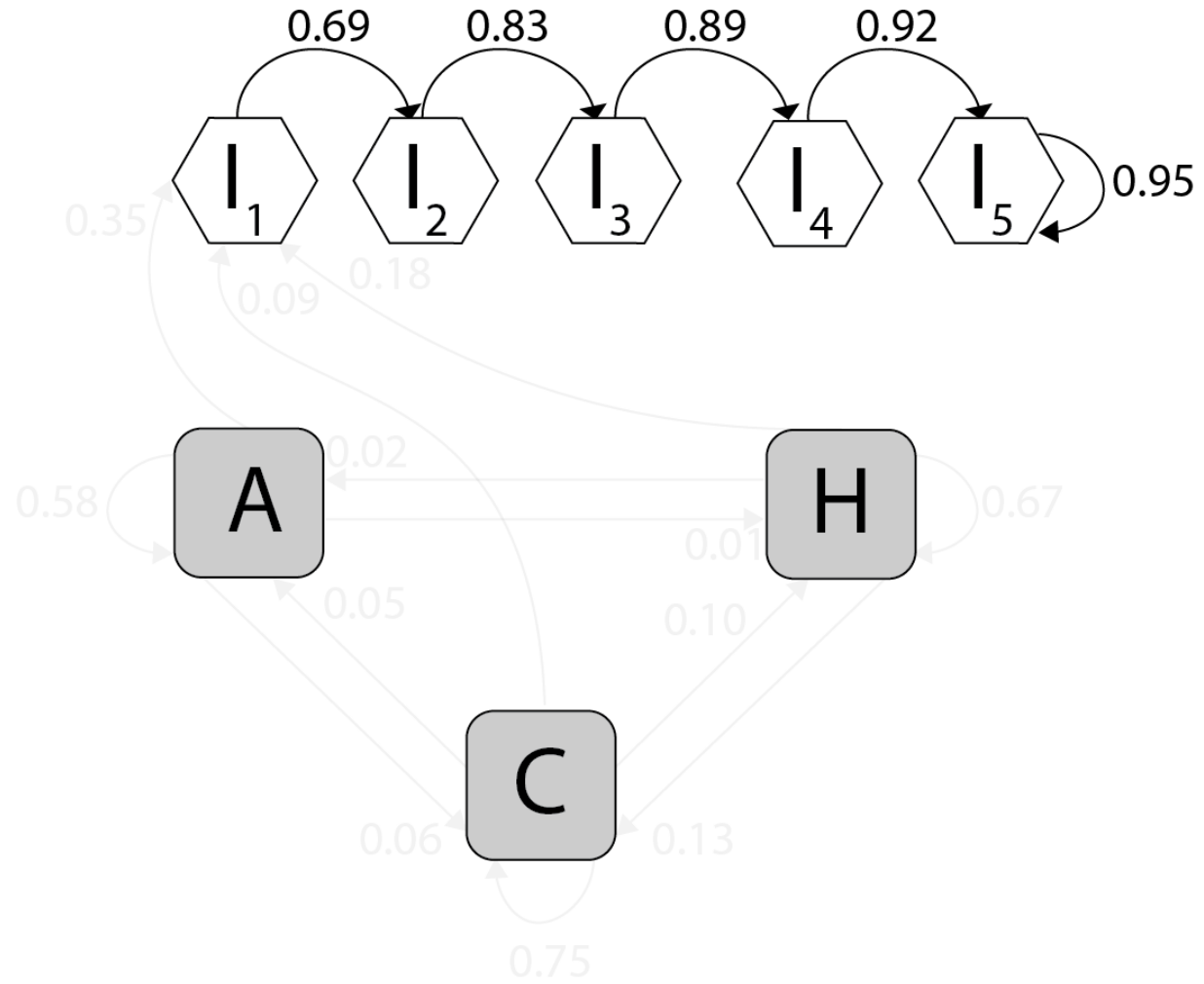

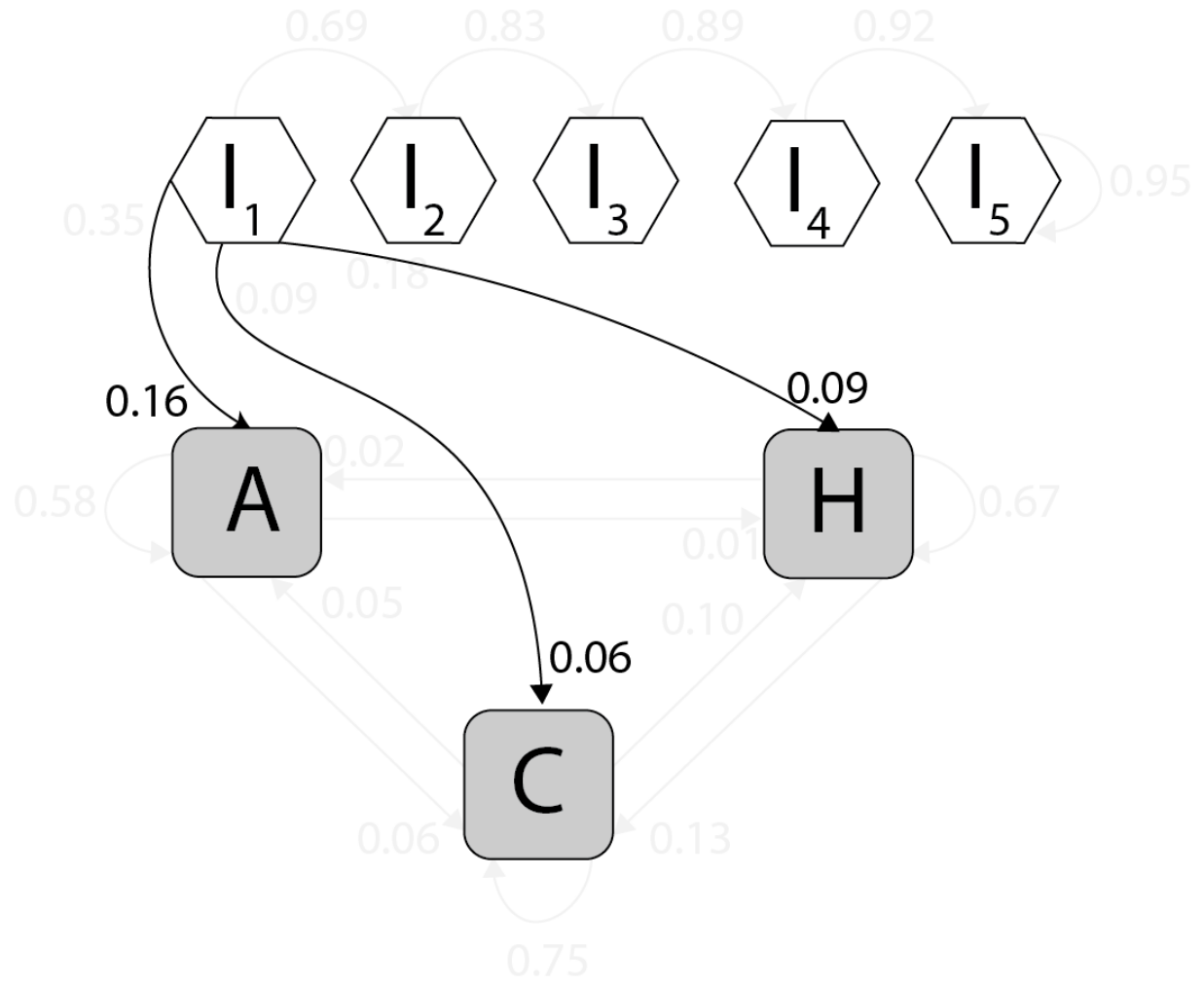

Take home points

- Nebraska has growing angler numbers but decreasing hunter numbers
 - Similar to national trends
- **Retaining** and **Reactivating** sportspersons is important
 - Especially those recently lapsed
- After becoming inactive for a few years, it is unlikely they are returning
- Currently low probability of transitioning between hunting and fishing
- Need to better understand how to R3 efforts influence transition probabilities

What motivates our hunters?

Motivation survey

- In 2015, sent out 7000 survey invitations to random selection of deer, small game, turkey, and combo permit holders
- Species preference questions using best worst choice approach
- Why participate?
 - socializing, enjoying nature, and enjoying solitude
 - Challenge factors (e.g., harvest a trophy, fill bag or tag)
 - Consumption factors (i.e., providing meat for me, family or friends)
- What prevents participation?
 - Costs (4), Access (3), Activity (4), Game populations (2), Regulations (2)

Species Set (1):

	Least Preferred	Most Preferred
Pheasant	<input type="radio"/>	<input type="radio"/>
Waterfowl (Duck, Goose)	<input type="radio"/>	<input type="radio"/>
Deer (Mule, Whitetail)	<input type="radio"/>	<input type="radio"/>
Quail	<input type="radio"/>	<input type="radio"/>

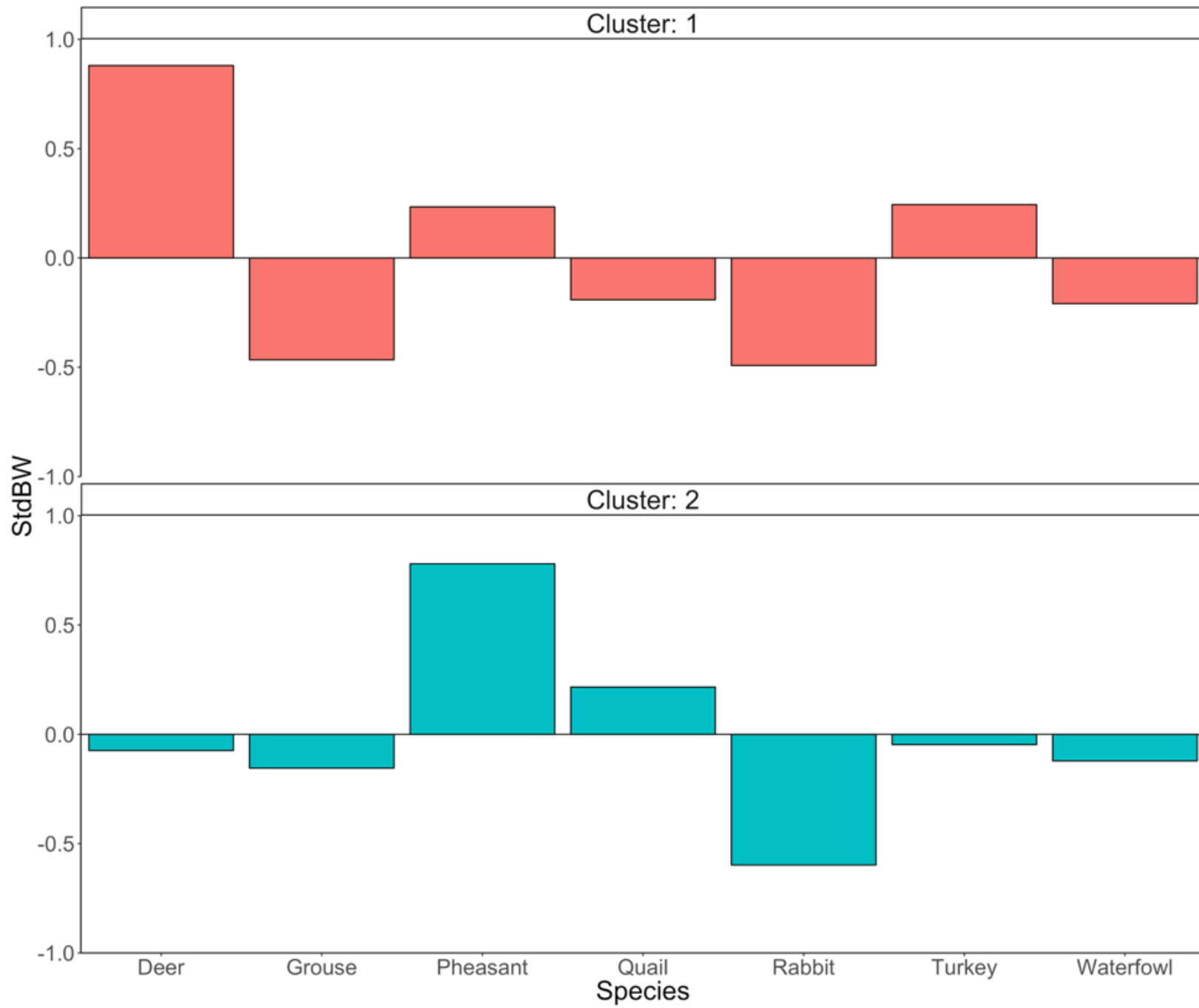

Factor	Upland game preference	Big game Preference	P	Effect size
Setting motivation				
Spending time outdoors/experiencing nature	4.58 (0.65)	4.55 (0.70)	0.555	
Social motivation				
Spending time with family or friends	4.38 (0.86)	4.32 (0.97)	0.379	

Factor	Upland game preference	Big game Preference	P	Effect size
Hunt motivations				
Harvesting a trophy animal	1.99 (1.20)	2.68 (1.30)	<0.001	-0.542
Obtaining my bag limit/filling my tag	2.34 (1.13)	2.57 (1.22)	0.006	-0.192
Providing meat for myself, family, or friends	2.74 (1.30)	3.65 (1.22)	<0.001	-0.731
Managing game populations	3.13 (1.25)	3.62 (1.14)	<0.001	-0.416
Enjoying solitude	3.79 (1.14)	4.06 (1.02)	0.001	-0.253
Hunting for the challenge	3.61 (1.14)	3.94 (1.03)	<0.001	-0.319

Factor	Upland game preference	Big game Preference	P	Effect size
Hunt motivations				
Opportunity to get a shot at an animal	2.99 (1.28)	3.03 (1.25)	0.714	
Outwitting difficult-to-hunt species	3.23 (1.30)	3.47 (1.28)	0.013	-0.183
Observing game species	3.86 (1.08)	4.06 (0.94)	0.013	-0.196

Barriers

Factor	Upland game preference	Deer preference	P	Effect size
Cost	1.86 (1.11)	2.13 (1.17)	<0.001	0.243
Access	3.17 (1.49)	3.05 (1.50)	0.058	
Activity	1.67 (0.94)	1.59 (0.90)	0.029	-0.080
Game populations	3.15 (1.37)	2.49 (1.20)	<0.001	-0.487
Regulations	1.90 (1.16)	2.05 (1.17)	0.029	0.113

Dashboard

HuntFishApp

NEBRASKA



HUNTER & ANGLER RESEARCH



cchizinski2@unl.edu



FishHunt.unl.edu



402-472-8123