

* ORIGINAL *

State of Nebraska - INVITATION TO BID CONTRACT

Return to:
State Purchasing Bureau
1526 K Street, Suite 130
Lincoln, Nebraska 68508

Telephone: 402-471-6500
Fax: 402-471-2089

Date	5/16/19	Page	1 of 2
Solicitation Number	6093 OF		
Opening Date and Time	06/18/19	2:00 pm	
Buyer	RENE BOTTS (AS)		

DESTINATION OF GOODS
MULTIPLE DELIVERY LOCATIONS
PLEASE REFER TO DOCUMENTATION
FOR DELIVERY ADDRESSES.

Per Nebraska's Transparency in Government Procurement Act, DAS is required to collect statistical information regarding the number of contracts awarded to Nebraska contractors. This information is for statistical purposes only and will not be considered for contract award purposes.

____ NEBRASKA CONTRACTOR AFFIDAVIT: Bidder hereby attests that bidder is a Nebraska Contractor. " Nebraska Contractor" shall mean any bidder who has maintained a bona fide place of business and at least one employee within this state for at least the six (6) months immediately preceding the posting date of this ITB.

____ I hereby certify that I am a Resident disabled veteran or business located in a designated enterprise zone in accordance with Neb. Rev. Stat. §73-107 and wish to have preference, if applicable, considered in the award of this contract.

Contract to supply and deliver TRUCK MOUNTED SEQUENTIAL FLASHING ARROW BOARD to the State of Nebraska as per the attached specifications for a one (1) year period from date of award. The contract may be renewed for four (4) additional one (1) year periods when mutually agreeable to the vendor and the State of Nebraska.

(vc 5/15/19)

* ORIGINAL *

INVITATION

Line	Description	Quantity	Unit of Measure	Unit Price	Extended Price
1	TRUCK MOUNTED SEQUENTIAL FLASHING ARROW BOARD 48X96"	10.0000	EA	\$4,267.97	\$42,679.70
	MAKE <u>K & K SYSTEMS, INC.</u>				
	MODEL <u>AV254896</u>				
	OPTIONS:				
2	30 X 60" ARROW BOARD	10.0000	EA	\$3,834.40	\$38,344.00

BIDDER MUST COMPLETE THE FOLLOWING

DISCOUNT PAYMENT TERMS: 1 % 10 DAYS

By signing this Invitation to Bid form, the bidder guarantees compliance with the provisions stated in this Invitation to Bid, agrees to the terms and conditions unless otherwise agreed to (see Section III) and certifies that bidder maintains a drug free work place environment. Vendor will furnish the items requested within 30-45 days after receipt of order. Failure to enter Delivery Date may cause quotation to be REJECTED.

Sign Here Alice K. Bingham
(Authorized Signature MANDATORY - MUST BE SIGNED IN INK)

Enter Contact Information Below

VENDOR# _____
VENDOR: K & K SYSTEMS, INC.
Address: 687 PALMETTO ROAD
TUPELO, MS 38801

Contact ALICE K. BINGHAM
Telephone 888-414-3003 OR 662-566-2025
Facsimile 662-566-7123
Email ali@k-ksystems.com

State of Nebraska - INVITATION TO BID CONTRACT

Return to:
State Purchasing Bureau
1526 K Street, Suite 130
Lincoln, Nebraska 68508

Telephone: 402-471-6500
Fax: 402-471-2089

Date	5/16/19	Page	2 of 2
Solicitation Number	6093 OF		
Opening Date and Time	06/18/19	2:00 pm	
Buyer	RENE BOTTS (AS)		

DESTINATION OF GOODS
MULTIPLE DELIVERY LOCATIONS
PLEASE REFER TO DOCUMENTATION
FOR DELIVERY ADDRESSES.

INVITATION

Line	Description	Quantity	Unit of Measure	Unit Price	Extended Price
	MAKE <u>K & K SYSTEMS, INC.</u>				
	MODEL <u>AS2000-RFKIT, M-LP-A, M-90-A</u>				
3	WIRELESS REMOTE	10.0000	EA	\$284.76	\$2,847.60
4	POWER TILT	10.0000	EA	\$804.16	\$8,041.60
				\$622.02	\$6,220.20

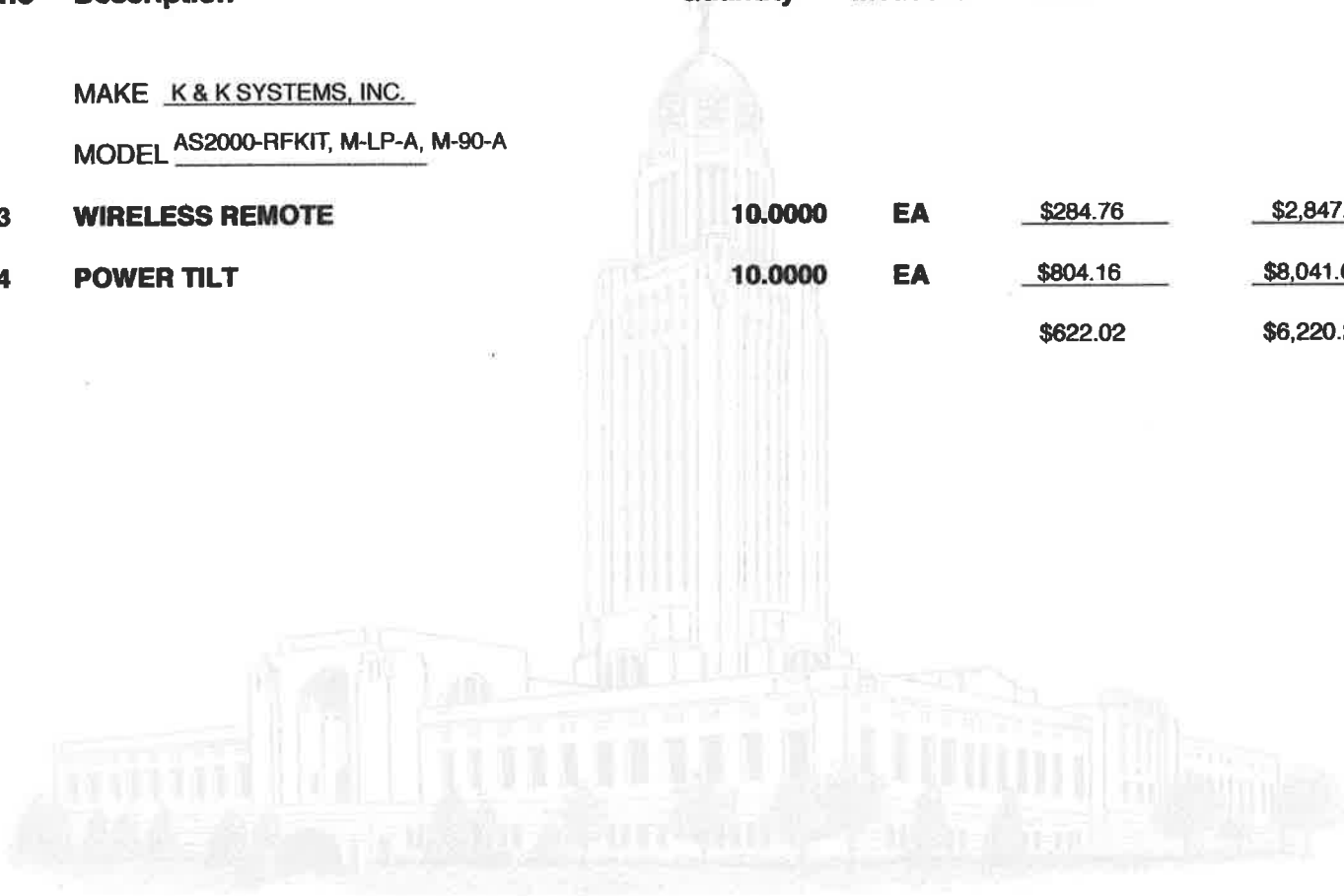

K&K Systems

Systems

QUOTATION

687 Palmetto Road
Tupelo, MS 38801
www.k-ksystems.com

email: ali@k-ksystems.com
Phone: 662-566-2025
Fax: 662-566-7123 TollFree: 888-414-3003

Quotation #: **Q190618AB-1-NE-STATEOFNEBRASKA**
Quotation Date: **6/18/2019**
Customer Type: **Your Cost**

Customer Contact: **RENE BOTTS**
Quote Valid: **45 days**
Prepared by: **Ali Bingham**

Bill To:	Ship To:
Name: Rene Botts Company Name: State of Nebraska Street Address: State Purchasing Bureau Address 2: 1526 K Street, Suite 130 City, ST ZIP Code: Lincoln, NE 68506 Tel: 402-471-6500 Cell: Fax: 402-471-2089 email:	(Update if different than Bill To address) Name: Rene Botts Company Name: State of Nebraska Street Address: State Purchasing Bureau Address 2: 1526 K Street, Suite 130 City, ST ZIP Code: Lincoln, NE 68506 Tel: 402-471-6500 Cell: Fax: 402-471-2089 email:

Product

Model #	Description	Base Price
AV254896	Vehicle Mount 25 Lamp par 46 (LED) Arrow Board. Sign dimensions are 48" x 96" all aluminum fabrication with black powder coat finish to give smooth look. Also comes with 360 degree visors, and built-in controller.	\$4,267.97

Packaging

K&K Delivers

Options and Accessories - PER UNIT

QTY per Unit	Item #	Description	Price Each	Price per Unit
1	AS2000-WKIT	Wired handheld controller for AS2000 only. Includes 15' Ethernet Cable (RJ45C15)	INCLUDED	INCLUDED
1	AVSM	Skid Mount Frame.	INCLUDED	INCLUDED
1	ADDPP	Add power pack to include two (2) 10 watt solar panels, one (1) 18 amp battery, additional wiring, mounting hardware and access door.	INCLUDED	INCLUDED
1	ADD10W-KIT	Replace 10 watt top solar panel with 20 watt solar panel for a total 30 watt system. Includes wiring, mounting brackets and bolts.	INCLUDED	INCLUDED
1	RJ45C40	40' Cat 5E Molded Snagless Patch Cable Black - Professional Series - 50 Micron gold Plated RJ45 Connectors	INCLUDED	INCLUDED
1	BCH-1212-KIT	12 amp battery charger with protective plug cover and mounting hardware.	INCLUDED	INCLUDED
1	DDB	Drop-down box for controller. (Controller not included) Mounting hardware included.	INCLUDED	INCLUDED

Special Notes

Terms of Purchase

FOB: Tupelo, MS 38801
Delivery (weeks): 4-6 Weeks
Warranty: 1 year limited warranty, Factory Depot

Per System Total: **\$4,267.97**
Total QTY of Systems: 10 \$42,679.70
Total Shipping Costs: **INCLUDED**
Taxes: 7.00%
GRAND TOTAL: \$42,679.70

Sales Person Signature:

Work Order#

Sales Manager Signature: Timothy Keith

Client PO#

Please note: The above specifications and quotation does not include shipping, permits, or taxes unless otherwise stated. The freight charge is an approximate estimate for your reference; the actual charge may vary. There will be an additional 3% charge on all credit card orders unless otherwise stated. *Lead-time committed is based on the date Purchase Order is received by K&K Systems and deposit made and/or credit approved. Lead time is not based on the date quoted.

Vehicle Mount Arrow Board Model # AV254896

Features

- ▶ Arrow Board Meets MUTCD
- ▶ Photocell for Auto Dimming
- ▶ Super Bright LED Technology
- ▶ Easy to Operate & Maintain Arrow Board
- ▶ Powder Coat Paint
- ▶ 360 Degree LED visors
- ▶ 7 or 12 Function Control Arrow Board
- ▶ 30-40 Flash Rate
- ▶ Numerous Size and Mounting Options
- ▶ Durable Finish Resist the Elements
- ▶ Lightweight Arrow Board
- ▶ Designed to be mounted on large vehicles. (Standard 72" bed pictured.)



(Standard 72" bed pictured.)



Optional Remotes Available

The K&K Vehicle Mounted Arrow Board has a standard built-in controller that is located on the lower right corner of the panel face. However, optional wireless or wired remotes are available for easy operation and mode selection.

Vehicle Mount Arrow Board - Specifications

Model # AV254896



Controller

Battery Status Indicator Light: Indicates if solar is charging and progress. Multi-color LED indicates the battery condition (low, fair, or good).

Error LED: Indicates low voltage disconnect, low voltage disconnect 2, or over voltage condition

Mode Selector: Capable of 13 modes in 25 lamp configuration

Sign Display

Construction: Height: 48"

Length: 96"

Width: 3 3/8"

Material:

- .080 Aluminum frame 48"x96" w/ (2) 47³/₄" cross members
- Three Millimeter Aluminum front panel 48"x96"
- Three Millimeter Aluminum back panel 48"x96"

Salt Spray Fog: 1,000 hours

UV Resistance: 500 hours

LED bulbs: (25) yellow/amber Par 46 LED's with 360° high impact plastic visor. Push on type connectors to prevent separation due to vibration during travel and operation.

Options

- ▶ Three small amber indicator lights added to the back of display.
- ▶ Convert Vehicle Mounted Arrow Boards to AC by adding 20W power supply (includes wiring).
- ▶ Upgrade to 25' wiring harness data cable.
- ▶ Upgrade to 40' wiring harness data cable.
- ▶ Upgrade to 60' wiring harness data cable.
- ▶ Hitch mount.
- ▶ Low profile mount.
- ▶ Over cab mount. Also requires (low profile mount)
- ▶ Upgrade to 60' wiring harness data cable.
- ▶ Tailgate mount.
- ▶ Actuator for Vehicle Mounted Arrow Board – 600 lb; includes 12' cable.
- ▶ Upgrade to 25' actuator cable.
- ▶ Upgrade to 40' actuator cable.
- ▶ Upgrade to 60' actuator cable.
- ▶ Two-tube frame for rail mount.



888.414.3003 toll-free • 662.566.2025 phone • 662.566.7123 fax
www.k-ksystems.com • sales@k-ksystems.com

K&K Systems

Systems

QUOTATION

687 Palmetto Road
Tupelo, MS 38801
www.k-ksystems.com

email: ali@k-ksystems.com
Phone: 662-566-2025
Fax: 662-566-7123 TollFree: 888-414-3003

Quotation #: **Q190618AB-2-NE-STATEOFNEBRASKA**
Quotation Date: **6/18/2019**
Customer Type: **Your Cost**

Customer Contact: **RENE BOTTS**
Quote Valid: **45 days**
Prepared by: **Ali Bingham**

<u>Bill To:</u>	<u>Ship To:</u> (Update if different than Bill To address)
Name: Rene Botts Company Name: State of Nebraska Street Address: State Purchasing Bureau Address 2: 1526 K Street, Suite 130 City, ST ZIP Code: Lincoln, NE 68508 Tel: 402-471-6500 Cell: Fax: 402-471-2089 email:	Name: Rene Botts Company Name: State of Nebraska Street Address: State Purchasing Bureau Address 2: 1526 K Street, Suite 130 City, ST ZIP Code: Lincoln, NE 68508 Tel: 402-471-6500 Cell: Fax: 402-471-2089 email:

Product

<u>Model #</u>	<u>Description</u>	<u>Base Price</u>
AV253060	Vehicle Mount 25 Lamp par 46 (LED) Arrow Board. Sign dimensions are 32" x 60" all aluminum fabrication with black powder coat finish to give smooth look. Also comes with 360 degree visors, and built-in controller.	\$3,834.40

Packaging

K&K Delivers

Options and Accessories - PER UNIT

<u>QTY per Unit</u>	<u>Item #</u>	<u>Description</u>	<u>Price Each</u>	<u>Price per Unit</u>
1	AS2000-WKIT	Wired handheld controller for AS2000 only. Includes 15' Ethernet Cable (RJ45C15)	INCLUDED	INCLUDED
1	AVSM	Skid Mount Frame.	INCLUDED	INCLUDED
1	RJ45C40	40' Cat 5E Molded Snagless Patch Cable Black - Professional Series - 50 Micron gold Plated RJ45 Connectors	INCLUDED	INCLUDED
1	DDB	Drop-down box for controller. (Controller not included) Mounting hardware included.	INCLUDED	INCLUDED

Special Notes

Terms of Purchase

FOB: Tupelo, MS 38801
Delivery (weeks): 4-6 Weeks
Warranty: 1 year limited warranty, Factory Depot

Per System Total: \$3,834.40
Total QTY of Systems: 10 \$38,344.00
Total Shipping Costs: **INCLUDED**
Taxes: 7.00%
GRAND TOTAL: \$38,344.00

Sales Person Signature:

Work Order#

Sales Manager Signature: Timothy Keith

Client PO#

Please note: The above specifications and quotation does not include shipping, permits, or taxes unless otherwise stated. The freight charge is an approximate estimate for your reference; the actual charge may vary. There will be an additional 3% charge on all credit card orders unless otherwise stated. *Lead-time committed is based on the date Purchase Order is received by K&K Systems and deposit made and/or credit approved. Lead time is not based on the date quoted.



Vehicle Mount Arrow Board Model # AV253060

Features

- ▶ Arrow Board Meets MUTCD
- ▶ Photocell for Auto Dimming
- ▶ Super Bright LED Technology
- ▶ Easy to Operate & Maintain Arrow Board
- ▶ 7 or 12 Function Control Arrow Board
- ▶ Powder Coat Paint
- ▶ 360 Degree LED visors
- ▶ 30-40 Flash Rate
- ▶ Numerous Size and Mounting Options
- ▶ Durable Finish Resist the Elements
- ▶ Lightweight Arrow Board



(Standard 72" bed pictured.)



Optional Remotes Available

The K&K Vehicle Mounted Arrow Board has a standard built-in controller that is located on the lower right corner of the panel face. However, optional wireless or wired remotes are available for easy operation and mode selection.



888.414.3003 toll-free • 662.566.2025 phone • 662.566.7123 fax
www.k-systems.com • sales@k-systems.com



Vehicle Mount Arrow Board - Specifications

Model # AV253060



Controller

Battery Status Indicator Light: Indicates if solar is charging and progress. Multi-color LED indicates the battery condition (low, fair, or good).

Error LED: Indicates low voltage disconnect, low voltage disconnect 2, or over voltage condition

Mode Selector: Capable of 13 modes in 25 lamp configuration

Sign Display

Construction: Height: 30"

Length: 60"

Width: 3 3/8"

Material:

- .080 Aluminum frame 30"x60" w/ (2) 35³/₄" cross members
- .063 Aluminum front panel 30"x60"
- .063 Aluminum front panel 30"x60"

Salt Spray Fog: 1,000 hours

UV Resistance: 500 hours

LED bulbs: (15) yellow/amber Par 46 LED's with 360° high impact plastic visor. Push on type connectors to prevent separation due to vibration during travel and operation.

Options

- ▶ **Three small amber indicator lights added to the back of display.**
- ▶ **Convert Vehicle Mounted Arrow Boards to AC by adding 20W power supply (includes wiring).**
- ▶ **Upgrade to 25' wiring harness data cable.**
- ▶ **Upgrade to 40' wiring harness data cable.**
- ▶ **Upgrade to 60' wiring harness data cable.**
- ▶ **Hitch mount.**
- ▶ **Low profile mount.**
- ▶ **Over cab mount. Also requires (low profile mount)**
- ▶ **Upgrade to 60' wiring harness data cable.**
- ▶ **Tailgate mount.**
- ▶ **Actuator for Vehicle Mounted Arrow Board – 600 lb; includes 12' cable.**
- ▶ **Upgrade to 25' actuator cable.**
- ▶ **Upgrade to 40' actuator cable.**
- ▶ **Upgrade to 60' actuator cable.**
- ▶ **Two-tube frame for rail mount.**



888.414.3003 toll-free • 662.566.2025 phone • 662.566.7123 fax
www.k-k-systems.com • sales@k-k-systems.com

Options for Arrow Boards - Vehicle Mounted

<u>A3BL</u>	Three small amber indicator lights added to the back of display. Additional wiring included.
<u>AC-ABV</u>	Convert Vehicle Mounted Arrow Boards to AC by adding 20W power supply (includes installation) with access door.
<u>ADDB100W</u>	Add one (1) 100A sealed battery, battery cabinet, and wiring harness.
<u>ADD10W-KIT</u>	Replace 10 watt top solar panel with 20 watt solar panel for a total 30 watt system. Includes wiring, mounting brackets and bolts.
<u>ADD20W-KIT</u>	Replace 10 watt top solar panel with 30 watt solar panel for a total 40 watt system. Includes wiring, mounting brackets and bolts.
<u>ADD30W-KIT</u>	Replace 10 watt top solar panel with 40 watt solar panel for a total 50 watt system. Includes wiring, mounting brackets and bolts.
<u>ADD-BCC-AB</u>	Cabinet for battery and battery charger to be added to back of 32x60 arrow board. Includes charger protective plug cover and mounting hardware.
<u>ADDPP</u>	Add power pack to include two (2) 10 watt solar panels, one (1) 18 amp battery, additional wiring, mounting hardware and access door.
<u>AS2000-RFKIT</u>	Wireless handheld controller for AS2000 only that has RF. Includes Super 2000 RF Host (AS2000-RF-HOST)
<u>AS2000-TWKIT</u>	TruWireless. Consists of: AS2000-RFKIT; 18A 12V battery; two 10 watt solar panel kits; access door.
<u>AS2000-WKIT</u>	Wired handheld controller for AS2000 only. Includes 15' Ethernet Cable (RJ45C15)
<u>BCH-1212-KIT</u>	12 amp battery charger with protective plug cover and mounting hardware.
<u>DDB</u>	Drop-down box for controller. (Controller not included) Mounting hardware included.
<u>2PIN</u>	2 pin flat power connector (plugs into trailer connector)
<u>PC-20</u>	Power cable - 20'. (Replace 15' with 20' power cable.)
<u>PC-30</u>	Power cable - 30'. (Replace 15' with 30' power cable.)
<u>RJ45C15</u>	15' Cat 5E Molded Snagless Patch Cable Black - Professional Series - 50 Micron gold Plated RJ45 Connectors
<u>RJ45C25</u>	25' Cat 5E Molded Snagless Patch Cable Black - Professional Series - 50 Micron gold Plated RJ45 Connectors
<u>RJ45C40</u>	40' Cat 5E Molded Snagless Patch Cable Black - Professional Series - 50 Micron gold Plated RJ45 Connectors

Mounting Options

<u>M-AVTGM</u>	Tailgate mount. (Board must not cover tail lights)
<u>M-HMLP</u>	Hitch mount low profile assembly. Recommended for 32X60 board. (Board must not cover tail lights)
<u>M-HMHP</u>	Hitch mount high profile assembly.
<u>M-LP-A</u>	Mount - low profile. Auto raise/lower, 12V linear actuator with built-in limit switches and 6" stroke.
<u>M-90-M</u>	Mount - 90 degree. Manual raise/lower.
<u>M-90-A</u>	Mount - 90 degree. Auto raise/lower, 12V linear actuator with built-in limit switches and 6" stroke.
<u>M-180-M</u>	Mount - 180 degree. Manual raise/lower.
<u>M-180-A</u>	Mount - 180 degree. Auto raise/lower, 12V linear actuator with built-in limit switches and 6" stroke.
<u>M-LE-LP</u>	Leg extensions for low profile mounts (Includes U-bolts, center crossbar and top crossbars)
<u>M-VTTM</u>	Two (2) tubes for rail mount.
<u>SCORPION</u>	Scorpion mount; manual; actuator
<u>VORTEC</u>	Vortec mount; manual; actuator

K & K SYSTEMS, INC.

687 Palmetto Road, Tupelo, MS 38801

662-566-2025 Phone 662-566-7123 Fax 1-888-414-3003 Toll Free

www.k-ksystems.com

info@k-ksystems.com

MANUFACTURER'S WARRANTY

1. The manufacturer warrants that all products manufactured by K & K Systems, Inc. will be free from defects in material and workmanship for a period of two (2) years from date of shipment, subject to the conditions and restrictions contained herein.
2. This warranty does not apply to a product that has not been installed or maintained in accordance with the manufacturer's instructions, has been subjected to damage in an accident, abused or neglected during operation, repaired or modified by persons other than manufacturer, its employees or authorized agents, or failed to have normal maintenance.
3. The buyer expressly agrees that the buyer's sole remedy and the manufacturer's sole responsibility, in respect to a warranty claim, is exclusively limited to repair or replacement at the manufacturer's option, of product or a portion thereof found by the manufacturer to be defective. The manufacturer is not responsible for labor or other expended charges by buyer including transportation charges, and shall not be liable for any incidental or consequential damages connected with repair of a product deemed to be defective or with installation or replacement of repaired product. Further, the manufacturer disclaims any liability for any incidental or consequential damages, including lost or duplicated time or expense accruing for any reason, to the owner or user of any products sold by the manufacturer, whether claim is made in contract or in tort or under any theory of warranty, negligence or otherwise.
4. The manufacturer reserves the right to make changes in its products from time to time, without incurring any obligation to incorporate such improvements in any products previously sold or in service.
5. The terms and conditions of the warranty cannot be altered without the written consent of the manufacturer.
6. The foregoing warranty is exclusive and in lieu of all other express, statutory and implied warranties **INCLUDING THOSE OF MERCHANTABILITY AND FITNESS FOR ANY PARTICULAR PURPOSE.** There are no warranties which extend beyond the language in the previous six (6) paragraphs.

If you have any further questions, please feel free to call us at our toll-free number of 888-414-3003, email info@k-ksystems.com or you might want to look us up on the Internet at www.k-ksystems.com.

K&K Systems, inc.

TRUWIRELESS

MOUNT & GO VEHICLE ARROW BOARD

The Industry's First Completely Wireless Arrow Board



K&K Systems, inc.
Traffic Safety Products Manufacturer

There are many reasons our design team developed the TruWireless Arrow Board. Your safety and convenience is always at the top of our list. TruWireless literally lets you **Mount & Go**. We combined solar power and wireless connectivity for a completely wireless design eliminating all wiring that runs to the vehicle. TruWireless is available in all of our standard arrow board sizes. For your next purchase, choose **TRUWIRELESS**.

K&K Systems, inc.

TRUWIRELESS

MOUNT & GO VEHICLE ARROW BOARD

Mount TruWireless to your vehicle and you're set to go. The unit automatically powers on raising the display when you select an arrow mode on the wireless remote. Select OFF mode to lower the panel. It's that easy. TruWireless uses solar energy stored in maintenance-free batteries concealed within the arrow board display making TruWireless an all-in-one unit that can be easily mounted, removed, and remounted to a different vehicle quickly.

Solar panels provide power without the need of the vehicle's battery. K&K solar panels utilize the most up-to-date solar technology and electronics to maintain power levels through rain, sleet, heavy snow or strong winds. A built-in blocking diode prevents the reverse flow of electricity. The solar panel's heavy-duty aluminum frame makes it weather resistant.

TruWireless uses our wireless remote controller not only allows you to select from several arrow patterns, but also provides information for battery status and condition, solar charging and progress, and errors. The Mode Selector is capable of 8 arrow patterns for 15 lamp models or 13 patterns for 25 light models that are set by simply turning the switch.



Actuator auto raises with power ON and lowers with power OFF

Cushioned supports

Photocell for auto-dimming

FEATURES

- ▶ Easy installation - Mount and Go design
- ▶ Low profile mount for less wind drag when not in use
- ▶ Remote Controller works up to 700 ft.
- ▶ On-board controller for operation without remote
- ▶ Low energy consuming LEDs with max light output
- ▶ Photocell for auto dimming
- ▶ Easy operation - 8 or 13 arrow patterns
- ▶ Durable powder coat finish
- ▶ 360° LED visors
- ▶ Meets MUTCD standards

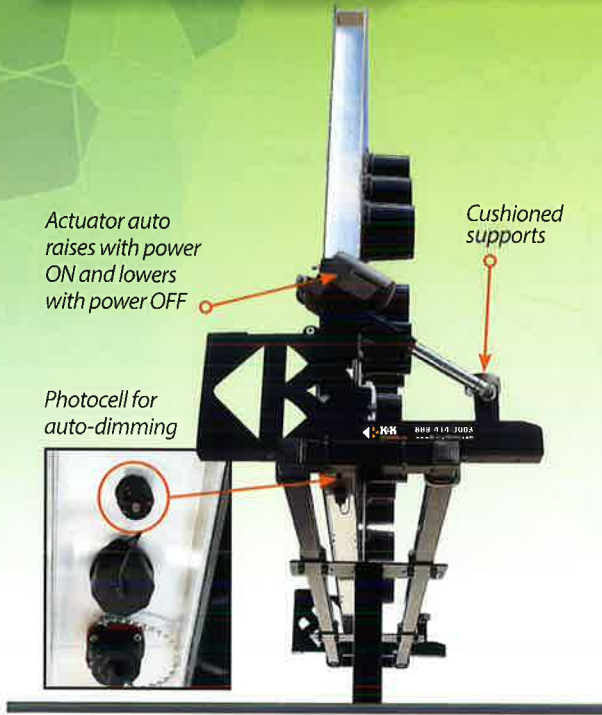

Battery access panels

Two 10 watt solar panels charge the unit in use and in transit



Low Profile Mount



Shown with over the cab mount leg extensions



TRAILER-MOUNTED ARROW BOARD OPERATING MANUAL

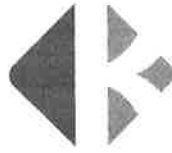
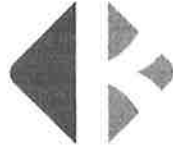

TABLE OF CONTENTS

THANK YOU	4
INTRODUCTION.....	5
POWER SUPPLY.....	5
TRAILER.....	5
SAFETY/WARNINGS/PROCEDURES	6
BATTERY SAFETY.....	6
BATTERY CHARGER SAFETY	6
SOLAR SAFETY	6
TOWING AND LONG TERM STORAGE	7
SETUP SINGLE MAST TRAILER.....	8
SETUP FOLDING TRAILER.....	9
ARROW BOARD FUNCTIONS	10
ARROW BOARD FUNCTIONS CONTINUED.....	11
OPTIONAL WIRELESS REMOTE	12
OPTIONAL WIRED REMOTE.....	13
MAINTENANCE	14
FREQUENTLY ASKED QUESTIONS.....	15
TROUBLESHOOTING	16
WIRING DIAGRAM	17
WARRANTY	18



Thank you for your business!

To Our Valued Customer,

K&K Systems, Inc. is excited that you have purchased our product.

Our company has been serving the traffic industry since 1997. Since that time we have risen to become a leader in the traffic industry. We offer a complete line of traffic safety products that include message boards, arrow boards, radar speed monitors, solar school zone flashers, solar 24-hour flashers and many other quality products that serve our industry today.

At K&K Systems, Inc., we strive to improve the quality of our products. We are dedicated to the concept that our customers are our most valuable resource. We strive to serve our customers as we would want to be served.

Tim Keith,
President



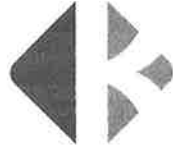

INTRODUCTION

ARROW BOARD

This trailer mounted (LED) arrow board is solar powered with a smart charge controller. The sign dimensions are 48" x 96". It is fabricated from aluminum with a flat black powder coat finish to give a smooth look and prevent rust. Our standard systems have 36 amps of battery backup power and (4)-four swivel type jacks – one on each corner of the trailer and (1) one tongue jack.

Our Standard arrow board comes with a 40 watt of solar in addition to the battery system. The solar panel provides a charge to the battery bank while exposed to the sun. It has LVD (low voltage disconnect). An optional 12-60 amp, fully automatic, battery charger can be used instead of the solar panels or when system is not exposed to direct sunlight for an extended period of time.

BATTERY COMPARTMENT

The battery is located inside the arrow board for a smooth look and to deter theft and vandalism.

POWER SOURCE

Our products incorporate a battery pack wired for 12V operation, depending on the requirements of the design. The battery bank is regulated by and protected by a solid-state charge controller/low voltage disconnect. This prevents gassing and over discharging of the batteries, which can result in premature failure. A thermal compensation and related circuitry adjusts the charge rate of the system with variances in temperature.

TRAILER

The trailer is fabricated from tubular steel and coated with safety orange, black or white powder coat paint (other colors available upon request). The trailer is equipped with a tubular steel axle. Adjustable jacks are mounted at each corner of the trailer. The tail lights are dual combination reflective lights with stop, tail and turn signal. The wheels are five lug wheels and tires are sized appropriately.

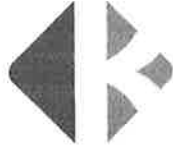

SAFETY / WARNINGS / PRECAUTIONS

The following are recommendations for the safe and responsible use of K&K Systems' trailer units.

- Periodically inspect the trailer. This includes but is not limited to wheels, tongue, pins safety chains and taillights.
- Traffic cones or barricades should first be setup before arrow board is erected.
- The trailer should always be properly set up and leveled with the jack stands before the arrow board is erected, where applicable.
- Periodically check all nuts, bolts, cable clamps, etc. and tighten/ repair/ replace when necessary, where applicable.
- Always tow the unit in the down position, where applicable.
- Always use safety chains and properly sized hitch ball when towing unit.
- Always check water level in batteries and clean solar panel.

Please remember that the best assurance against accidents is a careful and responsible operator.

BATTERY SAFETY

It is important that you know that, while 12 VDC is not likely to cause electrical shock, these batteries can produce unbelievable amounts of current that can instantly melt large tools, burn wires, and heat jewelry to skin searing temperatures. Batteries produce hydrogen gas in the course of normal operation and will explode under certain conditions with disfiguring consequences. One component of a battery, sulfuric acid, will permanently damage clothing, corrode metal, severely irritate your skin, and blind you if it gets into your eyes. You should become familiar with how batteries operate so that you will know how to avoid the dangerous characteristics of a battery.

BATTERY CHARGER SAFETY *(optional)*

If optional battery charger is installed the battery charger is preset in automatic position. DO NOT CHANGE THESE SETTINGS because of possible overcharging of batteries. Plug cord into a standard 120 volt AC for charging.

SOLAR SAFETY

To reduce the risk of shock or burn during maintenance, solar panels should be covered with an opaque material and power converter/battery charger should be disconnected from AC power supply.

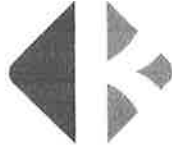

TOWING AND LONG-TERM STORAGE

TOWING

Failure to follow instructions exactly can cause ball failure or loss of attachment resulting in vehicle crash and/or personal injury.

Use this hitch ball only for towing trailers or vehicles connected to the ball with a socket-type coupler.

Ball diameter must match coupler socket size.

Do not exceed gross trailer weight shown on ball.

Improper tightening can cause ball failure or loss of attachment.

- Threaded shank must protrude beyond bottom of nut when tightened. If it does not, ball shank is too short for the application and loss of attachment may occur.
- Check nut tightness every time you hook up the trailer and at the beginning of each towing day, tow only if nut is tightened as specified.
- Replace any damaged or work part (except finish).
- Never attach a tow rope, chain or stretch type elastic rope to hitch ball.
- Do not fasten trailer safety chain or other type of attachment to or with, the ball.
- Lubricate ball and coupler to minimize wear and friction, coupler must not bind on ball.

This product complies with V.E.S.C. Regulation V-5, C.S.A. Standard D-264 and the Safety Specifications and Requirements for Connection Devices and Towing Systems.

Failure to follow instructions exactly can cause ball failure or loss of attachment resulting in vehicle crash and/or personal injury. Use this hitch ball only for towing trailers or vehicles connected to the ball with a socket-type coupler.

LONG-TERM STORAGE

When the sign is to be stored for extended periods of time, the POWER switch should be turned off, and the solar charge controller should be left on, allowing the solar panel array to continuously charge the sign battery bank. If possible, place the unit in a sunny area to allow the unit to maintain the charge on the batteries. When the sign is to begin operation again, a thorough inspection of all systems is advised before the sign is towed to the job site. Check battery state of charge to confirm over 12 volts.

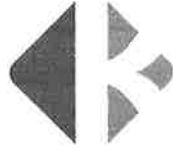

SETUP FOR SINGLE MAST TRAILER

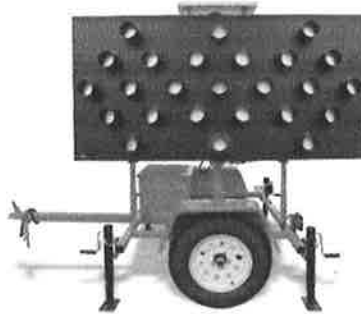

Caution: If there is any portion of this instruction guide that is not understood, contact your local dealer or manufacturer.

BEFORE BEGINNING TRAILER SETUP:

1. Check Battery Level indicator "Status" LED located on the Face of arrow board panel.

The battery status indicator:

- Red color indicates the battery voltage is low.
- Blue color indicates the battery voltage is fair.
- Green color indicates the battery voltage good.

2. Power on unit and set to desired arrow board pattern using controller on face of arrow board or if unit came with optional hardwired or wireless controller use those controls.
3. Make sure all bulbs are working properly in the pattern you chose.

TRAILER SETUP

1. Position trailer in desired location so that the unit is directed toward traffic.
2. Unhook trailer from vehicle, blocking wheels first.
3. Use jacks to brace and level trailer.
4. Remove tongue from trailer (if desired).
5. Pull out on the spring loaded release pin & winch up the display until it automatically locks in place.
6. Release the hand brake behind the display and rotate facing traffic.
7. Reapply the hand brake to lock the display in place.



Hand Brake

Spring Loaded Release Pin

To return the display to the travel position, release the hand brake and rotate the display to the travel position then reapply the hand brake to lock into place. Release the pin & winch down the display until it automatically locks.



SETUP FOR FOLDING TRAILER

Caution: If there is any portion of this instruction guide that is not understood, contact your local dealer or manufacturer.

BEFORE BEGINNING TRAILER SETUP:

1. Check charge controller/battery level located on the left side of the arrow board panel.
2. Power on unit and set to desired arrow board pattern using controller.
3. Make sure all bulbs are working properly in the pattern you chose.

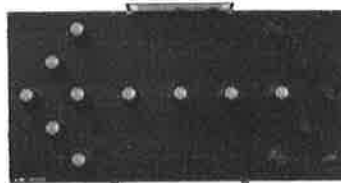

TRAILER SETUP

1. Position trailer in desired location so that the unit is directed toward traffic.
2. Remove trailer from vehicle, blocking wheels first.
3. Use jacks to brace and level trailer.

ELEVATING SIGN *(if applicable)*

1. Verify that the sign is in proper position and that the entire unit is level.
2. Clear all unnecessary personnel from sign area to ensure safety.
3. Remove safety pin from support frame.
4. Locate crank winch located on support frame.
5. Rotate crank winch to raise sign until sign is in its full upright position.
6. Replace safety pin into the support frame.



LOWERING SIGN *(if applicable)*

1. Verify that the sign is in proper position and that the entire unit is level.
2. Clear all unnecessary personnel from sign area to ensure safety.
3. Remove safety pin from support frame.
4. Locate crank winch located on support frame.
5. Rotate crank winch to lower sign until sign is in its horizontal position.
6. Replace safety pin into the support frame.



ARROW BOARD FUNCTIONS

FRONT PANEL CONTROLS

DISPLAY SELECTOR SWITCH

This is the only switch on the unit and is used to select one of the display patterns or turn the unit off. The display patterns are listed below:

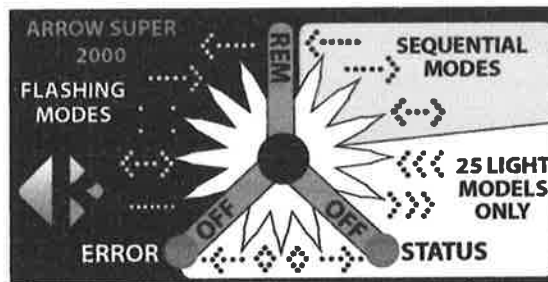

15 LIGHT PATTERNS:

- Warning Bar or Caution Bar - 7 horizontal lamps flashing in unison.
- Double Arrow - 5 lamps in each arrow head and 3 lamps in a common shaft all flashing in unison.
- Four Point Caution - 4 outermost corner lamps flashing in unison.
- Right Arrow - 10 lamps flashing in unison, forming an arrow.
- Left Arrow - 10 lamps flashing in unison, forming an arrow.
- Sequencing Arrow Left - 5 lamps in the arrow head and 5 lamps in the shaft sequencing left.
- Sequencing Arrow Right - 5 lamps in the arrow head and 5 lamps in the shaft sequencing right.
- Sequencing Double Arrow with arrow shaft sequencing left and right to arrow heads left and right consisting of 5 lamps per arrow head.
- All unused positions and 25 Lamp sequential patterns listed below are considered OFF for 15 lamp signs.

25 LIGHT PATTERNS: (includes all 15 light patterns plus the following)

- Sequencing Chevron Left - 3 chevrons of 5 lamps each, sequencing in a right to left direction.
- Sequencing Chevron Right - 3 chevrons of 5 lamps each, sequencing in a left to right direction.
- Sequencing arrow head moving right with 5 lamps in arrow head
- Double Diamond - 2 sets of 8 lamps forming two diamonds flashing alternately.
- Sequencing arrow head moving left with 5 lamps in arrow head
- All unused positions are considered OFF.

***For the Optional remote controller wired or wireless to take command, this switch must be in the single off position center pointing up (12:00). If not in this position the remote controller will not function.*

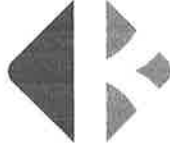

LED INDICATORS

There are 2 LEDs, one indicates current battery status and the other indicates an error condition. Details of operation are listed as follows.

BATTERY STATUS INDICATOR

A single multi-color LED displays the status of the battery at a glance. A constant on condition indicates charging from the solar panel is happening. A flashing condition will indicate that the battery is not being charged.

- *Red color indicates the battery voltage is low.*
- *Blue color indicates the battery voltage is fair.*
- *Green color indicates the battery voltage good. Maximum Battery Voltage is determined.*

ERROR LED

This red LED indicates one of the following errors.

LVD1 (Low Battery Voltage Detected) (-)

When the battery voltage falls below the set point this LED begins flashing.

During LVD1 the unit discontinues flashing of the selected arrow pattern and begins displaying the 4 corners lamp pattern. This will continue until the battery voltage increases to the recovery voltage. At this time the unit will resume normal operation and the error LED will go off.

LVD2 (Low Battery Voltage Disconnect) (--)

When the battery voltage falls below the LVD2 voltage this LED begins double flashing. During LVD2 the unit discontinues flashing of the 4 corners pattern and goes into a low power state and all the lamps are off. This will continue until the battery voltage increases to the recovery point. When this happens the unit will resume normal operation and the error LED will go off.

OV (Over Voltage Condition)

When the battery voltage rises above the Max Battery Voltage (MBV), as determined by the battery voltage and temperature, this error LED will illuminate continuously. The unit will continue to operate in a normal fashion. If the battery voltage falls below MBV the error LED will go off. This is a condition that should not occur and the unit should be removed from service until the problem is resolved.

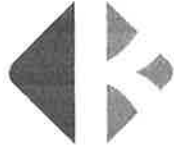

OPTIONAL WIRELESS REMOTE



Selection Knob to select desired function



1. To begin you need to place the Arrow Super 2000 Controller selection knob to the RMT position (Center up).
2. When it is moved to that position you have 60 secs to initiate pairing.
3. Once the Controller is ready for pairing you need to remove the battery cover on the RF-Hand Held unit to expose the pairing switch and yellow pairing LED.
4. Press the pairing switch until the yellow LED comes on and then release. The pairing yellow led should respond with two or three rapid flashes to indicate a successful pairing. It will remain on steady for another 10-15 seconds and go out. If pairing failed, the pairing led will rapidly flash 5-6 times in rapid succession. To try again go to step 1.

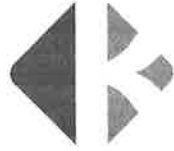

OPTIONAL WIRED REMOTE

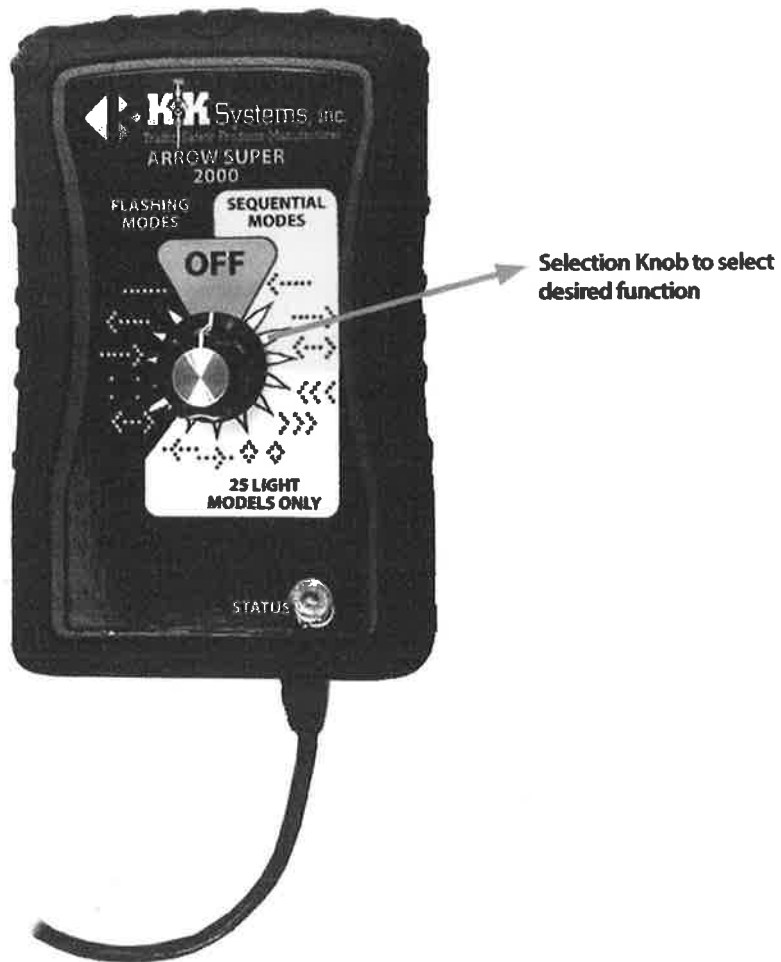



MAINTENANCE

BATTERIES

The batteries are located in the battery compartment on the back of the arrow board.

To replace the batteries:

1. Remove the battery compartment cover with a Phillips head screw driver.
2. Locate the wiring connectors.
3. Remove the wires from the connector by lifting the orange locking switch.
4. Remove the wires from the battery poles by gently sliding the connector off of the clip.
5. Lift the battery out.
6. Remove the poles connectors and install on the new battery.
7. Place the new batteries into the compartment.
8. Reconnect the proper wire connectors to the pole clips.
9. Reconnect the proper wires to the wiring connectors.
10. Replace the compartment cover.

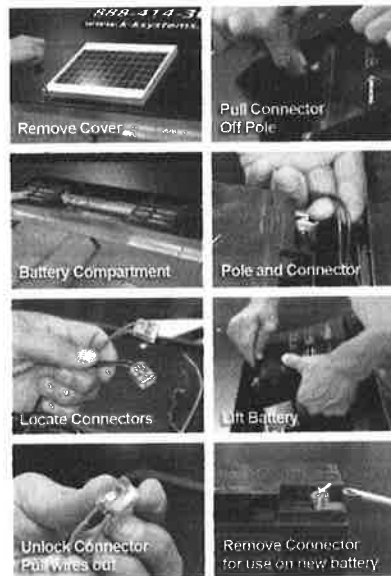

SOLAR PANELS

During operation, keep the module clean of excessive dirt and debris by using only soapy water and a soft cloth or sponge. Periodically check the integrity of wiring connections in the junction box. Inspect for signs of damage to module glass or frame.

TRAILER

Periodically inspect wheels, tires, axle assembly, wheel bearings, taillights, tongue, safety chains and all components related to safe towing. Check tightness of all nuts and bolts; replace worn parts when necessary.

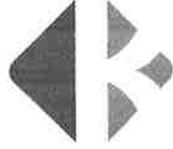

FREQUENTLY ASKED QUESTIONS

Please see FAQ's under specific model on website
www.k-systems.com

TROUBLESHOOTING ARROW BOARD

When the arrow board is first powered on, if the unit does not power on, then check the following:

1. **That the mode selection switch is not in "Lamps Off" position.**
2. **Check Battery or Batteries connections.**
3. **Check "Status" LED indicator located on arrow board face.**

A single multi-color LED displays the status of the battery at a glance. A constant on condition indicates charging from the solar panel is happening. A flashing condition will indicate that the battery is not being charged.

- Red color indicates the battery voltage is low.
- Blue color indicates the battery voltage is fair.
- Green color indicates the battery voltage good. Maximum Battery Voltage is determined.

4. **Check "Error" LED indicator located on arrow board face.**

LVD1 (Low Battery Voltage Detected) (-)

When the battery voltage falls below the set point this LED begins flashing. During LVD1 the unit discontinues flashing of the selected arrow pattern and begins displaying the 4 corners lamp pattern. This will continue until the battery voltage increases to the recovery voltage. At this time the unit will resume normal operation and the error LED will go off.

LVD2 (Low Battery Voltage Disconnect) (--)

When the battery voltage falls below the LVD2 voltage this LED begins double flashing. During LVD2 the unit discontinues flashing of the 4 corners pattern and goes into a low power state and all the lamps are off. This will continue until the battery voltage increases to the recovery point. When this happens the unit will resume normal operation and the error LED will go off.

OV (Over Voltage Condition)

When the battery voltage rises above the Max Battery Voltage (MBV), as determined by the battery voltage and temperature, this error LED will illuminate continuously. The unit will continue to operate in a normal fashion. If the battery voltage falls below MBV the error LED will go off. This is a condition that should not occur and the unit should be removed from service until the problem is resolved.

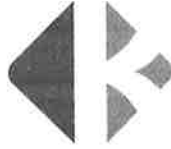

FREQUENTLY ASKED QUESTIONS

*Please see FAQ's under specific model on website
www.k-k-systems.com*

TROUBLESHOOTING ARROW BOARD

LAMP OUT (LED)

If lamp is not lit when it should be on, first suspect burned out lamp. Disconnect power. Loosen the four screws holding the hood in place. Remove the lamp and loosen the two terminal screws. Remove the wires and connect the new lamp terminals. Fit lamp into the sign with the lamp tab properly seated in the notch in the sign panel. Only this orientation projects the light out toward the motorist at the correct viewing angles.

STEADY BURN LAMP (LED)

Disconnect control power cable. Check for grounded or shorted wires and replace or repair where needed.

MANY LAMPS OUT (LED)

1. Suspect poor battery connections.
2. Possible internal wiring harness damage.

TROUBLESHOOTING TOOLS NEEDED:

1. Digital voltmeter
2. Phillips head screwdriver
3. Straight screwdriver
4. Crescent wrench

Questions? Please email service@k-k-systems.com or call 888-414-3003.

Disclaimer of Liability

We at K&K Systems have taken precautions to insure that the K&K Systems products are safe and reliable. However, we cannot be held responsible for any injuries or accidents as a result of the use or misuse of this product. It is the user's responsibility to insure that this product is used in a safe and responsible manner and to understand that he/she is the only liable party. Any liability of K&K Systems is limited strictly to the Manufacturer's Warranty attached. K&K Systems, Inc., reserves the right to make any changes to this product, user guide or specifications without notice.

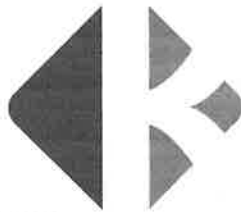

K&K Systems, inc.
Traffic Safety Products Manufacturer

687 Palmetto Rd.
Tupelo, Mississippi 38801

office: 662.566.2025
fax :662.566.7123
toll-free: 888.414.3003

email: sales@k-systems.com
www.k-systems.com

INVITATION TO BID

Number 6093 OF

The State of Nebraska (State), Department of Administrative Services (DAS), Materiel Division, State Purchasing Bureau (SPB), is issuing this solicitation for a Commodity contract, ITB Number 6093 OF for the purpose of selecting a qualified Contractor to provide Truck Mounted Sequential Flashing Arrow Board. A more detailed description can be found in Section VI. The resulting contract may not be an exclusive contract as the State reserves the right to contract for the same or similar goods from other sources now or in the future.

INFORMATION PERTINENT TO THIS SOLICITATION CAN BE FOUND ON THE INTERNET AT:

<http://das.nebraska.gov/materiel/purchasing.html>

IMPORTANT NOTICE: Pursuant to Neb. Rev. Stat. § 84-602.02, State contracts in effect as of January 1, 2014, and contracts entered into thereafter, must be posted to a public website. The resulting contract, the solicitation, and the successful Contractor's proposal or response will be posted to a public website managed by DAS, which can be found at:

<https://statecontracts.nebraska.gov>

In addition and in furtherance of the State's public records statute (Neb. Rev. Stat. § 84-712 et seq.) all proposals or responses received regarding this solicitation will be posted to the SPB website.

These postings will include the entire bid response. Contractor must request that proprietary information be excluded from the posting. The Contractor must identify the proprietary information, mark the proprietary information according to state law, and submit the proprietary information in a separate container or envelope marked conspicuously using an indelible method with the words "PROPRIETARY INFORMATION". The Contractor must submit a **detailed written document showing that the release of the proprietary information would give a business advantage to named business competitor(s) and explain how the named business competitor(s) will gain an actual business advantage by disclosure of information.** The mere assertion that information is proprietary or that a speculative business advantage might be gained is not sufficient. (See Attorney General Opinion No. 92068, April 27, 1992) **THE CONTRACTOR MAY NOT ASSERT THAT THE ENTIRE BID RESPONSE IS PROPRIETARY. COST WILL NOT BE CONSIDERED PROPRIETARY AND IS A PUBLIC RECORD IN THE STATE OF NEBRASKA.** The State will then determine, in its discretion, if the interests served by nondisclosure outweighs any public purpose served by disclosure. (See Neb. Rev. Stat. § 84-712.05(3)) The Contractor will be notified of the agency's decision. Absent a State determination that information is proprietary, the State will consider all information a public record subject to release regardless of any assertion that the information is proprietary.

If the agency determines it is required to release proprietary information, the Contractor will be informed. It will be the Contractor's responsibility to defend the Contractor's asserted interest in non-disclosure.

To facilitate such public postings, with the exception of proprietary information, the State of Nebraska reserves a royalty-free, nonexclusive, and irrevocable right to copy, reproduce, publish, post to a website, or otherwise use any contract, bid response to this solicitation for any purpose, and to authorize others to use the documents. Any individual or entity awarded a contract, or who submits a bid response to this solicitation, specifically waives any copyright or other protection the contract or bid response to the solicitation may have; and, acknowledges that they have the ability and authority to enter into such waiver. This reservation and waiver is a prerequisite for submitting a bid response to this solicitation, and award of a contract. Failure to agree to the reservation and waiver will result in the bid response to the solicitation being found non-responsive and rejected.

Any entity awarded a contract or submitting a bid response to the solicitation agrees not to sue, file a claim, or make a demand of any kind, and will indemnify and hold harmless the State and its employees, volunteers, agents, and its elected and appointed officials from and against any and all claims, liens, demands, damages, liability, actions, causes of action, losses, judgments, costs, and expenses of every nature, including investigation costs and expenses, settlement costs, and attorney fees and expenses, sustained or asserted against the State, arising out of, resulting from, or attributable to the posting of the contract or the bid responses to the solicitation, awards, and other documents.

TABLE OF CONTENTS

INVITATION TO BID.....	i
TABLE OF CONTENTS.....	ii
GLOSSARY OF TERMS.....	iv
ACRONYM LIST.....	viii
I. PROCUREMENT PROCEDURE.....	1
A. GENERAL INFORMATION.....	1
B. PROCURING OFFICE AND COMMUNICATION WITH STATE STAFF AND EVALUATORS.....	1
C. SCHEDULE OF EVENTS.....	2
D. WRITTEN QUESTIONS AND ANSWERS.....	2
E. SECRETARY OF STATE/TAX COMMISSIONER REGISTRATION REQUIREMENTS (Statutory).....	2
F. ETHICS IN PUBLIC CONTRACTING.....	2
G. DEVIATIONS FROM THE INVITATION TO BID.....	3
H. SUBMISSION OF BID RESPONSES.....	3
I. BID PREPARATION COSTS.....	3
J. FAILURE TO COMPLY WITH INVITATION TO BID.....	3
K. BID CORRECTIONS.....	4
L. LATE BIDS.....	4
M. BID OPENING.....	4
N. INVITATION TO BID REQUIREMENTS.....	4
O. EVALUATION OF BIDS.....	4
P. BEST AND FINAL OFFER.....	5
Q. REFERENCE AND CREDIT CHECKS.....	5
R. AWARD.....	5
S. ALTERNATE/EQUIVALENT BIDS.....	5
T. BID TABULATIONS.....	6
U. REJECTION OF BIDS.....	6
V. RESIDENT BIDDER.....	6
II. TERMS AND CONDITIONS.....	7
A. GENERAL.....	7
B. NOTIFICATION.....	8
C. GOVERNING LAW (Statutory).....	8
D. AMENDMENT.....	8
E. CHANGE ORDERS OR SUBSTITUTIONS.....	8
F. NOTICE OF POTENTIAL CONTRACTOR BREACH.....	9
G. BREACH.....	9
H. NON-WAIVER OF BREACH.....	10
I. SEVERABILITY.....	10
J. INDEMNIFICATION.....	10
K. ATTORNEY'S FEES.....	11
L. ASSIGNMENT, SALE, OR MERGER.....	11
M. CONTRACTING WITH OTHER POLITICAL SUB-DIVISIONS OF THE STATE OR ANOTHER STATE.....	11
N. FORCE MAJEURE.....	11
O. CONFIDENTIALITY.....	12
P. EARLY TERMINATION.....	12
Q. CONTRACT CLOSEOUT.....	13
III. CONTRACTOR DUTIES.....	14
A. INDEPENDENT CONTRACTOR / OBLIGATIONS.....	14
B. EMPLOYEE WORK ELIGIBILITY STATUS.....	14
C. COMPLIANCE WITH CIVIL RIGHTS LAWS AND EQUAL OPPORTUNITY EMPLOYMENT / NONDISCRIMINATION (Statutory).....	15
D. COOPERATION WITH OTHER CONTRACTORS.....	15
E. DISCOUNTS.....	15
F. PRICES.....	15
G. COST CLARIFICATION.....	16
H. PERMITS, REGULATIONS, LAWS.....	16
I. NOTICE OF POTENTIAL CONTRACTOR BREACH.....	16

J.	ANTITRUST.....	16
K.	CONFLICT OF INTEREST	17
L.	ADVERTISING	17
M.	DISASTER RECOVERY/BACK UP PLAN.....	17
N.	DRUG POLICY	17
O.	WARRANTY	18
IV.	PAYMENT	19
A.	PROHIBITION AGAINST ADVANCE PAYMENT (Statutory).....	19
B.	TAXES (Statutory)	19
C.	INVOICES.....	19
D.	INSPECTION AND APPROVAL	19
E.	PAYMENT (Statutory).....	19
F.	LATE PAYMENT (Statutory).....	19
G.	SUBJECT TO FUNDING / FUNDING OUT CLAUSE FOR LOSS OF APPROPRIATIONS (Statutory).....	19
H.	RIGHT TO AUDIT (First Paragraph is Statutory)	19
V.	SCOPE OF WORK	21
A.	SCOPE	21
VI.	TECHNICAL SPECIFICATIONS	22
A.	CONTRACTOR INSTRUCTIONS.....	22
B.	NON-COMPLIANCE STATEMENT	22
C.	GENERAL SPECIFICATIONS.....	22
D.	MANUALS	23
E.	MISCELLANEOUS	23
F.	SOLAR POWER	24
G.	30 X 60 INCH.....	24
H.	WIRELESS REMOTE	24
I.	POWER TILT.....	25
J.	ANNUAL USAGE, ESTIMATED	25
K.	USAGE REPORT	25
L.	DELIVERY ARO	26
M.	DELIVERY LOCATIONS / INSTRUCTIONS (CONTRACTOR AGREES THAT THEY CAN MEET THE DELIVERY LOCATIONS/INSTRUCTIONS)	26
N.	ORDERS	26
O.	QUALITY	26
	Form A Contractor Contact Sheet.....	28

GLOSSARY OF TERMS

Acceptance Test Procedure: Benchmarks and other performance criteria, developed by the State or other sources of testing standards, for measuring the effectiveness of products or goods and the means used for testing such performance

Addendum: Something to be added or deleted to an existing document; a supplement

After Receipt of Order (ARO): After Receipt of Order

Agency: Using agencies shall mean and include all officers of the state, departments, bureaus, boards, commissions, councils, and institutions receiving legislative appropriations

Agent/Representative: A person authorized to act on behalf of another

Amend: To alter or change by adding, subtracting, or substituting

Amendment: A written correction or alteration to a document

Appropriation: Legislative authorization to expend public funds for a specific purpose. Money set apart for a specific use

Automated Clearing House (ACH): Electronic network for financial transactions in the United States

Award: All purchases, leases, or contracts which are based on competitive bids will be awarded according to the provisions in the solicitation

Best and Final Offer (BAFO): In a competitive bid, the final offer submitted which contains contractor's most favorable terms for price

Bid: An offer, proposal, or quote submitted by a contractor in a response to a written solicitation

Bid Bond: An insurance agreement, accompanied by a monetary commitment, by which a third party (the surety) accepts liability and guarantees that the contractor will not withdraw the proposal

Bidder: A contractor who submits an offer bid response to a written solicitation

Breach: Violation of a contractual obligation by failing to perform or repudiation of one's own promise.

Business: Any corporation, partnership, individual, sole proprietorship, joint-stock company, joint venture, or any other private legal entity

Business Day: Any weekday, except State-recognized holidays

Calendar Day: Every day shown on the calendar including Saturdays, Sundays, and State/Federal holidays

Cancellation: To call off or revoke a bid, purchase order or contract without expectation of conducting or performing at a later time

Catalog/Non-Core: A printed or electronic list of products a contractor may provide at a discounted rate or discount off list price to the State. Initial contract award(s) is not based on Catalog/Non-Core items

Central Processing Unit (CPU): Any computer or computer system that is used by the State to store, process, or retrieve data or perform other functions using Operating Systems and applications software

Change Order: Document that provides amendments to an executed purchase order

Collusion: An agreement or cooperation between two or more persons or entities to accomplish a fraudulent, deceitful, or unlawful purpose

Commodities: Any equipment, material, supply or goods; anything movable or tangible that is provided or sold

Commodities Description: Detailed descriptions of the items to be purchased; may include information necessary to obtain the desired quality, type, color, size, shape, or special characteristics necessary to perform the work intended to produce the desired results

Competition: The effort or action of two or more commercial interests to obtain the same business from third parties

Confidential Information: Unless otherwise defined below, "Confidential Information" shall also mean proprietary trade secrets, academic and scientific research work which is in progress and unpublished, and other information which if released would give advantage to business competitors and serve no public purpose (see Neb. Rev. Stat. §84-712.05(3)). In accordance with Nebraska

Attorney General Opinions 92068 and 97033, proof that information is proprietary requires identification of specific, named competitor(s) who would be advantaged by release of the information and the specific advantage the competitor(s) would receive

Contract: An agreement between two or more parties creating obligations that are enforceable or otherwise recognizable at law; the writing that sets forth such an agreement

Contract Administration: The management of the contract which includes and is not limited to contract signing, contract amendments and any necessary legal actions

Contract Management: The management of day to day activities at the agency which includes and is not limited to ensuring deliverables are received, specifications are met, handling meetings and making payments to the Contractor

Contract Period: The duration of the contract

Contractor: An individual or entity lawfully conducting business in the State, who seeks or agrees to provide goods or services under the terms of a written contract.

Contractor Performance Report: A report that documents good and poor performance. (See Supplier and Procurement Manual)

Cooperative Purchasing: The combining of requirements of two or more political entities to obtain advantages of volume purchases, reduction in administrative expenses or other public benefits

Copyright: A property right in an original work of authorship fixed in any tangible medium of expression, giving the holder the exclusive right to reproduce, adapt and distribute the work

Critical Program Error: Any Program Error, whether or not known to the State, which prohibits or significantly impairs use of the Licensed Software as set forth in the documentation and intended in the contract

Customer Service: The process of ensuring customer satisfaction by providing assistance and advice on those products or goods provided by a Contractor

Default: The omission or failure to perform a contractual duty

Deviation: Any proposed change(s) or alteration(s) to either the terms and conditions or deliverables within the scope of the written solicitation or contract

Evaluation: The process of examining an offer after opening to determine the contractor's responsibility, responsiveness to requirements, and to ascertain other characteristics of the offer that relate to determination of the successful award

Extension: Continuance of a contract for a specified duration upon the agreement of the parties beyond the original Contract Period. Not to be confused with "Renewal Period"

Free on Board (F.O.B.) Destination: The delivery charges are included in the quoted price and prepaid by the contractor. Contractor is responsible for all claims associated with damages during delivery of product

Free on Board (F.O.B.) Point of Origin: The delivery charges are not included in the quoted price and are the responsibility of the agency. Agency is responsible for all claims associated with damages during delivery of product

Foreign Corporation: A foreign corporation that was organized and chartered under the laws of another state, government, or country.

Installation Date: The date when the procedures described in "Installation by Contractor", and "Installation by State", as found in the solicitation, or contract are completed.

Interested Party: A person, acting in their personal capacity, or an entity entering into a contract or other agreement creating a legal interest therein

Invalid Bid: A bid response that does not meet the requirements of the solicitation or cannot be evaluated against the other bids.

Invitation to Bid (ITB): A written solicitation utilized for obtaining competitive offers for Services or Goods

Late Bid: An offer received after the Opening Date and Time

Licensed Software Documentation: The user manuals and any other materials in any form or medium customarily provided by the Contractor to the users of the Licensed Software which will provide the State with sufficient information to operate, diagnose, and maintain the Licensed Software properly, safely, and efficiently

Mandatory/Must: Required, compulsory, or obligatory

May: Discretionary, permitted; used to express possibility

Module (see System): A collection of routines and data structures that perform a specific function of software

Must: See Mandatory/Must and Shall/Will/Must

National Institute for Governmental Purchasing (NIGP): National Institute of Governmental Purchasing – Source used for assignment of universal commodity codes to goods and services

Non-core: See Catalog.

Offer: See Bid

Open Market Purchase: Authorization may be given to an agency to purchase items above direct purchase authority due to the unique nature, price, quantity, location of the using agency, or time limitations by the AS Materiel Division, State Purchasing Bureau

Opening Date and Time: Specified date and time for the public opening of received, labeled, and sealed formal bid responses

Operating System: The control program in a computer that provides the interface to the computer hardware and peripheral devices, and the usage and allocation of memory resources, processor resources, input/output resources, and security resources

Outsourcing: The contracting out of a business process which an organization may have previously performed internally or has a new need for, to an independent organization from which the process is purchased back

Payroll & Financial Center (PFC): Electronic procurement system of record

Performance Bond: An insurance agreement, accompanied by a monetary commitment, by which a third party (the surety) accepts liability and guarantees that the Contractor fulfills any and all obligations under the contract

Platform: A specific hardware and Operating System combination that is different from other hardware and Operating System combinations to the extent that a different version of the Licensed Software product is required to execute properly in the environment established by such hardware and Operating System combination

Point of Contact (POC): The person designated to receive communications and to communicate

Product: Something that is distributed commercially for use or consumption and that is usually (1) tangible personal property, (2) the result of fabrication or processing, and (3) an item that has passed through a chain of commercial distribution before ultimate use or consumption

Program Error: Code in Licensed Software which produces unintended results or actions, or which produces results or actions other than those described in the specifications. A program error includes, without limitation, any Critical Program Error

Program Set: The group of programs and products, including the Licensed Software specified in the solicitation, plus any additional programs and products licensed by the State under the contract for use by the State

Project: The total scheme, program, or method worked out for the accomplishment of an objective, including all documentation, commodities, and goods to be provided under the contract

Proposal: See Bid

Proprietary Information: Proprietary information is defined as trade secrets, academic and scientific research work which is in progress and unpublished, and other information which if released would give advantage to business competitors and service no public purpose (see Neb. Rev. Stat. § 84-712.05(3)). In accordance with Attorney General Opinions 92068 and 97033, proof that information is proprietary requires identification of specific named competitor(s) advantaged by release of the information and the demonstrated advantage the named competitor(s) would gain by the release of information

Protest/Grievance: A complaint about a governmental action or decision related to the solicitation or resultant contract, brought by a contractor who has timely submitted a bid response in connection with the award in question, to AS Materiel Division or another designated agency with the intention of achieving a remedial result

Public Bid Opening: The process of opening correctly submitted offers at the time and place specified in the written solicitation and in the presence of anyone who wished to attend

Quote: See Bid

Recommended Hardware Configuration: The data processing hardware (including all terminals, auxiliary storage, communication, and other peripheral devices) to the extent utilized by the State as recommended by the Contractor.

Release Date: The date of public release of the written solicitation to seek offers

Renewal Period: Optional contract periods subsequent to the original Contract Period for a specified duration with previously agreed to terms and conditions. Not to be confused with Extension

Request for Information (RFI): A general invitation to contractor is requesting information for a potential future solicitation. The RFI is typically used as a research and information gathering tool for preparation of a solicitation

Responsible Contractor: A Contractor who has the capability in all respects to perform fully and lawfully all requirements with integrity and reliability to assure good faith performance

Responsive Contractor: A Contractor who has submitted a bid response which conforms to all requirements of the solicitation document

Shall: See Must

Should: Expected; suggested, but not necessarily mandatory

Software License: Legal instrument with or without printed material that governs the use or redistribution of licensed software

Sole Source – Commodity: When an item is available from only one source due to the unique nature of the requirement, its contractor, or market conditions

Sole Source – Service: A service of such a unique nature that the contractor selected is clearly and justifiably the only practical source to provide the service. Determination that the contractor selected is justifiably the sole source is based on either the uniqueness of the service or sole availability at the location required

Specifications: The detailed statement, especially of the measurements, quality, materials, and functional characteristics, or other items to be provided under a contract

Statutory: These clauses are controlled by state law and are not subject to negotiation

Subcontractor: Individual or entity with whom the contractor enters a contract to perform a portion of the work awarded to the contractor

System (see Module): Any collection or aggregation of two (2) or more Modules that is designed to function, or is represented by the Contractor as functioning or being capable of functioning, as an entity

Termination: Occurs when the contract expires or either party, pursuant to a power created by agreement or law puts an end to the contract prior to the stated expiration date. All obligations which are still executory on both sides are discharged but any right based on prior breach or performance survives

Third-Party: Any person or entity, including but not limited to fiduciaries, shareholders, owners, officers, managers, employees, legally disinterested persons, and sub-contractors or agents, and their employees. It shall not include any entity or person who is an interested Party to the contract or agreement

Trade Secret: Information, including, but not limited to, a drawing, formula, pattern, compilation, program, device, method, technique, code, or process that (a) derives independent economic value, actual or potential, from not being known to, and not being ascertainable by proper means by, other persons who can obtain economic value from its disclosure or use; and (b) is the subject of efforts that are reasonable under the circumstances to maintain its secrecy (see Neb. Rev. Stat. § 87-502(4))

Trademark: A word, phrase, logo, or other graphic symbol used by a manufacturer or contractor to distinguish its product from those of others, registered with the U.S. Patent and Trademark Office

Upgrade: Any change that improves or alters the basic function of a product of service

Will: See Mandatory/Must/Shall

Work Day: See Business Day

ACRONYM LIST

ARO – After Receipt of Order

ACH – Automated Clearing House

BAFO – Best and Final Offer

COI – Certificate of Insurance

CPU – Central Processing Unit

DAS – Department of Administrative Services

F.O.B. – Free on Board

ITB – Invitation to Bid

NIGP – National Institute for Governmental Purchasing

PA – Participating Addendum

RFI – Request for Information

RFP – Request for Proposal

SPB – State Purchasing Bureau

I. PROCUREMENT PROCEDURE

A. GENERAL INFORMATION

The solicitation is designed to solicit bids from qualified Contractors who will be responsible for providing Truck Mounted Sequential Flashing Arrow Board at a competitive and reasonable cost. Terms and Conditions, Project Description and Scope of Work, Bid instructions, and Cost Bid Requirements may be found in Sections II through VI.

Bid responses shall conform to all instructions, conditions, and requirements included in the solicitation. Prospective Contractors are expected to carefully examine all documents, schedules, and requirements in this solicitation, and respond to each requirement in the format prescribed. Bids may be found non-responsive if they do not conform to the solicitation.

B. PROCURING OFFICE AND COMMUNICATION WITH STATE STAFF AND EVALUATORS

Procurement responsibilities related to this solicitation reside with SPB. The point of contact (POC) for the procurement is as follows:

Name: René A. Botts
Agency: State Purchasing Bureau
Address: 1526 K Street, Suite 130
Lincoln, NE 68508

Telephone: 402-471-6500

E-Mail: as.materielpurchasing@nebraska.gov

From the date the solicitation is issued until the Intent to Award is issued, communication from the Contractor is limited to the POC listed above. After the Intent to Award is issued, the Contractor may communicate with individuals the State has designated as responsible for negotiating the contract on behalf of the State. No member of the State Government, employee of the State, or member of the Evaluation Committee is empowered to make binding statements regarding this solicitation. The POC will issue any answers, clarifications or amendments regarding this solicitation in writing. Only the SPB or awarding agency can award a contract. Contractors shall not have any communication with, or attempt to communicate or influence any evaluator involved in this solicitation.

The following exceptions to these restrictions are permitted:

1. Contact made pursuant to pre-existing contracts or obligations;
2. Contact required by the schedule of events or an event scheduled later by POC; and
3. Contact required for negotiation and execution of the final contract.

The State reserves the right to reject a contractor's bid response, withdraw an Intent to Award, or terminate a contract if the State determines there has been a violation of these procurement procedures.

C. SCHEDULE OF EVENTS

The State expects to adhere to the procurement schedule shown below, but all dates are approximate and subject to change.

ACTIVITY		DATE/TIME
1.	Release solicitation	May 16, 2019
2.	Last day to submit written questions	June 4, 2019
3.	State responds to written questions through a solicitation "Addendum" and/or "Amendment" to be posted to the Internet at: http://das.nebraska.gov/materiel/purchasing.html	June 6, 2019
4.	Bid Opening Location: State Purchasing Bureau 1526 K Street, Suite 130 Lincoln, NE 68508	June 18, 2019 2:00 PM Central Time
5.	Review for conformance with bid requirements	TBA
6.	Evaluation period	TBA
7.	Post "Notification of Intent to Award" to Internet at: http://das.nebraska.gov/materiel/purchasing.html	TBA
8.	Contract finalization period	TBA
9.	Contract award	TBA

D. WRITTEN QUESTIONS AND ANSWERS

Questions regarding the meaning or interpretation of any solicitation provision must be submitted in writing to SPB and clearly marked "ITB Number 6093 OF; Truck Mounted Sequential Flashing Arrow Board Questions". POC is not obligated to respond to questions that are received late per the Schedule of Events.

Contractors should present, as questions, any assumptions upon which the Contractor's bid response is or might be developed. Bid responses will be evaluated without consideration of any known or unknown assumptions of a Contractor. The contract will not incorporate any known or unknown assumptions of a Contractor.

It is preferred that questions be sent via e-mail to as.materielpurchasing@nebraska.gov, but may be delivered by hand or by U.S. Mail. It is recommended that Contractors submit questions using the following format.

ITB Section Reference	ITB Page Number	Question

Written answers will be posted at <http://das.nebraska.gov/materiel/purchasing.html> per the Schedule of Events.

E. SECRETARY OF STATE/TAX COMMISSIONER REGISTRATION REQUIREMENTS (Statutory)

All Contractors must be authorized to transact business in the State and comply with all Nebraska Secretary of State Registration requirements. The Contractor who is the recipient of an Intent to Award will be required to certify that it has complied and produce a true and correct copy of its current (within ninety (90) calendar days of the intent to award) Certificate or Letter of Good Standing, or in the case of a sole proprietorship, provide written documentation of sole proprietorship and the United States Citizenship Attestation Form, available on the DAS website at: <http://das.nebraska.gov/materiel/purchasing.html>. This must be accomplished prior to execution of the contract.

F. ETHICS IN PUBLIC CONTRACTING

The State reserves the right to reject bid responses, withdraw an intent to award or award, or terminate a contract if a Contractor commits or has committed ethical violations, which include, but are not limited to:

1. Offering or giving, directly or indirectly, a bribe, fee, commission, compensation, gift, gratuity, or anything of value to any person or entity in an attempt to influence the bidding process;
2. Utilize the services of lobbyists, attorneys, political activists, or consultants to influence or subvert the bidding process;
3. Being considered for, presently being, or becoming debarred, suspended, ineligible, or excluded from contracting with any state or federal entity;
4. Submitting a bid response on behalf of another party or entity;

5. Collude with any person or entity to influence the bidding process, submit sham bid responses, preclude bidding, fix pricing or costs, create an unfair advantage, subvert the bid, or prejudice the State.

The Contractor shall include this clause in any subcontract entered into for the exclusive purpose of performing this contract.

Contractor shall have an affirmative duty to report any violations of this clause by the Contractor throughout the bidding process, and throughout the term of this contract for the successful Contractor and their subcontractors.

G. DEVIATIONS FROM THE INVITATION TO BID

The requirements contained in the solicitation (Sections II through VI) become a part of the terms and conditions of the contract resulting from this solicitation. Any deviations from the solicitation in Sections II through VI must be clearly defined by the Contractor in its bid response and, if accepted by the State, will become part of the contract. Any specifically defined deviations must not be in conflict with the basic nature of the solicitation, solicitation requirements, or applicable state or federal laws or statutes. "Deviation", for the purposes of this solicitation, means any proposed changes or alterations to either the contractual language or deliverables within the scope of this solicitation. The State discourages deviations and reserves the right to reject proposed deviations.

H. SUBMISSION OF BID RESPONSES

*****ALL BID RESPONSES MUST BE SUBMITTED IN A SEALED ENVELOPE OR CONTAINER!*****

Contractors should submit one bid response marked on the first page: "ORIGINAL". If multiple bid responses are submitted, the State will retain one copy marked "ORIGINAL" and destroy the other copies. The Contractor is solely responsible for any variance between the copies submitted. Bid responses should include the completed Form A, "Contractor Bid Response Point of Contact". Bid responses must reference the ITB number and be sent to the specified address. Please note that the address label should appear as specified in Section I B. on the face of each container or contractor's bid response packet. If a recipient phone number is required for delivery purposes, 402-471-6500 should be used. The ITB number should be included in all correspondence. The State will not furnish packaging and sealing materials. It is the contractor's responsibility to ensure the ITB is received in a sealed envelope or container and submitted by the date and time indicated in the Schedule of Events. Sealed proposals must be received in the State Purchasing Bureau by the date and time of the bid opening per the Schedule of Events. No late bids will be accepted.

The Invitation to Bid form must be manually signed in an indelible manner and returned by the bid opening date and time along with the contractor's Invitation to Bid along with any other requirements as stated in the Invitation to Bid document in order for the contractor's Invitation to Bid response to be evaluated.

It is the responsibility of the contractor to check the website for all information relevant to this Invitation to Bid to include addenda and/or amendments issued prior to the opening date. Website address is as follows:
<http://das.nebraska.gov/materiel/purchasing.html>

Emphasis should be concentrated on conformance to the ITB instructions, responsiveness to requirements, completeness, and clarity of content. If the contractor's bid is presented in such a fashion that makes evaluation difficult or overly time consuming the State reserves the right to reject the bid as non-conforming.

By signing the Invitation to Bid, the contractor guarantees compliance with the provisions stated in this ITB.

The State shall not incur any liability for any costs incurred by contractors in replying to this ITB, in the demonstrations and/or oral presentations, or in any other activity related to bidding on this ITB.

I. BID PREPARATION COSTS

The State shall not incur any liability for any costs incurred by Contractors in replying to this solicitation, including any activity related to bidding on this solicitation.

J. FAILURE TO COMPLY WITH INVITATION TO BID

Violation of the terms and conditions contained in this solicitation or any resultant contract, at any time before or after the award, shall be grounds for action by the State which may include, but is not limited to, the following:

1. Rejection of a Contractor's bid;
2. Withdrawal of the Intent to Award;
3. Withdrawal of the Award;
4. Termination of the resulting contract;
5. Legal action; or,

6. Suspension of the Contractor from further bidding with the State for the period of time relative to the seriousness of the violation, such period to be within the sole discretion of the State.

K. BID CORRECTIONS

A contractor may correct a mistake in a bid prior to the time of opening by giving written notice to the State of intent to withdraw the bid for modification or to withdraw the bid completely. Changing a bid after opening may be permitted if the change is made to correct a minor error that does not affect price, quantity, quality, delivery, or contractual conditions. In case of a mathematical error in extension of price, unit price shall govern.

L. LATE BIDS

Bids received after the time and date of the bid opening will be considered late bids. Late bids will be returned unopened, if requested by the Contractor and at Contractor's expense. The State is not responsible for bids that are late or lost regardless of cause or fault.

M. BID OPENING

Anyone may attend the opening. It is considered a public opening. The Buyer will read the names of the respondents. Depending upon the complexity of the bid for goods, the buyer may read the bids aloud or allow bids be available for viewing by the public during the bid opening. Once the bid opening has concluded, the bids will not be available for viewing until the Intent to Award has been posted. An initial bid tabulation will be posted to the website as soon as feasible. Information identified as proprietary by the submitting contractor, in accordance with the solicitation and state statute, will not be posted. If the state determines submitted information should not be withheld, in accordance with the [Public Records Act](#), or if ordered to release any withheld information, said information may then be released. The submitting contractor will be notified of the release and it shall be the obligation of the submitting contractor to take further action, if it believes the information should not be released.

N. INVITATION TO BID REQUIREMENTS

The bids will first be examined to determine if all requirements listed below have been addressed and whether further evaluation is warranted. Bid responses not meeting the requirements may be rejected as non-responsive. The requirements are:

1. Original Commodity ITB form signed using an indelible method (electronic signatures are acceptable);
2. Clarity and responsiveness of the bid;
3. Completed Sections II through VI;
4. Completed ITB Form or State's Cost Sheet.

O. EVALUATION OF BIDS

All bids that are responsive to the solicitation will be evaluated based on the following:

1. Cost Proposal

Neb. Rev. Stat. §73-107 allows for a preference for a resident disabled veteran or business located in a designated enterprise zone. When a state contract is to be awarded to the lowest responsible contractor, a resident disabled veteran or a business located in a designated enterprise zone under the Enterprise Zone Act shall be allowed a preference over any other resident or nonresident contractor, if all other factors are equal.

Resident disabled veterans means any person (a) who resides in the State of Nebraska, who served in the United States Armed Forces, including any reserve component or the National Guard, who was discharged or otherwise separated with a characterization of honorable or general (under honorable conditions), and who possesses a disability rating letter issued by the United States Department of Veterans Affairs establishing a service-connected disability or a disability determination from the United States Department of Defense and (b)(i) who owns and controls a business or, in the case of a publicly owned business, more than fifty percent of the stock is owned by one or more persons described in subdivision (a) of this subsection and (ii) the management and daily business operations of the business are controlled by one or more persons described in subdivision(a) of this subsection. Any contract entered into without compliance with this section shall be null and void.

Therefore, if a resident disabled veteran or business located in a designated enterprise zone submits a bid in accordance with Neb. Rev. Stat. §73-107 and has so indicated on the ITB cover page under "Contractor must complete the following" requesting priority/preference to be considered in the award of this contract, the following will need to be submitted by the contractor within ten (10) business days of request:

1. Documentation from the United States Armed Forces confirming service;
2. Documentation of discharge or otherwise separated characterization of honorable or general (under honorable conditions);

3. Disability rating letter issued by the United States Department of Veterans Affairs establishing a service-connected disability or a disability determination from the United States Department of Defense; and
4. Documentation which shows ownership and control of a business or, in the case of a publicly owned business, more than fifty percent of the stock is owned by one or more persons described in subdivision (a) of this subsection; and the management and daily business operations of the business are controlled by one or more persons described in subdivision (a) of this subsection.

Failure to submit the requested documentation within ten (10) business days of notice will disqualify the contractor from consideration of the preference.

P. BEST AND FINAL OFFER

If best and final offers (BAFO) are requested by the State and submitted by the contractor, they will be evaluated (using the stated BAFO criteria) and ranked by the Evaluation Committee. The State reserves the right to conduct more than one BAFO. The award will then be granted to the lowest responsible contractor. However, a contractor should provide its best offer in its original bid. Contractors should not expect that the State will request a BAFO.

Q. REFERENCE AND CREDIT CHECKS

The State reserves the right to conduct and consider reference and credit checks. The State reserves the right to use third parties to conduct reference and credit checks. By submitting a bid in response to this solicitation, the contractor grants to the State the right to contact or arrange a visit in person with any or all of the contractor's clients. Reference and credit checks may be grounds to reject a bid, withdraw an intent to award, or rescind the award of a contract.

R. AWARD

The State reserves the right to evaluate bids and award contracts in a manner utilizing criteria selected at the State's discretion and in the State's best interest. After evaluation of the bids, or at any point in the solicitation process, the State of Nebraska may take one or more of the following actions:

1. Amend the solicitation;
2. Extend the time of or establish a new bid opening time;
3. Waive deviations or errors in the State's solicitation process and in contractor bids that are not material, do not compromise the solicitation process or a contractor's bid, and do not improve a contractor's competitive position;
4. Accept or reject a portion of or all of a bid;
5. Accept or reject all bids;
6. Withdraw the solicitation;
7. Elect to rebid the solicitation;
8. Award single lines or multiple lines to one or more contractors; or,
9. Award one or more all-inclusive contracts.

The State of Nebraska may consider, but is not limited to considering, one or more of the following award criteria:

1. Price;
2. Location;
3. Quality;
4. Delivery time;
5. Contractor qualifications and capabilities;
6. State contract management requirements and/or costs; and,

The solicitation does not commit the State to award a contract. Once intent to award decision has been determined, it will be posted to the Internet at:

<http://das.nebraska.gov/materiel/purchasing.html>

Any protests must be filed by a contractor within ten (10) business days after the intent to award decision is posted to the Internet. Grievance and protest procedure is available on the Internet at:

<http://das.nebraska.gov/materiel/purchasing.html>

S. ALTERNATE/EQUIVALENT BIDS

Contractor may offer bids which are at variance from the express specifications of the solicitation. The State reserves the right to consider and accept such bids if, in the judgment of the Materiel Administrator, the bid will result in goods and/or services equivalent to or better than those which would be supplied in the original bid specifications. Contractor must indicate on the solicitation the manufacturer's name, number and shall submit with their bid, sketches, descriptive literature and/or complete specifications. Reference to literature submitted with a previous bid will not satisfy this provision. Bids which do not comply with these requirements are subject to rejection. In the absence of

any stated deviation or exception, the bid will be accepted as in strict compliance with all terms, conditions and specification, and the Contractor shall be held liable therefore.

T. BID TABULATIONS

Bid tabulations are available on the website at: <http://www.das.state.ne.us/materiel/purchasing/bidtabs.htm>.

U. REJECTION OF BIDS

The State reserves the right to reject any or all bids, wholly or in part, in the best interest of the State.

V. RESIDENT BIDDER

Pursuant to Neb. Rev. Stat. §§ 73-101.01 through 73-101.02, a Resident Bidder shall be allowed a preference against a Non-resident Bidder from a state which gives or requires a preference to Bidders from that state. The preference shall be equal to the preference given or required by the state of the Nonresident Bidders. Where the lowest responsible bid from a resident Bidder is equal in all respects to one from a nonresident Bidder from a state which has no preference law, the resident Bidder shall be awarded the contract. The provision of this preference shall not apply to any contract for any project upon which federal funds would be withheld because of the provisions of this preference.

II. TERMS AND CONDITIONS

Contractors should complete Section II through VI as part of their bid response. Contractor is expected to read the Terms and Conditions and must initial either accept, reject, or reject and provide alternative language for each clause. The Contractor should also provide an explanation of why the Contractor rejected the clause or rejected the clause and provided alternate language using "Track Changes". Upon request an electronic copy of the bid with "Track Changes" must be submitted in an editable Word format. By signing the solicitation, Contractor is agreeing to be legally bound by all the accepted terms and conditions, and any proposed alternative terms and conditions submitted with the bid. The State reserves the right to negotiate rejected or proposed alternative language. If the State and Contractor fail to agree on the final Terms and Conditions, the State reserves the right to reject the bid. The State is soliciting bids in response to the solicitation. The State reserves the right to reject bids that attempt to substitute the Contractor's commercial contracts and/or documents for this solicitation.

The Contractor should submit with their bid any license, user agreement, service level agreement, or similar documents that the Contractor wants incorporated in the Contract. Upon notice of Intent to Award, the Contractor must submit a copy of these documents in an editable Word format. The State will not consider incorporation of any document not submitted with the Contractor's bid response. These documents shall be subject to negotiation and will be incorporated as addendums if agreed to by the Parties.

If a conflict or ambiguity arises after the addendums have been negotiated and agreed to, the addendums shall be interpreted as follows:

1. If only one (1) Party's document has a particular clause then that clause shall control;
2. If both Party's documents have a similar clause, but the clauses do not conflict, the clauses shall be read together;
3. If both Party's documents have a similar clause, but the clauses conflict, the State's clause shall control.

A. GENERAL

Accept (Initial)	Reject (Initial)	Reject & Provide Alternative within Solicitation Response (Initial)	NOTES/COMMENTS:
AB			

The contract resulting from this solicitation shall incorporate the following documents:

1. Invitation to Bid and Addenda;
2. Amendments to the solicitation;
3. Questions and Answers;
4. Contractor's bid response;
5. The executed Contract and any Addenda, if applicable, and properly submitted documents; and,
6. Amendments to the Contract

These documents constitute the entirety of the contract.

Unless otherwise specifically stated in a future contract amendment, in case of any conflict between the incorporated documents, the documents shall govern in the following order of preference with number one (1) receiving preference over all other documents and with each lower numbered document having preference over any higher numbered document: 1) Amendment to the executed Contract with the most recent dated amendment having the highest priority, 2) executed Contract and any attached Addenda, 3) Amendments to solicitation and any Questions and Answers, 4) the original solicitation document and any Addenda, and 5) the Contractor's submitted Bid.

Any ambiguity or conflict in the contract discovered after its execution, not otherwise addressed herein, shall be resolved in accordance with the rules of contract interpretation as established in the State.

B. NOTIFICATION

Accept (Initial)	Reject (Initial)	Reject & Provide Alternative within Solicitation Response (Initial)	NOTES/COMMENTS:
AB			

Contractor and State shall identify the contract manager who shall serve as the point of contact for the executed contract.

Communications regarding the executed contract shall be in writing and shall be deemed to have been given if delivered personally or mailed, by U.S. Mail, postage prepaid, return receipt requested, to the parties at their respective addresses set forth in the resulting contract, or at such other addresses as may be specified in writing by either of the parties. All notices, requests, or communications shall be deemed effective upon personal delivery or five (5) calendar days following deposit in the mail.

Either party may change its address for notification purposes by giving notice of the change, and setting forth the new address and an effective date.

C. GOVERNING LAW (Statutory)

Notwithstanding any other provision of this contract, or any amendment or addendum(s) entered into contemporaneously or at a later time, the parties understand and agree that, (1) the State of Nebraska is a sovereign state and its authority to contract is therefore subject to limitation by the State's Constitution, statutes, common law, and regulation; (2) this contract will be interpreted and enforced under the laws of the State of Nebraska; (3) any action to enforce the provisions of this contract must be brought in the State of Nebraska per state law; (4) the person signing this contract on behalf of the State of Nebraska does not have the authority to waive the State's sovereign immunity, statutes, common law, or regulations; (5) the indemnity, limitation of liability, remedy, and other similar provisions of the final contract, if any, are entered into subject to the State's Constitution, statutes, common law, regulations, and sovereign immunity; and, (6) all terms and conditions of the final contract, including but not limited to the clauses concerning third-party use, licenses, warranties, limitations of liability, governing law and venue, usage verification, indemnity, liability, remedy or other similar provisions of the final contract are entered into specifically subject to the State's Constitution, statutes, common law, regulations, and sovereign immunity.

The Parties must comply with all applicable local, state and federal laws, ordinances, rules, orders, and regulations.

D. AMENDMENT

This Contract may be amended in writing, within scope, upon the agreement of both parties.

E. CHANGE ORDERS OR SUBSTITUTIONS

Accept (Initial)	Reject (Initial)	Reject & Provide Alternative within Solicitation Response (Initial)	NOTES/COMMENTS:
AB			

The State and the Contractor, upon the written agreement, may make changes to the contract within the general scope of the solicitation. Changes may involve specifications, the quantity of work, or such other items as the State may find necessary or desirable. Corrections of any deliverable, service, or work required pursuant to the contract shall not be deemed a change. The Contractor may not claim forfeiture of the contract by reasons of such changes.

The Contractor shall prepare a written description of the work required due to the change and an itemized cost sheet for the change. Changes in work and the amount of compensation to be paid to the Contractor shall be determined in accordance with applicable unit prices if any, a pro-rated value, or through negotiations. The State shall not incur a price increase for changes that should have been included in the Contractor's bid, were foreseeable, or result from difficulties with or failure of the Contractor's bid or performance.

No change shall be implemented by the Contractor until approved by the State, and the Contract is amended to reflect the change and associated costs, if any. If there is a dispute regarding the cost, but both parties agree that immediate implementation is necessary, the change may be implemented, and cost negotiations may continue with both Parties retaining all remedies under the contract and law.

In the event any product is discontinued or replaced upon mutual consent during the contract period or prior to delivery, the State reserves the right to amend the contract or purchase order to include the alternate product at the same price.

*****Contractor will not substitute any item that has been awarded without prior written approval of SPB*****

F. NOTICE OF POTENTIAL CONTRACTOR BREACH

Accept (Initial)	Reject (Initial)	Reject & Provide Alternative within Solicitation Response (Initial)	NOTES/COMMENTS:
SPB			

If Contractor breaches the contract or anticipates breaching the contract, the Contractor shall immediately give written notice to the State. The notice shall explain the breach or potential breach, a proposed cure, and may include a request for a waiver of the breach if so desired. The State may, in its discretion, temporarily or permanently waive the breach. By granting a waiver, the State does not forfeit any rights or remedies to which the State is entitled by law or equity, or pursuant to the provisions of the contract. Failure to give immediate notice, however, may be grounds for denial of any request for a waiver of a breach.

G. BREACH

Accept (Initial)	Reject (Initial)	Reject & Provide Alternative within Solicitation Response (Initial)	NOTES/COMMENTS:
SPB			

Either Party may terminate the contract, in whole or in part, if the other Party breaches its duty to perform its obligations under the contract in a timely and proper manner. Termination requires written notice of default and a thirty (30) calendar day (or longer at the non-breaching Party's discretion considering the gravity and nature of the default) cure period. Said notice shall be delivered by Certified Mail, Return Receipt Requested, or in person with proof of delivery. Allowing time to cure a failure or breach of contract does not waive the right to immediately terminate the contract for the same or different contract breach which may occur at a different time.

In case of breach by the Contractor, the State may, without unreasonable delay, make a good faith effort to make a reasonable purchase or contract to purchased goods in substitution of those due from the contractor. The State may recover from the Contractor as damages the difference between the costs of covering the breach. Notwithstanding any clause to the contrary, the State may also recover the contract price together with any incidental or consequential damages defined in UCC Section 2-715, but less expenses saved in consequence of Contractor's breach. OR In case of default of the Contractor, the State may contract the service from other sources and hold the Contractor responsible for any excess cost occasioned thereby.

The State's failure to make payment shall not be a breach, and the Contractor shall retain all available statutory remedies. (See Indemnity - Self-Insurance and Payment)

H. NON-WAIVER OF BREACH

Accept (Initial)	Reject (Initial)	Reject & Provide Alternative within Solicitation Response (Initial)	NOTES/COMMENTS:
AB			

The acceptance of late performance with or without objection or reservation by a Party shall not waive any rights of the Party nor constitute a waiver of the requirement of timely performance of any obligations remaining to be performed.

I. SEVERABILITY

Accept (Initial)	Reject (Initial)	Reject & Provide Alternative within Solicitation Response (Initial)	NOTES/COMMENTS:
AB			

If any term or condition of the contract is declared by a court of competent jurisdiction to be illegal or in conflict with any law, the validity of the remaining terms and conditions shall not be affected, and the rights and obligations of the parties shall be construed and enforced as if the contract did not contain the provision held to be invalid or illegal.

J. INDEMNIFICATION

Accept (Initial)	Reject (Initial)	Reject & Provide Alternative within Solicitation Response (Initial)	NOTES/COMMENTS:
AB			

1. GENERAL

The Contractor agrees to defend, indemnify, and hold harmless the State and its employees, volunteers, agents, and its elected and appointed officials ("the indemnified parties") from and against any and all claims, liens, demands, damages, liability, actions, causes of action, losses, judgments, costs, and expenses of every nature, including investigation costs and expenses, settlement costs, and attorney fees and expenses ("the claims"), sustained or asserted against the State for personal injury, death, or property loss or damage, arising out of, resulting from, or attributable to the willful misconduct, negligence, error, or omission of the Contractor, its employees, Subcontractors, consultants, representatives, and agents, resulting from this contract, except to the extent such Contractor liability is attenuated by any action of the State which directly and proximately contributed to the claims.

2. SELF-INSURANCE (Statutory)

The State is self-insured for any loss and purchases excess insurance coverage pursuant to Neb. Rev. Stat. § 81-8,239.01 (Reissue 2008). If there is a presumed loss under the provisions of this contract, Contractor may file a claim with the Office of Risk Management pursuant to Neb. Rev. Stat. §§ 81-8,829 through 81-8,306 for review by the State Claims Board. The State retains all rights and immunities under the State Miscellaneous (Section 81-8,294), Tort (Section 81-8,209), and Contract Claim Acts (Section 81-8,302), as outlined in Neb. Rev. Stat. § 81-8,209 et seq. and under any other provisions of law and accepts liability under this contract to the extent provided by law.

K. ATTORNEY'S FEES

Accept (Initial)	Reject (Initial)	Reject & Provide Alternative within Solicitation Response (Initial)	NOTES/COMMENTS:
AB			

In the event of any litigation, appeal, or other legal action to enforce any provision of the contract, the Parties agree to pay all expenses of such action, as permitted by law and if ordered by the court, including attorney's fees and costs, if the other party prevails.

L. ASSIGNMENT, SALE, OR MERGER

Accept (Initial)	Reject (Initial)	Reject & Provide Alternative within Solicitation Response (Initial)	NOTES/COMMENTS:
AB			

Either party may assign the contract upon mutual written agreement of the other party. Such agreement shall not be unreasonably withheld.

The Contractor retains the right to enter into a sale, merger, acquisition, internal reorganization, or similar transaction involving Contractor's business. Contractor agrees to cooperate with the State in executing amendments to the contract to allow for the transaction. If a third party or entity is involved in the transaction, the Contractor will remain responsible for performance of the contract until such time as the person or entity involved in the transaction agrees in writing to be contractually bound by this contract and perform all obligations of the contract.

M. CONTRACTING WITH OTHER POLITICAL SUB-DIVISIONS OF THE STATE OR ANOTHER STATE

Accept (Initial)	Reject (Initial)	Reject & Provide Alternative within Solicitation Response (Initial)	NOTES/COMMENTS:
AB			

The Contractor may, but shall not be required to, allow agencies, as defined in Neb. Rev. Stat. § 81-145, to use this contract. The terms and conditions, including price, of the contract may not be amended. The State shall not be contractually obligated or liable for any contract entered into pursuant to this clause.

The Contractor may, but shall not be required to, allow other states, agencies or divisions of other states, or political subdivisions of other states to use this contract. The terms and conditions, including price, of this contract shall apply to any such contract, but may be amended upon mutual consent of the Parties. The State of Nebraska shall not be contractually or otherwise obligated or liable under any contract entered into pursuant to this clause. The State shall be notified if a contract is executed based upon this contract.

N. FORCE MAJEURE

Accept (Initial)	Reject (Initial)	Reject & Provide Alternative within Solicitation Response (Initial)	NOTES/COMMENTS:
AB			

Neither party shall be liable for any costs or damages, or for default resulting from its inability to perform any of its obligations under the contract due to a natural or man-made event outside the control and not the fault of the affected party ("Force Majeure Event"). The Party so affected shall immediately make a written request for relief to the other party, and shall have the burden of proof to justify the request. The other Party may granted the relief requested; relief may not be unreasonably withheld. Labor disputes with the impacted party's own employees will not be considered a Force Majeure Event.

O. CONFIDENTIALITY

Accept (Initial)	Reject (Initial)	Reject & Provide Alternative within Solicitation Response (Initial)	NOTES/COMMENTS:
AB			

All materials and information provided by the Parties or acquired by a Party on behalf of the other Party shall be regarded as confidential information. All materials and information provided or acquired shall be handled in accordance with federal and state law, and ethical standards. Should said confidentiality be breached by a Party, the Party shall notify the other Party immediately of said breach and take immediate corrective action.

It is incumbent upon the Parties to inform their officers and employees of the penalties for improper disclosure imposed by the Privacy Act of 1974, 5 U.S.C. 552a. Specifically, 5 U.S.C. 552a (i)(1), which is made applicable by 5 U.S.C. 552a (m)(1), provides that any officer or employee, who by virtue of his/her employment or official position has possession of or access to agency records which contain individually identifiable information, the disclosure of which is prohibited by the Privacy Act or regulations established thereunder, and who knowing that disclosure of the specific material is prohibited, willfully discloses the material in any manner to any person or agency not entitled to receive it, shall be guilty of a misdemeanor and fined not more than \$5,000.

P. EARLY TERMINATION

Accept (Initial)	Reject (Initial)	Reject & Provide Alternative within Solicitation Response (Initial)	NOTES/COMMENTS:
AB			

The contract may be terminated as follows:

1. The State and the Contractor, by mutual written agreement, may terminate the contract at any time.
2. The State, at its sole discretion, may terminate the contract for any reason upon thirty (30) calendar day's written notice to the Contractor. Such termination shall not relieve the Contractor of warranty or other service obligations incurred under the terms of the contract. In the event of termination the Contractor shall be entitled to payment, determined on a pro rata basis, for products or services satisfactorily performed or provided.
3. The State may terminate the contract immediately for the following reasons:
 - a. if directed to do so by statute;
 - b. Contractor has made an assignment for the benefit of creditors, has admitted in writing its inability to pay debts as they mature, or has ceased operating in the normal course of business;
 - c. a trustee or receiver of the Contractor or of any substantial part of the Contractor's assets has been appointed by a court;
 - d. fraud, misappropriation, embezzlement, malfeasance, misfeasance, or illegal conduct pertaining to performance under the contract by its Contractor, its employees, officers, directors, or shareholders;
 - e. an involuntary proceeding has been commenced by any party against the Contractor under any one of the chapters of Title 11 of the United States Code and (i) the proceeding has been pending for at least sixty (60) calendar days; or (ii) the Contractor has consented, either expressly or by operation of law, to the entry of an order for relief; or (iii) the Contractor has been decreed or adjudged a debtor;

- f. a voluntary petition has been filed by the Contractor under any of the chapters of Title 11 of the United States Code;
- g. Contractor intentionally discloses confidential information;
- h. Contractor has or announces it will discontinue support of the deliverable; and,
- i. In the event funding is no longer available.

Q. CONTRACT CLOSEOUT

Accept (Initial)	Reject (Initial)	Reject & Provide Alternative within Solicitation Response (Initial)	NOTES/COMMENTS:
AB			

Upon termination of the contract for any reason the Contractor shall within thirty (30) days, unless stated otherwise herein:

1. Transfer all completed or partially completed deliverables to the State;
2. Transfer ownership and title to all completed or partially completed deliverables to the State;
3. Return to the State all information and data, unless the Contractor is permitted to keep the information or data by contract or rule of law. Contractor may retain one copy of any information or data as required to comply with applicable work product documentation standards or as are automatically retained in the course of Contractor's routine back up procedures;
4. Cooperate with any successor contractor, person or entity in the assumption of any or all of the obligations of this contract;
5. Cooperate with any successor contractor, person or entity with the transfer of information or data related to this contract;
6. Return or vacate any state owned real or personal property; and,
7. Return all data in a mutually acceptable format and manner.

Nothing in this Section should be construed to require the Contractor to surrender intellectual property, real or person property, or information or data owned by the Contractor for which the State has no legal claim.

III. CONTRACTOR DUTIES

A. INDEPENDENT CONTRACTOR / OBLIGATIONS

Accept (Initial)	Reject (Initial)	Reject & Provide Alternative within Solicitation Response (Initial)	NOTES/COMMENTS:
AB			

It is agreed that the Contractor is an independent contractor and that nothing contained herein is intended or should be construed as creating or establishing a relationship of employment, agency, or a partnership.

The Contractor is solely responsible for fulfilling the contract. The Contractor or the Contractor's representative shall be the sole point of contact regarding all contractual matters.

The Contractor shall secure, at its own expense, all personnel required to perform the services under the contract. The personnel the Contractor uses to fulfill the contract shall have no contractual or other legal relationship with the State; they shall not be considered employees of the State and shall not be entitled to any compensation, rights or benefits from the State, including but not limited to, tenure rights, medical and hospital care, sick and vacation leave, severance pay, or retirement benefits.

By-name personnel commitments made in the Contractor's bid shall not be changed without the prior written approval of the State. Replacement of these personnel, if approved by the State, shall be with personnel of equal or greater ability and qualifications.

The Contractor warrants that all persons assigned to the project shall be employees of the Contractor or a Subcontractor, and shall be fully qualified to perform the work required herein. Personnel employed by the Contractor or a subcontractor to fulfill the terms of the contract shall remain under the sole direction and control of the Contractor or the subcontractor respectively.

With respect to its employees, the Contractor agrees to be solely responsible for the following:

1. Any and all pay, benefits, and employment taxes and/or other payroll withholding;
2. Any and all vehicles used by the Contractor's employees, including all insurance required by state law;
3. Damages incurred by Contractor's employees within the scope of their duties under the contract;
4. Maintaining Workers' Compensation and health insurance that complies with state and federal law and submitting any reports on such insurance to the extent required by governing law;
5. Determining the hours to be worked and the duties to be performed by the Contractor's employees; and,
6. All claims on behalf of any person arising out of employment or alleged employment (including without limit claims of discrimination alleged against the Contractor, its officers, agents, or subcontractors or subcontractor's employees).

If the Contractor intends to utilize any subcontractor, the Subcontractor's level of effort, tasks, and time allocation must be clearly defined in the Contractor's bid. The Contractor shall agree that it will not utilize any Subcontractors not specifically included in its bid in the performance of the contract without the prior written authorization of the State.

The State reserves the right to require the Contractor to reassign or remove from the project any Contractor or Subcontractor employee.

Contractor shall insure that the terms and conditions contained in any contract with a sub-contractor does not conflict with the terms and conditions of this contract.

The Contractor shall include a similar provision, for the protection of the State, in the contract with any Subcontractor engaged to perform work on this contract.

B. EMPLOYEE WORK ELIGIBILITY STATUS

The Contractor is required and hereby agrees to use a federal immigration verification system to determine the work eligibility status of employees physically performing work within the State. A federal immigration verification system means the electronic verification of the work authorization program authorized by the Illegal Immigration Reform and Immigrant Responsibility Act of 1996, 8 U.S.C. 1324a, known as the E-Verify Program, or an equivalent federal

program designated by the United States Department of Homeland Security or other federal agency authorized to verify the work eligibility status of an employee.

If the Contractor is an individual or sole proprietorship, the following applies:

1. The Contractor must complete the United States Citizenship Attestation Form, available on the DAS website at <http://das.nebraska.gov/materiel/purchasing.html>

The completed United States Attestation Form should be submitted with the solicitation response.

2. If the Contractor indicates on such attestation form that he or she is a qualified alien, the Contractor agrees to provide the U.S. Citizenship and Immigration Services documentation required to verify the Contractor's lawful presence in the United States using the Systematic Alien Verification for Entitlements (SAVE) Program.
3. The Contractor understands and agrees that lawful presence in the United States is required and the Contractor may be disqualified or the contract terminated if such lawful presence cannot be verified as required by Neb. Rev. Stat. § 4-108.

C. COMPLIANCE WITH CIVIL RIGHTS LAWS AND EQUAL OPPORTUNITY EMPLOYMENT / NONDISCRIMINATION (Statutory)

The Contractor shall comply with all applicable local, state, and federal statutes and regulations regarding civil rights laws and equal opportunity employment. The Nebraska Fair Employment Practice Act prohibits Contractors of the State, and their Subcontractors, from discriminating against any employee or applicant for employment, with respect to hire, tenure, terms, conditions, compensation, or privileges of employment because of race, color, religion, sex, disability, marital status, or national origin (Neb. Rev. Stat. §§ 48-1101 through 48-1125). The Contractor guarantees compliance with the Nebraska Fair Employment Practice Act, and breach of this provision shall be regarded as a material breach of contract. The Contractor shall insert a similar provision in all Subcontracts for goods or services to be covered by any contract resulting from this solicitation.

D. COOPERATION WITH OTHER CONTRACTORS

Accept (Initial)	Reject (Initial)	Reject & Provide Alternative within Solicitation Response (Initial)	NOTES/COMMENTS:
AB			

Contractor may be required to work with or in close proximity to other contractors or individuals that may be working on the same or different projects. The Contractor shall agree to cooperate with such other contractors or individuals, and shall not commit or permit any act which may interfere with the performance of work by any other contractor or individual. Contractor is not required to compromise Contractor's intellectual property or proprietary information unless expressly required to do so by this contract.

E. DISCOUNTS

Prices quoted shall be inclusive of ALL trade discounts. Cash discount terms of less than thirty (30) days will not be considered as part of the bid. Cash discount periods will be computed from the date of receipt of a properly executed claim voucher or the date of completion of delivery of all items in a satisfactory condition, whichever is later.

F. PRICES

Prices quoted shall be net, including transportation and delivery charges fully prepaid by the contractor, F.O.B. destination named in the solicitation. No additional charges will be allowed for packing, packages, or partial delivery costs. When an arithmetic error has been made in the extended total, the unit price will govern.

All prices, costs, and terms and conditions submitted in the bid response shall remain fixed and valid commencing on the opening date of the bid until an award is made or the solicitation is cancelled.

Prices submitted on the bid response shall remain fixed for the first year of the contract. Any request for a price increase subsequent to the first year be substantiated by supporting documentation. Increases will be cumulative across the remaining periods of the contract. Requests for an increase must be submitted in writing to the State Purchasing Bureau a minimum of 120 days prior to the end of the current contract period. Documentation may be required by the State to support the price increase.

The State reserves the right to deny any requested price increase. No price increases are to be billed to any State Agencies prior to written amendment of the contract by the parties.

The State will be given full proportionate benefit of any decreases for the term of the contract.

G. COST CLARIFICATION

The State reserves the right to review all aspects of cost for reasonableness and to request clarification of any bid where the cost component shows significant and unsupported deviation from industry standards or in areas where detailed pricing is required.

H. PERMITS, REGULATIONS, LAWS

Accept (Initial)	Reject (Initial)	Reject & Provide Alternative within Solicitation Response (Initial)	NOTES/COMMENTS:
AB			

The contract price shall include the cost of all royalties, licenses, permits, and approvals, whether arising from patents, trademarks, copyrights or otherwise, that are in any way involved in the contract. The Contractor shall obtain and pay for all royalties, licenses, and permits, and approvals necessary for the performance of the contract. The Contractor must guarantee that it has the full legal right to the materials, supplies, equipment, software, and other items used to execute this contract.

I. NOTICE OF POTENTIAL CONTRACTOR BREACH

Accept (Initial)	Reject (Initial)	Reject & Provide Alternative within Solicitation Response (Initial)	NOTES/COMMENTS:
AB			

If Contractor breaches the contract or anticipates breaching the contract the Contractor shall immediately give written notice to the State. The notice shall explain the breach or potential breach, and may include a request for a waiver of the breach if so desired. The State may, at its discretion, temporarily or permanently waive the breach. By granting a temporary waiver, the State does not forfeit any rights or remedies to which the State is entitled by law or equity, or pursuant to the provisions of the contract. Failure to give immediate notice, however, may be grounds for denial of any request for a waiver of a breach.

J. ANTITRUST

Accept (Initial)	Reject (Initial)	Reject & Provide Alternative within Solicitation Response (Initial)	NOTES/COMMENTS:
AB			

The Contractor hereby assigns to the State any and all claims for overcharges as to goods and/or services provided in connection with this contract resulting from antitrust violations which arise under antitrust laws of the United States and the antitrust laws of the State.

K. CONFLICT OF INTEREST

Accept (Initial)	Reject (Initial)	Reject & Provide Alternative within Solicitation Response (Initial)	NOTES/COMMENTS:
AB			

By submitting a bid, Contractor certifies that there does not now exist a relationship between the Contractor and any person or entity which is or gives the appearance of a conflict of interest related to this solicitation or project.

The Contractor certifies that it shall not take any action or acquire any interest, either directly or indirectly, which will conflict in any manner or degree with the delivery of its goods and services hereunder or which creates an actual or an appearance of conflict of interest.

The Contractor certifies that it will not employ any individual known by Contractor to have a conflict of interest.

The Parties shall not knowingly, for a period of two (2) years after execution of the contract, recruit or employ any employee or agent of the other Party who has worked on the solicitation or project, or who had any influence on decisions affecting the solicitation or project.

L. ADVERTISING

Accept (Initial)	Reject (Initial)	Reject & Provide Alternative within Solicitation Response (Initial)	NOTES/COMMENTS:
AB			

The Contractor agrees not to refer to the contract award in advertising in such a manner as to state or imply that the company or its goods and services are endorsed or preferred by the State. Any publicity releases pertaining to the project shall not be issued without prior written approval from the State.

M. DISASTER RECOVERY/BACK UP PLAN

Accept (Initial)	Reject (Initial)	Reject & Provide Alternative within Solicitation Response (Initial)	NOTES/COMMENTS:
AB			

The Contractor shall have a disaster recovery and back-up plan, of which a copy should be provided upon request to the State, which includes, but is not limited to equipment, personnel, facilities, and transportation, in order to continue delivery of goods and services as specified under the specifications in the contract in the event of a disaster.

N. DRUG POLICY

Accept (Initial)	Reject (Initial)	Reject & Provide Alternative within Solicitation Response (Initial)	NOTES/COMMENTS:
AB			

Contractor certifies it maintains a drug free work place environment to ensure worker safety and workplace integrity. Contractor agrees to provide a copy of its drug free workplace policy at any time upon request by the State.

O. WARRANTY

Accept (Initial)	Reject (Initial)	Reject & Provide Alternative within Solicitation Response (Initial)	NOTES/COMMENTS:
			

Despite any clause to the contrary, the Contractor represents and warrants that its services hereunder shall be performed by competent personnel and shall be of professional quality consistent with generally accepted industry standards for the performance of such services and shall comply in all respects with the requirements of this Contract. For any breach of this warranty, the Contractor shall, for a period of ninety (90) days from performance of the service, perform the services again, at no cost to Customer, or if Contractor is unable to perform the services as warranted, Contractor shall reimburse Customer the fees paid to Contractor for the unsatisfactory services. The rights and remedies of the parties under this warranty are in addition to any other rights and remedies of the parties provided by law or equity, including, without limitation actual damages, and, as applicable and awarded under the law, to a prevailing party, reasonable attorneys' fees and costs.

IV. PAYMENT

A. PROHIBITION AGAINST ADVANCE PAYMENT (Statutory)

Neb. Rev. Stat. §§81-2403 states, “[no goods or services shall be deemed to be received by an agency until all such goods or services are completely delivered and finally accepted by the agency.”

B. TAXES (Statutory)

The State is not required to pay taxes and assumes no such liability as a result of this solicitation. The Contractor may request a copy of the Nebraska Department of Revenue, Nebraska Resale or Exempt Sale Certificate for Sales Tax Exemption, Form 13 for their records. Any property tax payable on the Contractor’s equipment which may be installed in a state-owned facility is the responsibility of the Contractor.

C. INVOICES

Invoices for payments must be submitted by the Contractor to the agency requesting the services with sufficient detail to support payment. The terms and conditions included in the Contractor’s invoice shall be deemed to be solely for the convenience of the parties. No terms or conditions of any such invoice shall be binding upon the State, and no action by the State, including without limitation the payment of any such invoice in whole or in part, shall be construed as binding or estopping the State with respect to any such term or condition, unless the invoice term or condition has been previously agreed to by the State as an amendment to the contract.

D. INSPECTION AND APPROVAL

Accept (Initial)	Reject (Initial)	Reject & Provide Alternative within Solicitation Response (Initial)	NOTES/COMMENTS:
AB			

Final inspection and approval of all work required under the contract shall be performed by the designated State officials.

E. PAYMENT (Statutory)

Payment will be made by the responsible agency in compliance with the State of Nebraska Prompt Payment Act (See Neb. Rev. Stat. §81-2403). The State may require the Contractor to accept payment by electronic means such as ACH deposit. In no event shall the State be responsible or liable to pay for any goods and services provided by the Contractor prior to the Effective Date of the contract, and the Contractor hereby waives any claim or cause of action for any such services.

F. LATE PAYMENT (Statutory)

The Contractor may charge the responsible agency interest for late payment in compliance with the State of Nebraska Prompt Payment Act (See Neb. Rev. Stat. §§ 81-2401 through 81-2408).

G. SUBJECT TO FUNDING / FUNDING OUT CLAUSE FOR LOSS OF APPROPRIATIONS (Statutory)

The State’s obligation to pay amounts due on the Contract for a fiscal years following the current fiscal year is contingent upon legislative appropriation of funds. Should said funds not be appropriated, the State may terminate the contract with respect to those payments for the fiscal year(s) for which such funds are not appropriated. The State will give the Contractor written notice thirty (30) calendar days prior to the effective date of termination. All obligations of the State to make payments after the termination date will cease. The Contractor shall be entitled to receive just and equitable compensation for any authorized work which has been satisfactorily completed as of the termination date. In no event shall the Contractor be paid for a loss of anticipated profit.

H. RIGHT TO AUDIT (First Paragraph is Statutory)

The State shall have the right to audit the Contractor’s performance of this contract upon a thirty (30) day written notice. Contractor shall utilize generally accepted accounting principles, and shall maintain the accounting records, and other records and information relevant to the contract (Information) to enable the State to audit the contract. (Neb. Rev. Stat. § 84-304 et seq.) The State may audit and the Contractor shall maintain the information during the term of the contract and for a period of five (5) years after the completion of this contract or until all issues or litigation are resolved, whichever is later. The Contractor shall make the information available to the State at Contractor’s place of business or a location acceptable to both Parties during normal business hours. If this is not practical or the Contractor so elects, the Contractor may provide electronic or paper copies of the Information. The State reserves the right to examine, make copies of, and take notes on any Information relevant to this contract, regardless of the

form or the Information, how it is stored, or who possesses the Information. In no circumstances will contractor be required to create or maintain documents not kept in the ordinary course of contractor's business operations, nor will contractor be required to disclose any information, including but not limited to product cost data, which is confidential or proprietary to contractor.

Accept (Initial)	Reject (Initial)	Reject & Provide Alternative within Solicitation Response (Initial)	NOTES/COMMENTS:
AB			

The Parties shall pay their own costs of the audit unless the audit finds a previously undisclosed overpayment by the State. If a previously undisclosed overpayment exceeds three percent (3%) of the total contract billings, or if fraud, material misrepresentations, or non-performance is discovered on the part of the Contractor, the Contractor shall reimburse the State for the total costs of the audit. Overpayments and audit costs owed to the State shall be paid within ninety (90) days of written notice of the claim. The Contractor agrees to correct any material weaknesses or condition found as a result of the audit.

V. SCOPE OF WORK

The Contractor must provide the following information in response to this solicitation.

A. SCOPE

It is the intent of this bid invitation to establish a contract to supply Truck Mounted Sequential Flashing Arrow Board per the attached specifications from date of award for a period of One (1) years with the option to renew for an additional Four (4) one year periods when mutually agreeable to the contractor and the State. The State reserves the right to extend the period of this contract beyond the end date when mutually agreeable to the contractor and the State.

All items proposed shall be of the latest manufacture in production as of the date of the solicitation and be of proven performance and under standard design complete as regularly advertised and marketed. All necessary materials for satisfactory performance of the supplies shall be incorporated into the Truck Mounted Sequential Flashing Arrow Board whether or not they may be specifically mentioned below.

Complete specifications, manufacturer's current descriptive literature and/or advertising data sheets with cuts or photographs must be included with the bid response for the IDENTICAL items proposed. Any information necessary to show compliance with these specifications not given on the manufacturer's descriptive literature and/or advertising data sheets must be supplied in writing on or attached to the bid document. If manufacturer's information necessary to show compliance with these specifications is not attached to the bid document, the Contractor may be required to submit requested information within three (3) business days of a written request. Failure to submit requested descriptive literature or advertising data sheets may be grounds to reject the bid.

VI. TECHNICAL SPECIFICATIONS

A. CONTRACTOR INSTRUCTIONS

Contractor must respond to each of the following statements. Specifications listed are minimum conditions that must be met in order for a Contractor to qualify for the award.

“YES” response means the Contractor guarantees they can meet this condition.

“NO” response means the Contractor cannot meet this condition and will not be considered.

“NO & PROVIDE ALTERNATIVE” responses should be used only with a narrative response in the NOTES/COMMENTS section explaining in detail any deviation from the Contractor’s ability to meet the condition, and an explanation of how this would be determined to be an acceptable alternative to meeting the condition. Alternatives must be detailed in such a way that allows such deviations to be fully evaluated. The State shall determine at its sole discretion whether or not the Contractor’s alternative is an acceptable alternative.

B. NON-COMPLIANCE STATEMENT

YES	NO	NO & PROVIDE ALTERNATIVE	
X			1. Read these specifications carefully. Any and all exceptions to these specifications must be written on or attached to solicitation response. Any noncompliance may void your bid response. Non-compliance to any single specification can void your bid.
X			2. It is the responsibility of Contractors to obtain information and clarifications as provided below. The State is not responsible for any erroneous or incomplete understandings or wrongful interpretations of this solicitation by any Contractor.
X			3. No interpretation related to the meaning of solicitation specifications or other pre-bid response documents will be made orally to any Contractor by the State. Any solicitation interpretation must be put in writing by the Contractor to: the State Purchasing Bureau, E-mail questions to SPB. as.materielpurchasing@nebraska.gov by the last day to submit written questions per the Schedule of Events. (Inquiries received after the last day to submit written questions may not be addressed).
NOTES/COMMENTS:			

C. GENERAL SPECIFICATIONS

YES	NO	NO & PROVIDE ALTERNATIVE	
X			1. The Arrow board shall be capable of 12 arrow patterns. a. 5 flashing and 7 sequential arrow patterns.
X			2. Unit shall have a SKID MOUNTED frame.
X			3. Arrow board shall have a minimum of 25 hooded LED lights.
X			4. Arrow board dimensions shall be approximately 48 inches by 96 inches.
X			5. It shall be 12 volt with solid state circuitry and a minimum flash rate of 30 F.P.M.

X			6. A plug in controller shall be furnished in a lockable weather resistant box. a. Will feature 4 manual selections for dimming – 100%, 60%, 50% and 35% or automatic dimming feature. b. Minimum 40 foot harness.
X			7. Unit must meet MUTCD Specifications [Manual on Uniform Traffic Control Devices for Streets and Highways published by the Federal Highway Administration (FHWA) under 23 Code of Federal Regulations (CFR), Part 655, Subpart F].
NOTES/COMMENTS:			

D. MANUALS

YES	NO	NO & PROVIDE ALTERNATIVE	
X			1. One complete set of operation manuals shall be supplied at delivery for each unit shipped.
X			2. All manuals must be delivered to Fleet Management Equipment Data Coordinator and received prior to payment. Failure to deliver all manuals that are ordered may result in non-payment of ten percent of purchase order total until all manuals are delivered.
NOTES/COMMENTS:			

E. MISCELLANEOUS

YES	NO	NO & PROVIDE ALTERNATIVE	
X			1. Dealer's decals, stickers or other such signs shall not be put on units; manufacturer's nameplates, stampings and other similar signs are acceptable.
X			2. The manufacturer's usual warranty shall apply and must be in effect for a minimum of one year.
X			3. Warranty statement must be included with proposal.
NOTES/COMMENTS: K & K SYSTEMS, INC. STANDARD WARRANTY IS 1 YEAR. K & K SYSTEMS, INC. IS INCLUDING A 2 YEAR WARRANTY			

OPTIONS:

F. SOLAR POWER

YES	NO	NO & PROVIDE ALTERNATIVE	
X			1. Solar power, complete with solar panel or panels, battery packs in weather tight battery box and all necessary circuitry to charge batteries.
NOTES/COMMENTS:			

G. 30 X 60 INCH

YES	NO	NO & PROVIDE ALTERNATIVE	
X			1. The Arrow board shall be capable of 12 arrow patterns. a. 5 flashing and 7 sequential arrow patterns.
X			2. Unit shall have a SKID MOUNTED frame.
X			3. Arrow board shall have a minimum of 25 hooded LED lights.
X			4. Arrow board dimensions shall be approximately 30 inches by 60 inches
X			5. It shall be 12 volt with solid state circuitry and a minimum flash rate of 30 F.P.M.
X			6. A plug in controller shall be furnished in a lockable weather resistant box. a. Will feature 4 manual selections for dimming – 100%, 60%, 50% and 35% or automatic dimming feature. b. Minimum 40 foot harness.
X			7. Unit must meet MUTCD Specifications.
NOTES/COMMENTS:			

H. WIRELESS REMOTE

YES	NO	NO & PROVIDE ALTERNATIVE	
X			1. Remote to operate arrow board and power tilt.
NOTES/COMMENTS:			

I. POWER TILT

YES	NO	NO & PROVIDE ALTERNATIVE	
X			1. 90 degree tilt frame to allow board to face traffic or face downward when not in use. Electric actuator to tilt the frame.
X			2. Low profile 90 degree tilt if available. Electric actuator to tilt the frame. Please state approximate height when tilted. _____
NOTES/COMMENTS:			

J. ANNUAL USAGE, ESTIMATED

YES	NO	NO & PROVIDE ALTERNATIVE	
X			1. Annual usage figures provided are estimates and are not to be construed as either a minimum or maximum purchase quantity. The orders shall be for the actual quantities of each item ordered by or for any agency during the life of the contract. Contractor shall not impose minimum order requirements.
X			2. Ten (10) 48 inch x 96 inch units estimated.
X			3. Ten (10) 30 inch x 60 inch units estimated.
NOTES/COMMENTS:			

K. USAGE REPORT

YES	NO	NO & PROVIDE ALTERNATIVE	
X			1. The contractor shall, upon request, provide a quarterly usage report of this contract by state agencies and political subdivisions. Information will include agency name, item, and dollar amount. Information may be requested at any time by the SPB, as determined by the State.
NOTES/COMMENTS:			

L. DELIVERY ARO

YES	NO	NO & PROVIDE ALTERNATIVE	
X			1. Delivery desired within 90 days after receipt of order(s).
NOTES/COMMENTS:			

M. DELIVERY LOCATIONS / INSTRUCTIONS (CONTRACTOR AGREES THAT THEY CAN MEET THE DELIVERY LOCATIONS/INSTRUCTIONS)

YES	NO	NO & PROVIDE ALTERNATIVE	
X			1. NDOT 5001 S 14 th Street Lincoln, NE 68512 Contact: Mike Blacksher 402-479-4319
NOTES/COMMENTS:			

N. ORDERS

YES	NO	NO & PROVIDE ALTERNATIVE	
X			1. Orders will be placed either by, phone, e-mail or Internet (if available and not to the exclusion of the other methods).
NOTES/COMMENTS:			

O. QUALITY

YES	NO	NO & PROVIDE ALTERNATIVE	
X			1. Product quality must meet specifications and be consistent for the term of the contract. All materials must be of first quality, under standard production by the manufacturer and be of standard design, complete as regularly advertised and marketed and be of proven performance.
X			2. A guarantee of satisfactory performance by the contractor and meeting delivery dates are considered to be an integral part of the purchase contract resulting from this proposal invitation.
X			3. Products are to be fully guaranteed and may be returned for full credit or replacement (at the State's option) for any reason during the initial warranty period with no additional charges for shipping or restocking.

NOTES/COMMENTS:

P. AUTHORIZED DEALER & WARRANTY

YES	NO	NO & PROVIDE ALTERNATIVE	
X			1. To the extent required by the manufacturer, the Contractor shall be an authorized dealer. Contractor may be required to substantiate that he/she is an authorized dealer. Proof, if required, must be submitted to SPB within three (3) business days of the request and prior to the award of any contract.
X			2. The terms of the original manufacturer's standard warranty shall apply to all equipment acquired from this solicitation for the entire warranty period.

NOTES/COMMENTS:

Q. WARRANTY

YES	NO	NO & PROVIDE ALTERNATIVE	
X			1. The Contractor warrants for a period of one (1) year from the date of Acceptance that: (a) the Products perform according to all specific claims that the Contractor made in its response to the solicitation, (b) the Product is suitable for the ordinary purposes for which such Product is used, (c) the Product is suitable for any special purposes identified in the solicitation or for which the State has relied on the Contractor's skill or judgment, (d) the Product is designed and manufactured in a commercially reasonable manner, and (e) the Product is free of defects. Upon breach of the warranty, the Contractor will repair or replace (at no charge to the State) the Product whose nonconformance is discovered and made known to the Contractor. If the repaired and/or replaced Product proves to be inadequate, or fails of its essential purpose, the Contractor will refund the full amount of any payments that have been made. The rights and remedies of the parties under this warranty are in addition to any other rights and remedies of the parties provided by law or equity, including, without limitation actual damages, and, as applicable and awarded under the law, to a prevailing party, reasonable attorneys' fees and costs.

NOTES/COMMENTS:

Form A
Contractor Contact Sheet
Invitation To Bid Number 6039 OF

Form A should be completed and submitted with each bid response to this solicitation. This is intended to provide the State with information on the Contractor's name and address, and the specific person(s) who are responsible for preparation of the Contractor's response.

Preparation of Bid Response Contact Information	
Contractor Name:	K & K SYSTEMS, INC.
Contractor Address:	687 PALMETTO ROAD TUPELO, MS 38801
Contact Person & Title:	ALICE K. BINGHAM, ACCOUNT MANAGER
E-mail Address:	ali@k-systems.com
Telephone Number (Office):	888-414-3003 OR 662-566-2025
Telephone Number (Cellular):	
Fax Number:	662-566-7123

Each Contractor shall also designate a specific contact person who will be responsible for responding to the State if any clarifications of the Contractor's response should become necessary.

Communication with the State Contact Information	
Contractor Name:	K & K SYSTEMS, INC.
Contractor Address:	687 PALMETTO ROAD TUPELO, MS 38801
Contact Person & Title:	ALICE K. BINGHAM, ACCOUNT MANAGER
E-mail Address:	ali@k-systems.com
Telephone Number (Office):	888-414-3003 OR 662-566-2025
Telephone Number (Cellular):	
Fax Number:	662-566-2025

ADDENDUM ONE, QUESTIONS and ANSWERS

Date: June 06, 2019

To: All Bidders

From: Rene Botts, Buyer
AS Materiel State Purchasing

RE: Addendum for Invitation to Bid Number 6093 OF to be opened June 18, 2019 at 2:00 p.m. Central Time.

Questions and Answers

Following are the questions submitted and answers provided for the above mentioned Invitation to Bid. The questions and answers are to be considered as part of the Invitation to Bid. It is the Bidder's responsibility to check the State Purchasing Bureau website for all addenda or amendments.

<u>Question Number</u>	<u>ITB Page Number</u>	<u>Question</u>	<u>State Response</u>
1.	Price Page	<p>The ITB requests price for 48"x96" and 30"x60" arrowboards (line item 1 & 2). Line item requests price for "Power Tilt".</p> <p>Question~ Power Tilt for which arrowboard, 48"x96" or 30"x60"?</p> <p>Note: The Power Tilt for 48"x96" and the 30"x60" arrowboards are not the same in size, configuration or price.</p>	<p>The State of Nebraska would like a price quotes for both arrow boards (48x96 and 30x60) Power tilts.</p> <p>Bidders may add pricing on the ITB form or as a separate document with their submitted bid. Bidders may include pricing for power tilt add-ons by size and any other equipment and pricing associated to Sequential Flashing Arrow Boards that the bidder is offering the State of Nebraska for purchase in their bid response.</p>
2.		<p>Are the arrow boards required to have the four(4) manual dimming selection?(100,60,50 and 35 percents)</p>	<p>Please comply with specifications as written.</p> <p>Section VI; C. General Specifications, Item 6.a.</p> <p style="padding-left: 20px;">a. Will feature 4 manual selections for dimming – 100%, 60%, 50% and 35% or automatic dimming feature.</p>
		<p>Is a wireless power tilt remote option required?</p>	<p>Yes, a wireless power tilt remote is required.</p>

		<p>Our smaller arrow board is 36" x 72", will this be sufficient in place of a 30" x 60" arrow board?</p>	<p>The State of Nebraska prefers the smaller arrow board dimensions be 30" x 60".</p> <p>And bidders may offer pricing and details on any equipment related to or associated to Sequential Flashing Arrow Boards to the State of Nebraska for purchase in their bid response.</p>
--	--	--	---

This addendum will become part of the ITB and should be acknowledged with the Invitation to Bid response.